

Field Assessment of Air Barriers at the Building Envelope Systems Test (BEST) Laboratory – Phase 1

September 2011

Prepared by

**Diana Hun
Andre Desjarlais
Phil Childs
Jerry Atchley
Achilles Karagiozis**

DOCUMENT AVAILABILITY

Reports produced after January 1, 1996, are generally available free via the U.S. Department of Energy (DOE) Information Bridge.

Web site <http://www.osti.gov/bridge>

Reports produced before January 1, 1996, may be purchased by members of the public from the following source.

National Technical Information Service
5285 Port Royal Road
Springfield, VA 22161
Telephone 703-605-6000 (1-800-553-6847)
TDD 703-487-4639
Fax 703-605-6900
E-mail info@ntis.gov
Web site <http://www.ntis.gov/support/ordernowabout.htm>

Reports are available to DOE employees, DOE contractors, Energy Technology Data Exchange (ETDE) representatives, and International Nuclear Information System (INIS) representatives from the following source.

Office of Scientific and Technical Information
P.O. Box 62
Oak Ridge, TN 37831
Telephone 865-576-8401
Fax 865-576-5728
E-mail reports@osti.gov
Web site <http://www.osti.gov/contact.html>

This report was prepared as an account of work sponsored by an agency of the United States Government. Neither the United States Government nor any agency thereof, nor any of their employees, makes any warranty, express or implied, or assumes any legal liability or responsibility for the accuracy, completeness, or usefulness of any information, apparatus, product, or process disclosed, or represents that its use would not infringe privately owned rights. Reference herein to any specific commercial product, process, or service by trade name, trademark, manufacturer, or otherwise, does not necessarily constitute or imply its endorsement, recommendation, or favoring by the United States Government or any agency thereof. The views and opinions of authors expressed herein do not necessarily state or reflect those of the United States Government or any agency thereof.

Energy and Transportation Science Division

**Field Assessment of Air Barriers at
the Building Envelope Systems Test (BEST) Laboratory
Phase 1**

Diana Hun
Andre Desjarlais
Phil Childs
Jerry Atchley
Achilles Karagiozis

Date Published: September 2011

Prepared by
OAK RIDGE NATIONAL LABORATORY
Oak Ridge, Tennessee 37831-6283
managed by
UT-BATTELLE, LLC
for the
U.S. DEPARTMENT OF ENERGY
under contract DE-AC05-00OR22725

TABLE OF CONTENTS

1. Introduction	1
2. BEST Laboratory.....	1
2.1. Laboratory Equipment	2
3. Panel Material and Sensor Layout.....	3
4. Experimental Procedures.....	19
5. Results	20
6. References	42
Appendix A: North Panels	43
Appendix B: East Panels.....	91
Appendix C: South Panels	139
Appendix D: West Panels	187
Appendix E: Solar Radiation	235
Appendix F: Wind Speed.....	251
Appendix G: Rain	267
Appendix H: Pressure Differential.....	271

Field Assessment of Air Barriers at the Building Envelope Systems Testing (BEST) Laboratory Phase 1

1. Introduction

The Buildings Technologies Research and Integration Center (BTRIC) at the Oak Ridge National Laboratory (ORNL) performed field evaluations of 24 wall panels with different types of air barriers that are commonly used in residential and commercial construction. Field assessments were conducted from September 2009 until August 2010 at the Building Envelope Systems Test (BEST) laboratory, which is located at Syracuse University, Syracuse, NY. This project is a cooperative research among ORNL, the Air Barrier Association of America (ABAA), Syracuse University, and the New York State Energy Research and Development Authority (NYSERDA).

The 12-month data presented in this report is intended to be used to evaluate the energy and moisture performance of wall panels as individual specimens. ORNL measurements complement air leakage rates reported by Syracuse University for each of the panels (Pradhan et al. 2011). The data should not be used to compare the performance of different air barrier types because the panels were not designed for this purpose. Multiple factors varied among specimens such as the building materials used and their layout, as well as the location of the panel in the test hut. Furthermore, the installation of the air barrier assemblies was performed by representatives from 11 manufacturers, which introduced discrepancies in workmanship.

2. BEST Laboratory

The BEST lab is a two-story facility where up to 34 wall panels can be exposed to controlled indoor conditions (i.e., temperature) and the outdoor environment (Figure 1). The laboratory is equipped with a weather station that monitors temperature, relative humidity, solar radiation, rain accumulation, wind speed and direction, and atmospheric pressure.



Figure 1. Building Envelope Systems Testing (BEST) lab.

2.1. Laboratory Equipment

Laboratory monitoring instruments include:

1. Temperature: Honeywell/Fenwal 192-103LET-A01 thermistor ($\pm 0.2\%$ accuracy).
2. Relative humidity: Honeywell HIH-4000 Series ($\pm 3.5\%$ accuracy and $\pm 0.5\%$ repeatability).
3. Dataloggers: Campbell Scientific CR1000.
4. Multiplexers: Campbell Scientific AM16/32.
5. Pressure: Energy Conservatory Automated Performance Testing system (resolution: 0.1 Pa; accuracy: $\pm 1\%$ of reading or twice the resolution, whichever is greater)

Weather station instruments are:

1. Temperature: Campbell Scientific CS215 (accuracy: $\pm 0.3\text{ }^{\circ}\text{C}$ at $25\text{ }^{\circ}\text{C}$; $\pm 0.4\text{ }^{\circ}\text{C}$ over $25\text{ }^{\circ}\text{C}$ to $40\text{ }^{\circ}\text{C}$; $\pm 0.9\text{ }^{\circ}\text{C}$ over $40\text{ }^{\circ}\text{C}$ to $70\text{ }^{\circ}\text{C}$).
2. Relative humidity: Campbell Scientific CS215 (accuracy at $25\text{ }^{\circ}\text{C}$: $\pm 2\%$ over 10% to 90% RH, and $\pm 4\%$ over 90% to 100% RH).
3. Wind speed: Gill Windsonic 1 ($\pm 2\%$ accuracy at 12 m/s).
4. Wind direction: Gill Windsonic 1 ($\pm 3^{\circ}$ accuracy at 20 m/s).
5. Rainfall: Texas Electronics TE525WS ($\pm 1\%$ accuracy at up to 2.54 cm/hr).
6. Total solar radiation flux: Hukseflux LP02.
7. Solar radiation on vertical surfaces: Campbell Scientific LI200X pyranometer.

8. Atmospheric pressure: Vaisala CS106 (accuracy: ± 0.3 mb at 20 °C; ± 0.6 mb over 20 °C to 40 °C; ± 1.5 mb over 40 °C to 60 °C).

Monitoring instruments within wall panels:

1. Temperature: Honeywell/Fenwal 192-103LET-A01 thermistor ($\pm 0.2\%$ accuracy).
When installed in conjunction with a relative humidity sensor and in a location where the instruments could get wet (e.g., behind the cladding), the sensors were protected with a membrane that was impermeable to water and had a high water vapor permeability.
2. Relative humidity: Honeywell HIH-4000 Series ($\pm 3.5\%$ accuracy and $\pm 0.5\%$ repeatability). When installed in a location where the instruments could get wet (e.g., behind the cladding), the sensors were protected with a membrane that was impermeable to water and had a high water vapor permeability.
3. Heat flux: Concept Engineering Model F-002-4.

3. Panel Material and Sensor Layout

Twenty-four panels were monitored in Phase 1 at the BEST lab. Figure 2 illustrates the arrangement of the panels in the building as well as the air barrier type utilized in them. The materials that were used in each of the panels are described in Table 1 and in more detail in Figures 3 to 24.

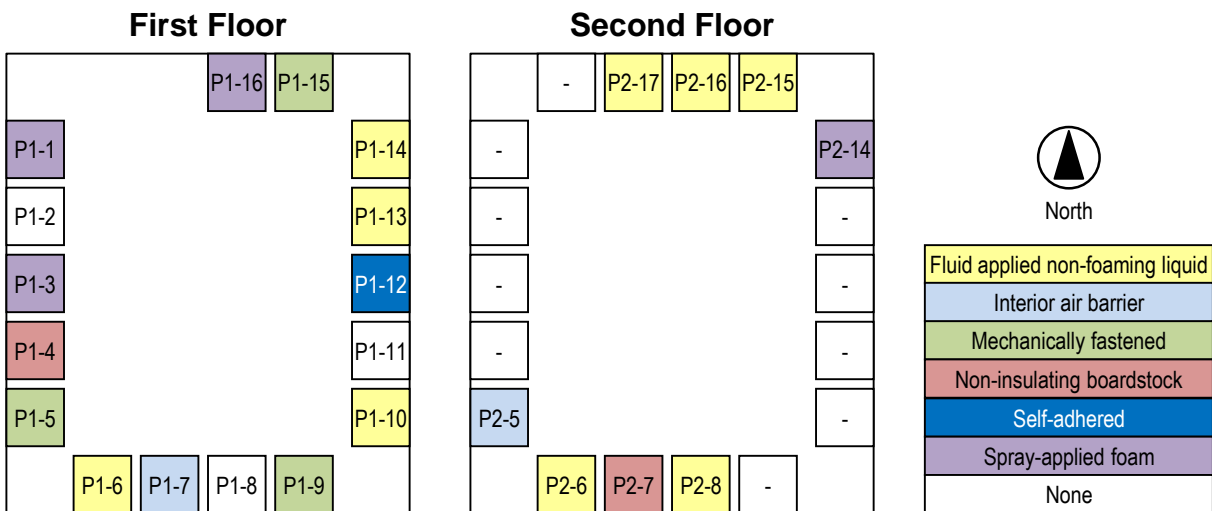

Figure 2. Panel layout at the BEST lab. The figure also illustrates the air barrier types utilized in the panels.

Table 1. Building materials and sensor layout in wall panels^a.

Panel	ID ^b	Air Barrier Type	Cladding	Structural Framing	Exterior Sheathing	Insulation	Sensor Layout ^c
P1-1	AB13	Spray-applied foam	Brick	8" CMU	-	2 ½" Spray foam	C
P1-2	-	No air barrier (control)	-	8" split-faced CMU	-	-	D
P1-3	AB27	Spray-applied foam	Vinyl siding	2×6 wood studs	OSB	Spray foam	B
P1-4	AB16	Non-insulating boardstock	Stone	2×6 wood studs	OSB	R-21 Faced fiberglass	A
P1-5	AB19	Mechanically fastened membrane	Stone	6" steel studs	Gypsum w/ fiberglass mat	R-21 Faced fiberglass	A
P1-6	AB9	Fluid-applied non-foaming liquid	Brick	6" steel studs	Gypsum w/ fiberglass mat	R-10 XPS rigid foam	A
P1-7	AB23	Interior air barrier	Brick	6" steel studs	Gypsum w/ fiberglass mat	R-21 Unfaced fiberglass and 1" XPS rigid insulation	A
P1-8	-	No air barrier (control)	Brick	6" steel studs	Gypsum w/ fiberglass mat	R-21 Faced fiberglass	B
P1-9	AB6	Mechanically fastened membrane	Brick	6" steel studs	Gypsum w/ fiberglass mat	R-21 Faced fiberglass	B
P1-10	AB24	Fluid-applied non-foaming liquid	Brick	8" CMU	-	R-10 XPS Rigid foam	C
P1-11	-	No air barrier (control)	Brick	8" CMU	-	-	C
P1-12	AB20	Self-adhered membrane	Brick	6" steel studs	Gypsum w/ fiberglass mat	R-10 XPS Rigid foam	A
P1-13	AB21	Fluid-applied non-foaming liquid	Brick	6" steel studs	Gypsum w/ fiberglass mat	R-21 Faced fiberglass	A
P1-14	AB2	Fluid-applied non-foaming liquid	Brick	6" steel studs	Gypsum w/ fiberglass mat	R-21 Faced fiberglass	A
P1-15	AB25	Mechanically fastened membrane	Thin brick	6" steel studs	Gypsum w/ fiberglass mat	R-21 Faced fiberglass	A
P1-16	AB13	Spray-applied foam	Brick	6" steel studs	Gypsum w/ fiberglass mat	2 ½" Spray foam	A
P2-5	AB23	Interior air barrier	Fiber cement siding	2×6 wood studs	-	R-21 Unfaced fiberglass	B
P2-6	AB10	Fluid-applied non-foaming liquid	Metal panel	6" steel studs	Gypsum w/ fiberglass mat	R-21 Faced fiberglass	A
P2-7	AB16	Non-insulating boardstock	Fiber cement siding	2×6 wood studs	OSB	R-21 Faced fiberglass	B
P2-8	AB7	Fluid-applied non-foaming liquid	Stucco	6" steel studs	Gypsum w/ fiberglass mat	R-21 Faced fiberglass	A
P2-14	AB26	Spray-applied foam	Vinyl siding	2×6 wood studs	-	Spray foam	A
P2-15	AB4	Fluid-applied non-foaming liquid	Fiber cement siding	2×6 wood studs	OSB	R-21 Faced fiberglass	A
P2-16	-	No air barrier (control)	Stucco	6" steel studs	Gypsum w/ fiberglass mat	R-21 EPS rigid foam	B
P2-17	AB8-2	Fluid-applied non-foaming liquid	Stucco	6" steel studs	Gypsum w/ fiberglass mat	R-21 EPS rigid foam	B

- a. All panels, except P1-2, had drywall with latex paint on their interior side. In P1-2, the interior side of the CMU was coated with latex paint.
- b. Panel ID used in the report “Air Leakage Measurement of 25 Wall Assemblies with Different Types of Air Barriers” (Pradhan et al. 2011).
- c. Sensor layouts are depicted in Figures 25 through 28.

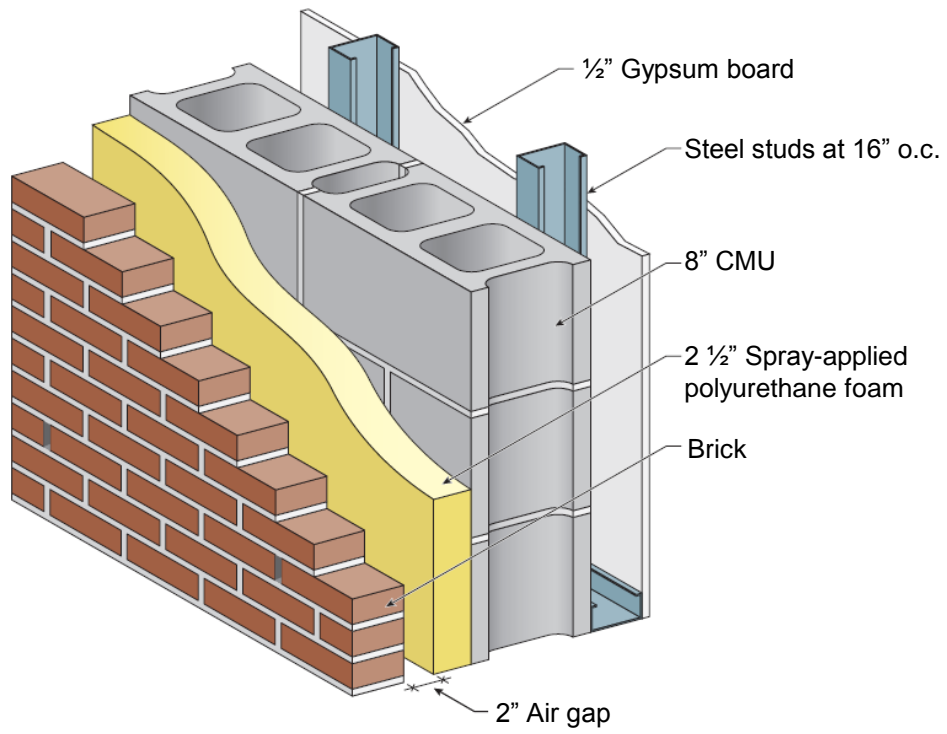

Figure 3. Material layout in panel P1-1.

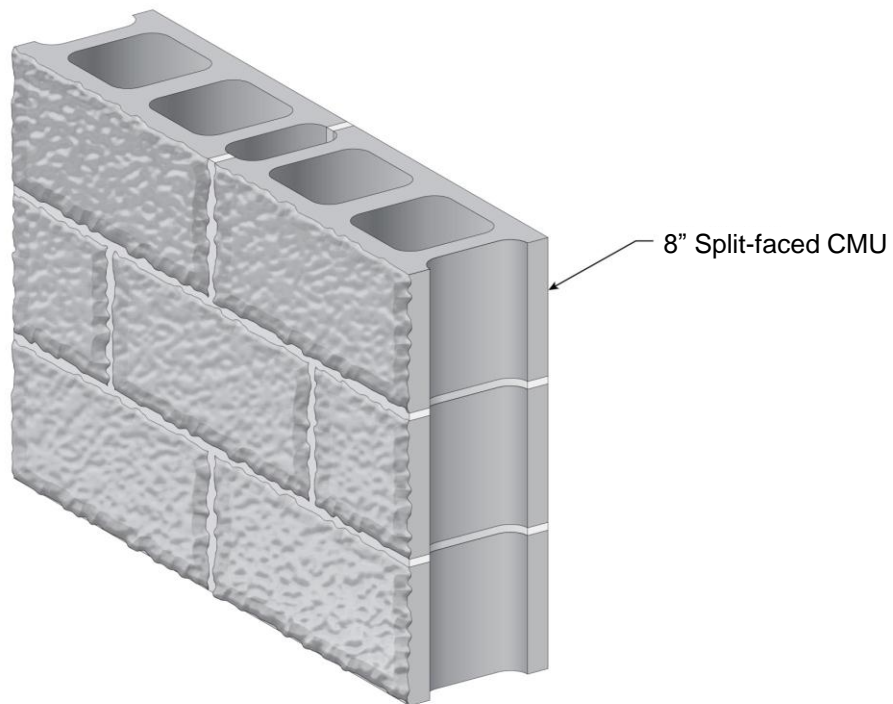

Figure 4. Material layout in panel P1-2 (control).

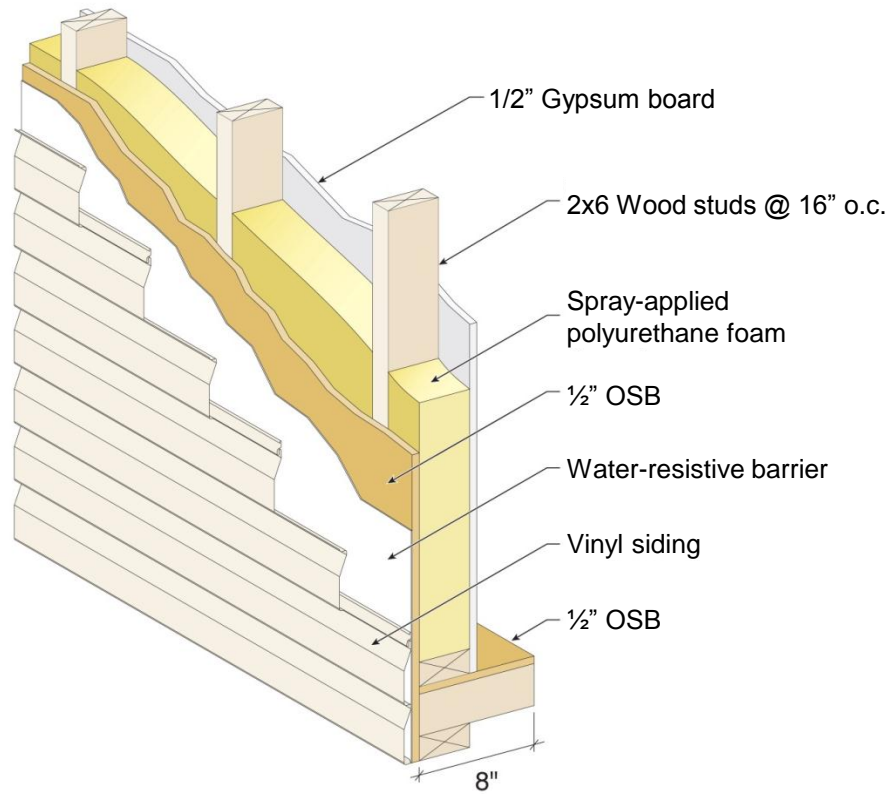

Figure 5. Material layout in panels P1-3 and P2-14.

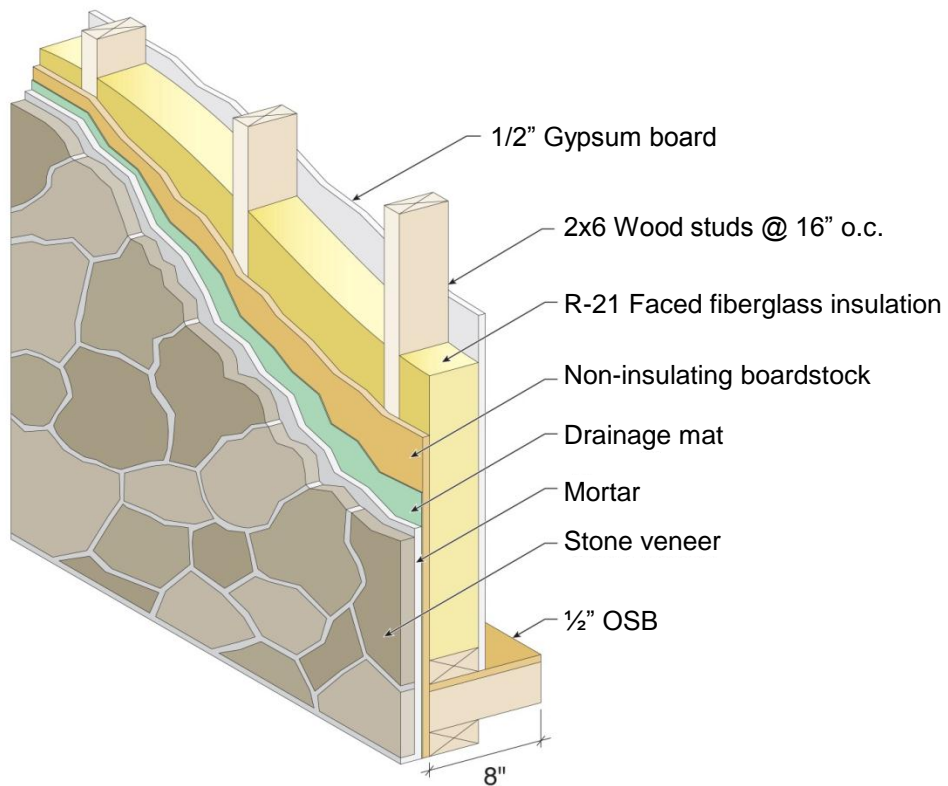

Figure 6. Material layout in panel P1-4

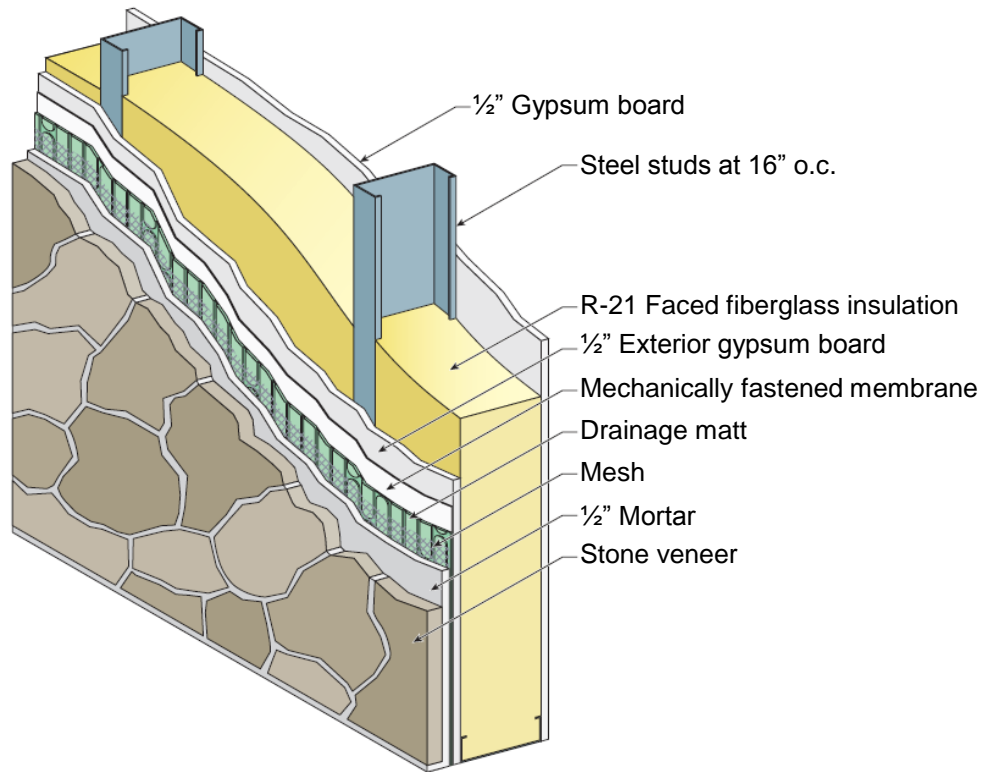

Figure 7. Material layout in panel P1-5.

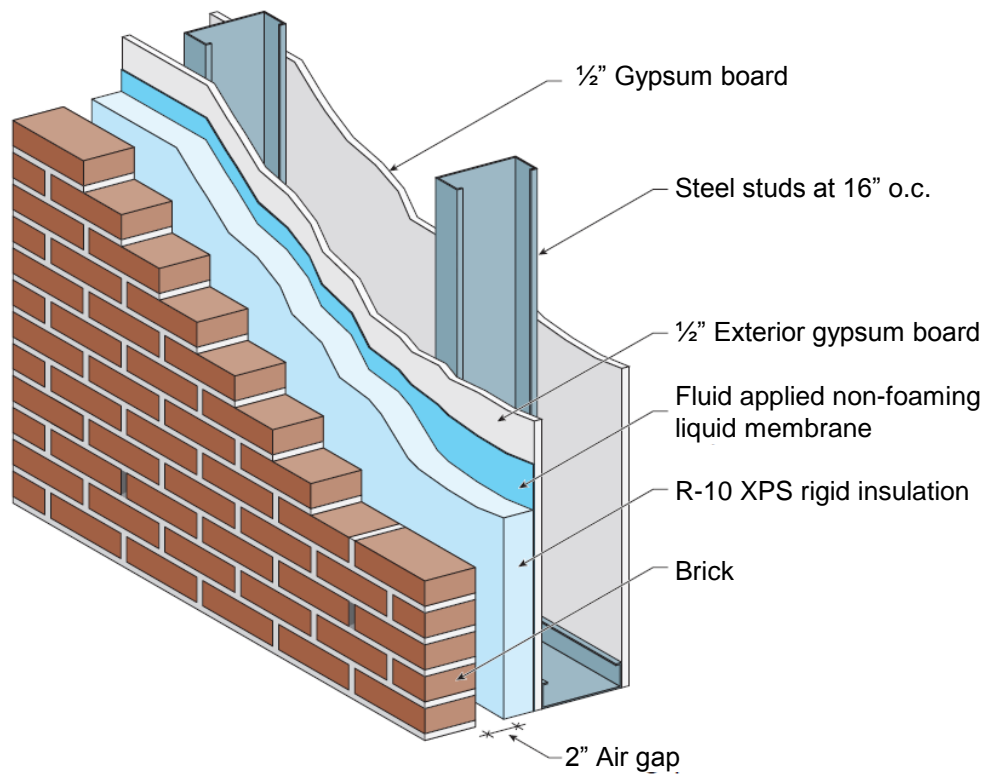

Figure 8. Material layout in panel P1-6.

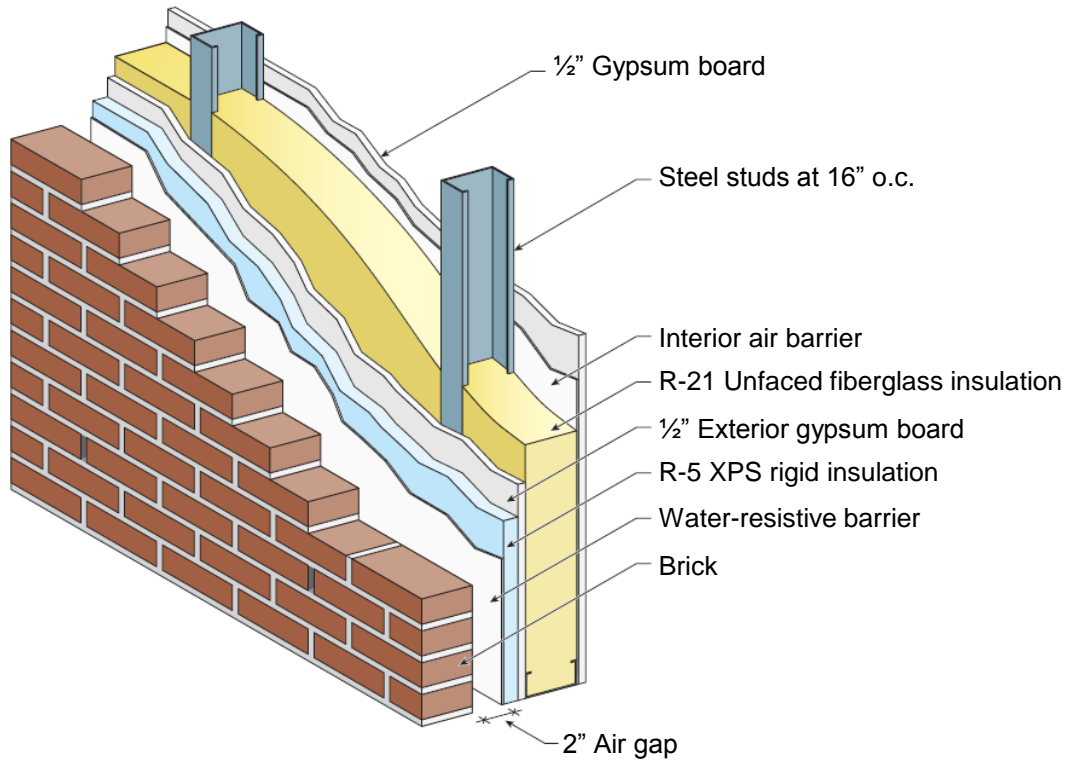

Figure 9. Material layout in panel P1-7.

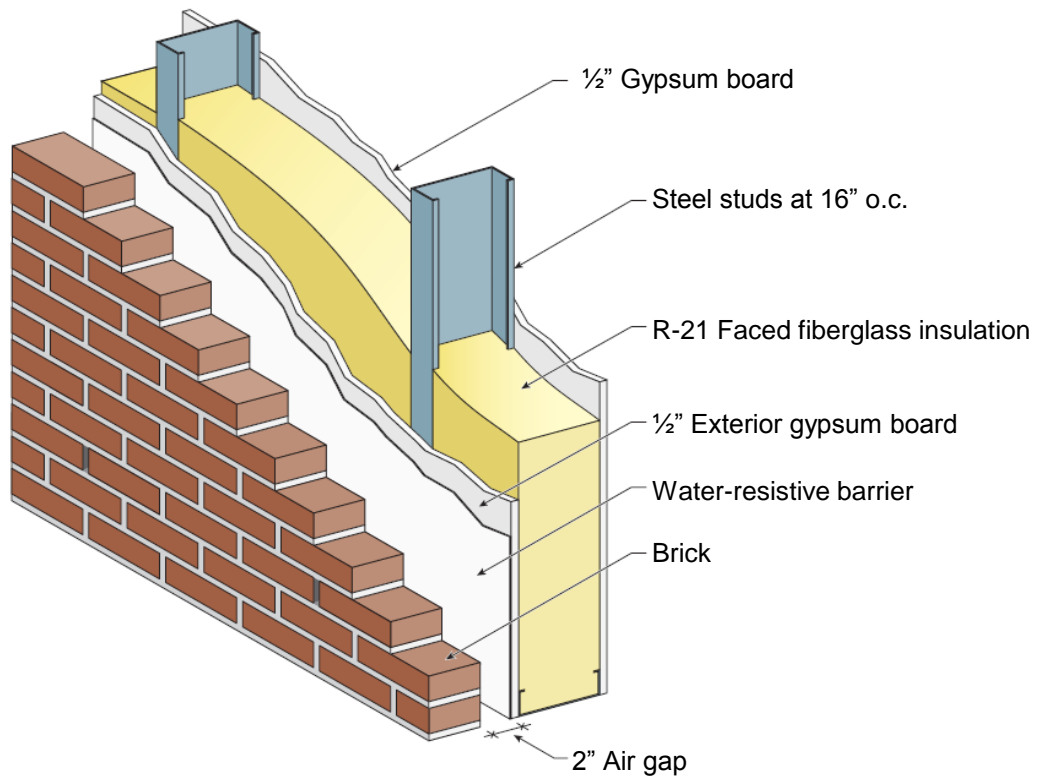

Figure 10. Material layout in panel P1-8 (control).

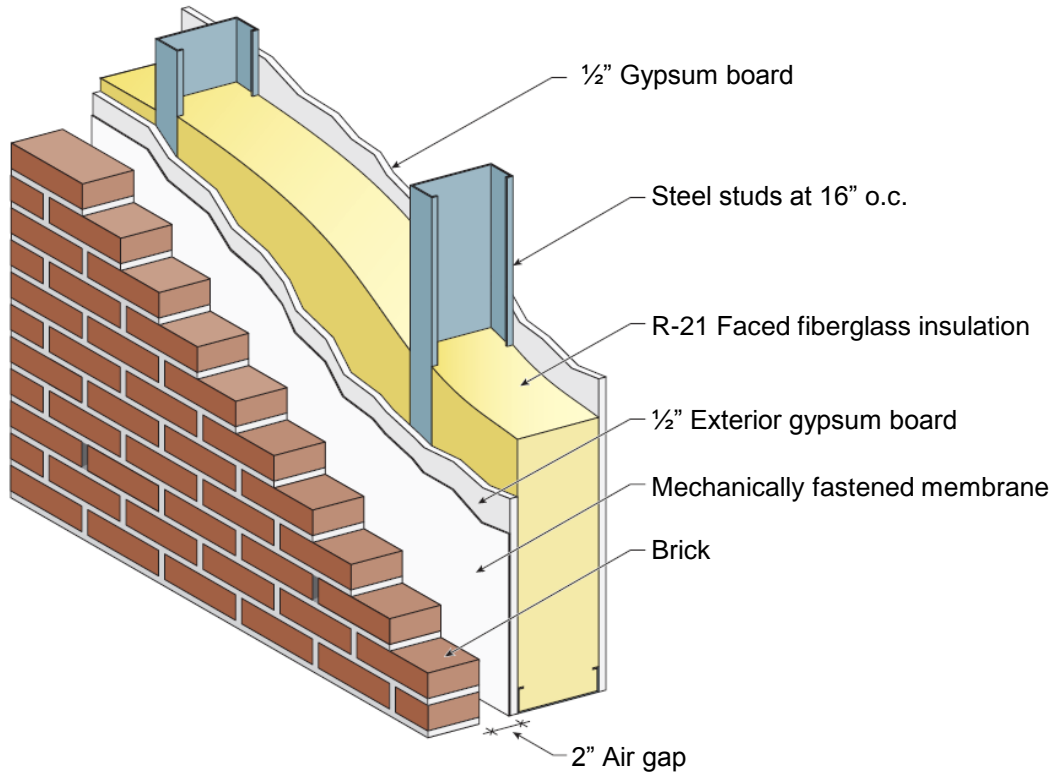

Figure 11. Material layout in panel P1-9.

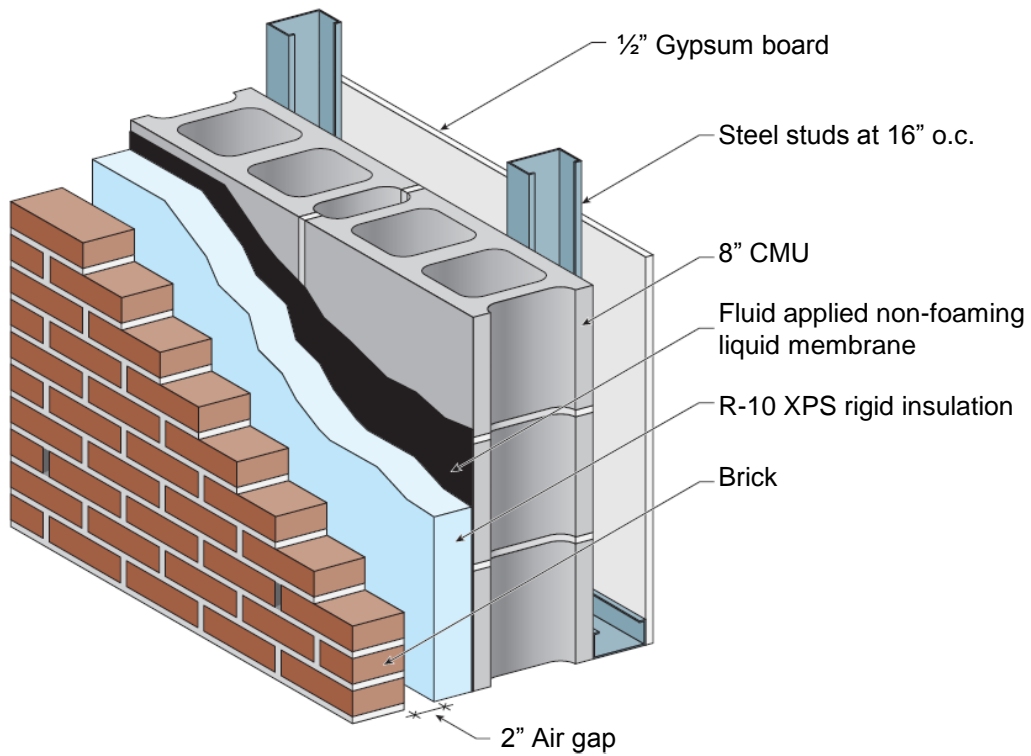

Figure 12. Material layout in panel P1-10.

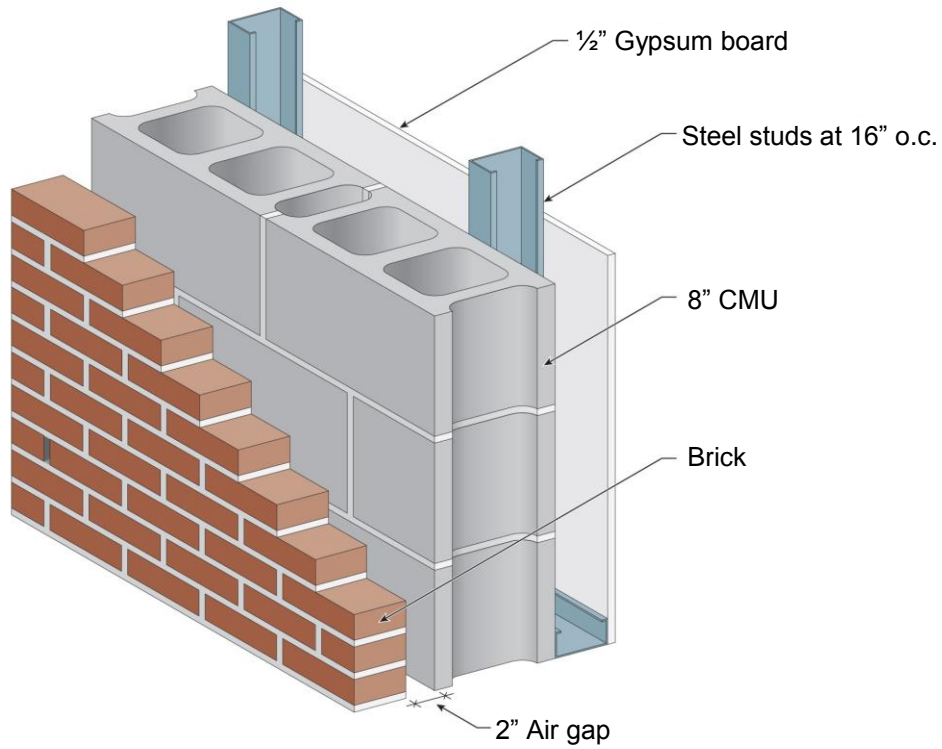

Figure 13. Material layout in panel P1-11 (control).

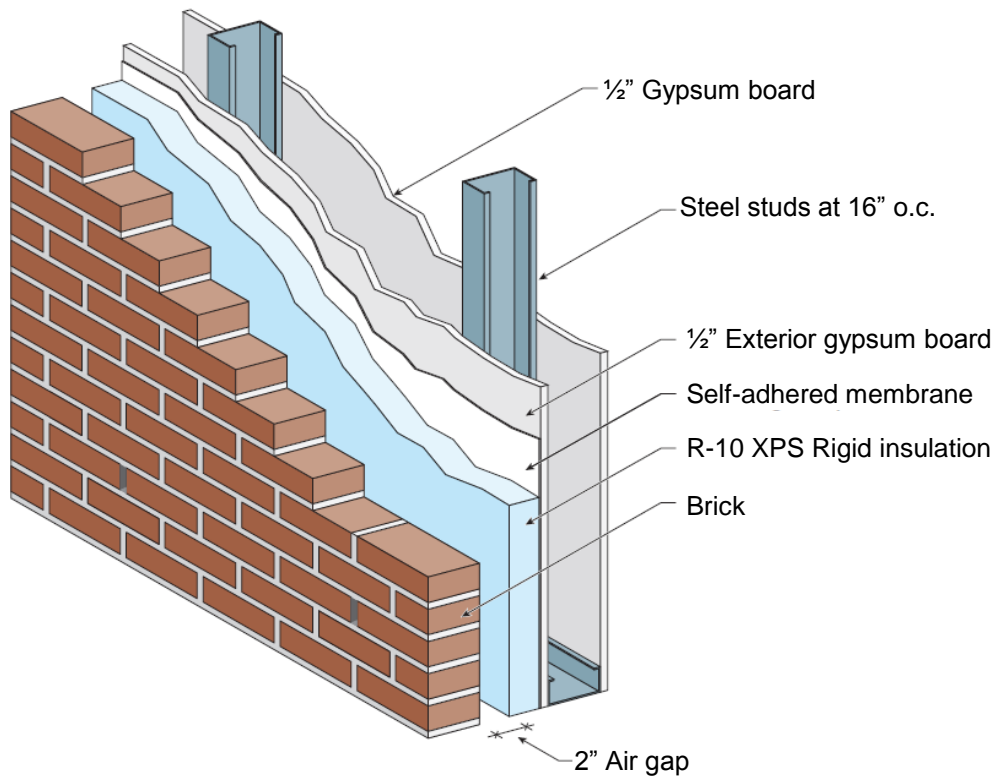

Figure 14. Material layout in panel P1-12.

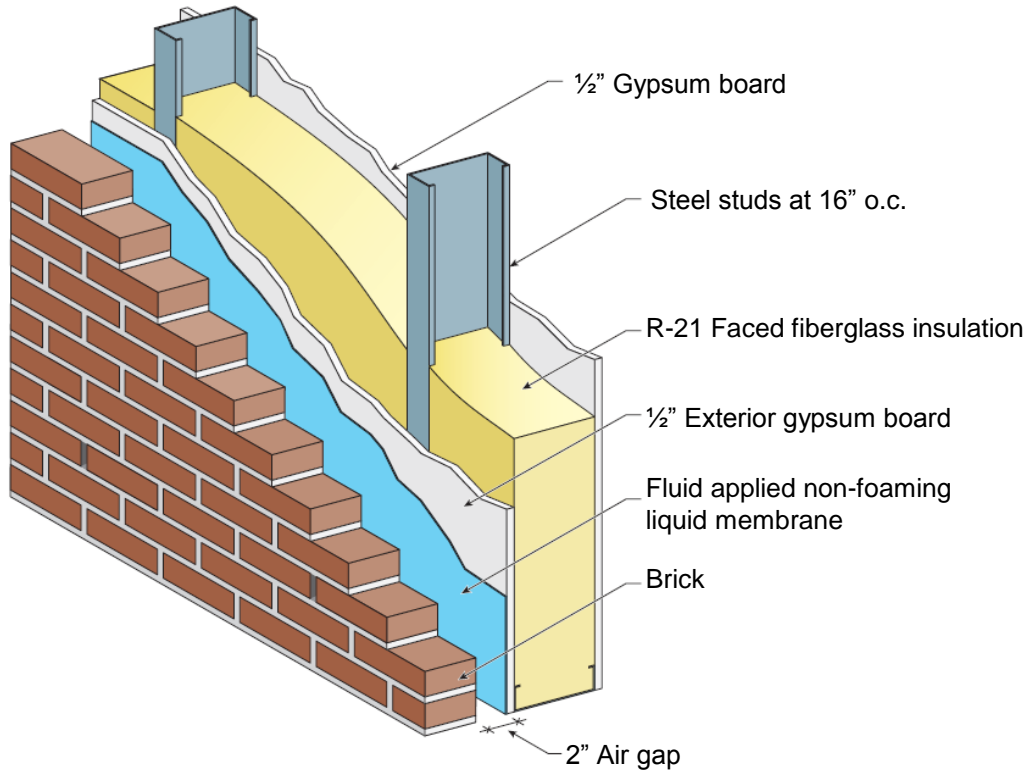

Figure 15. Material layout in panels P1-13 and P1-14.

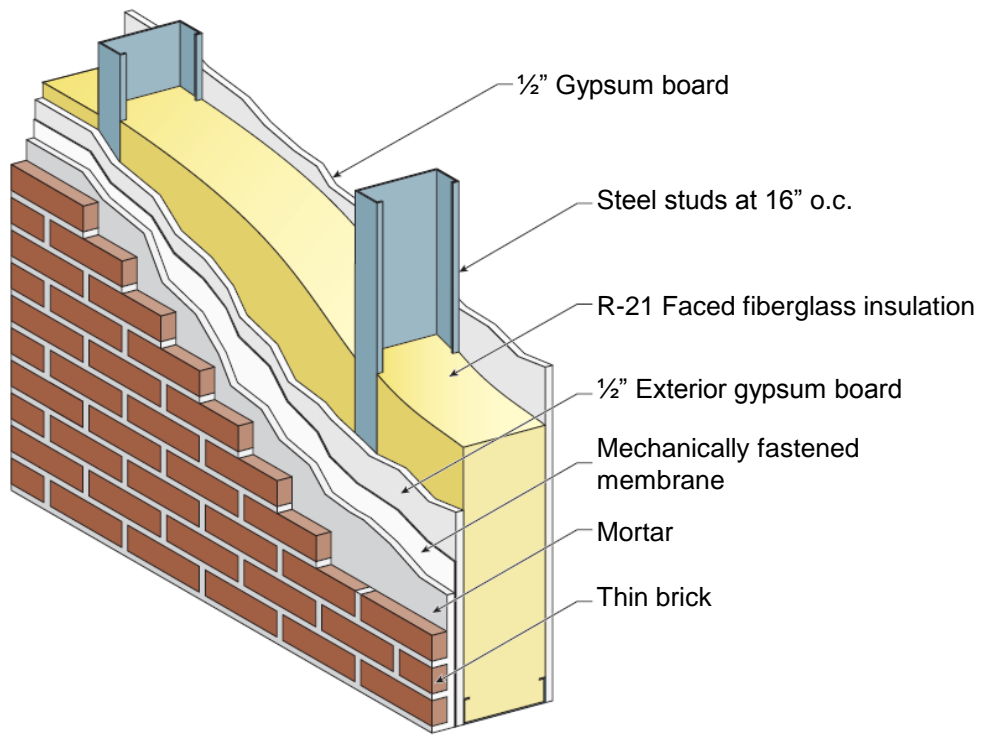

Figure 16. Material layout in panel P1-15.

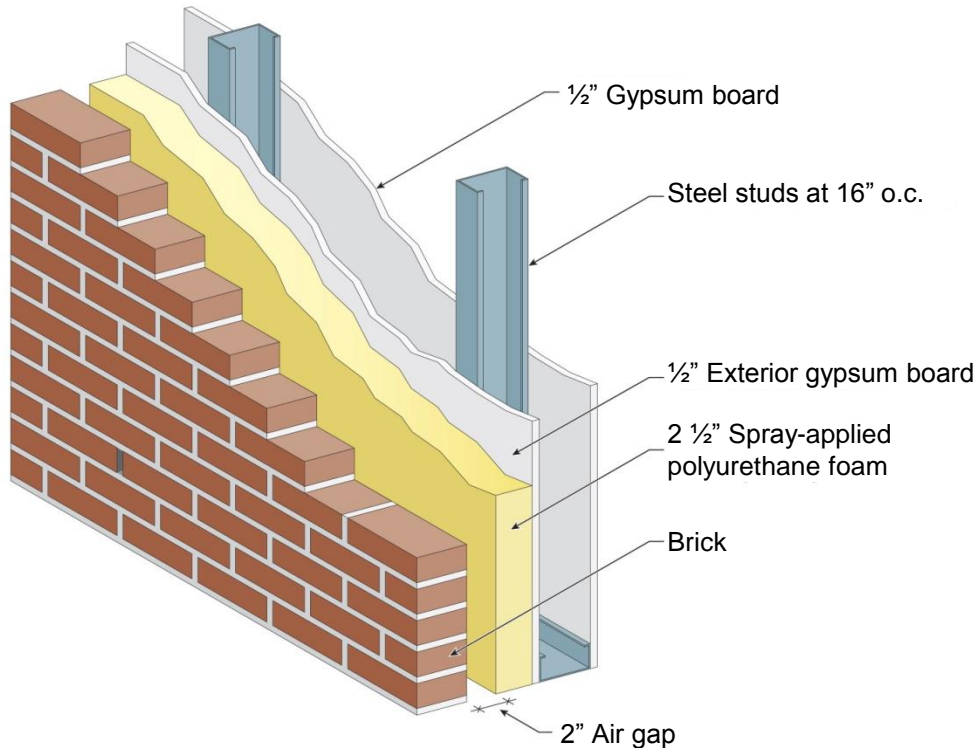

Figure 17. Material layout in panel P1-16.

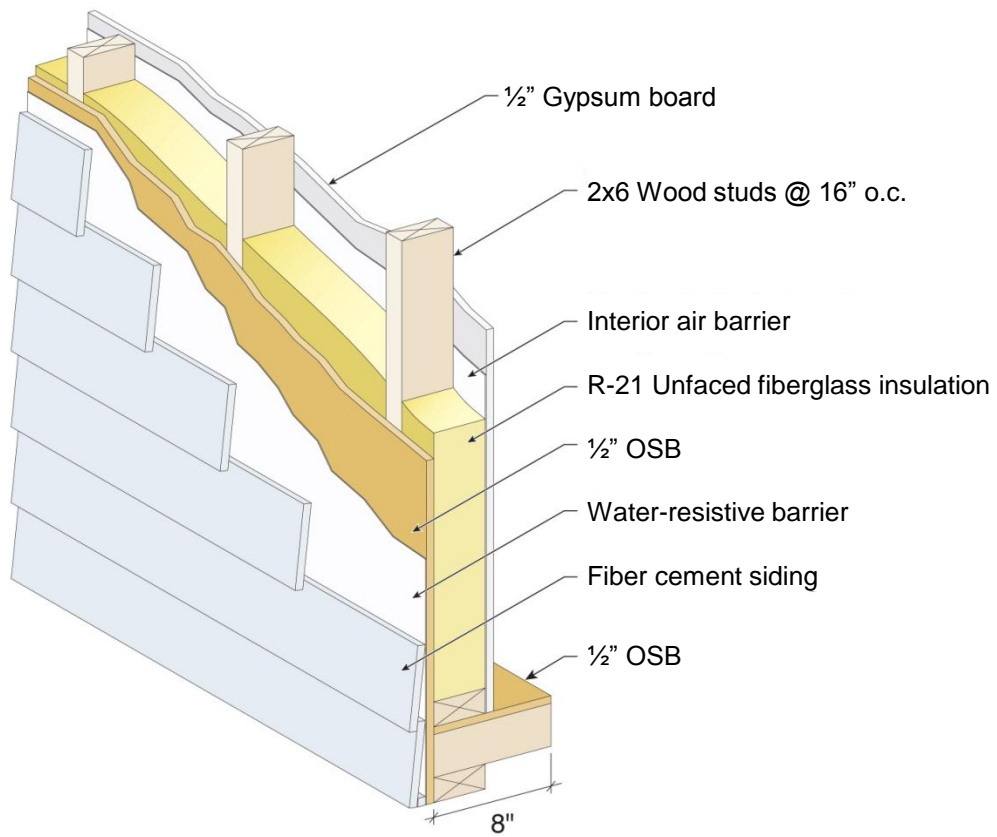

Figure 18. Material layout in panel P2-5.

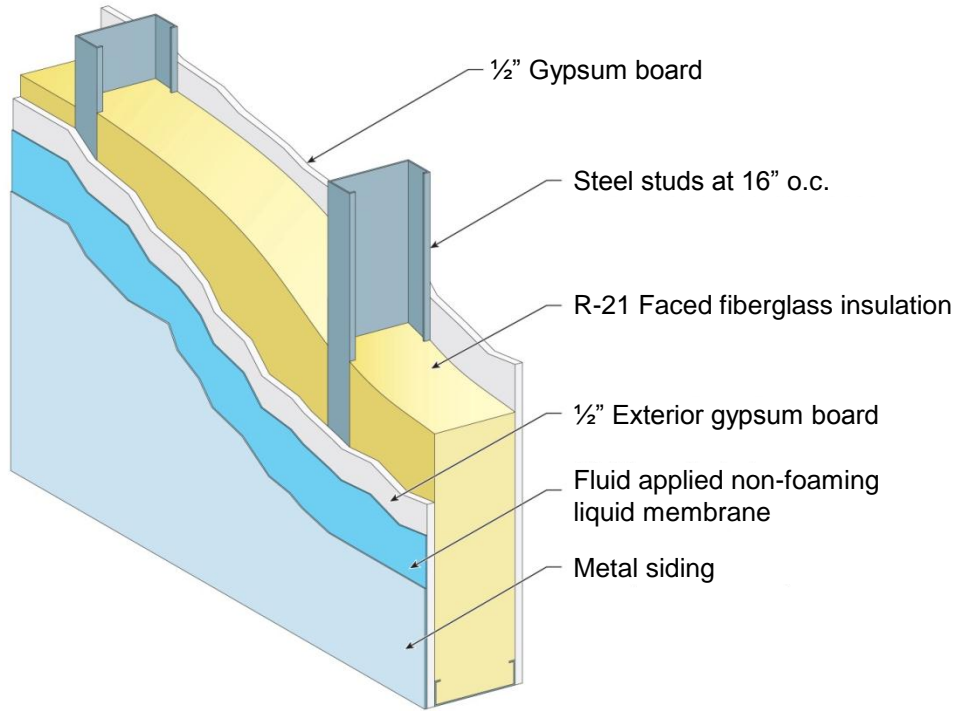

Figure 19. Material layout in panel P2-6.

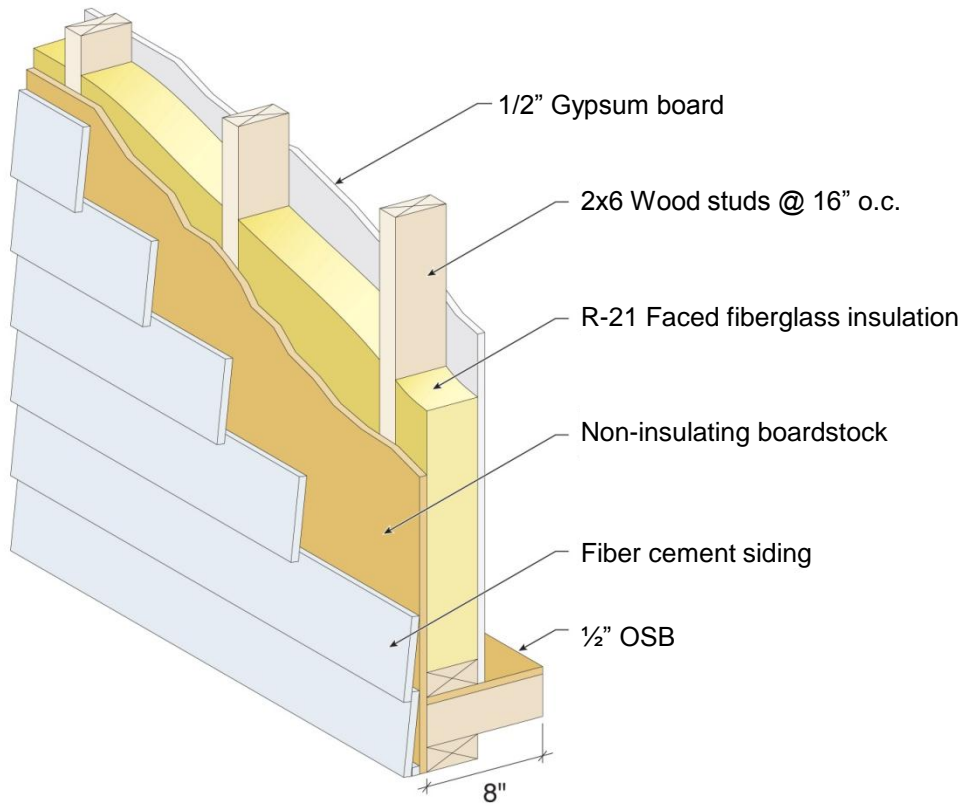

Figure 20. Material layout in panel P2-7.

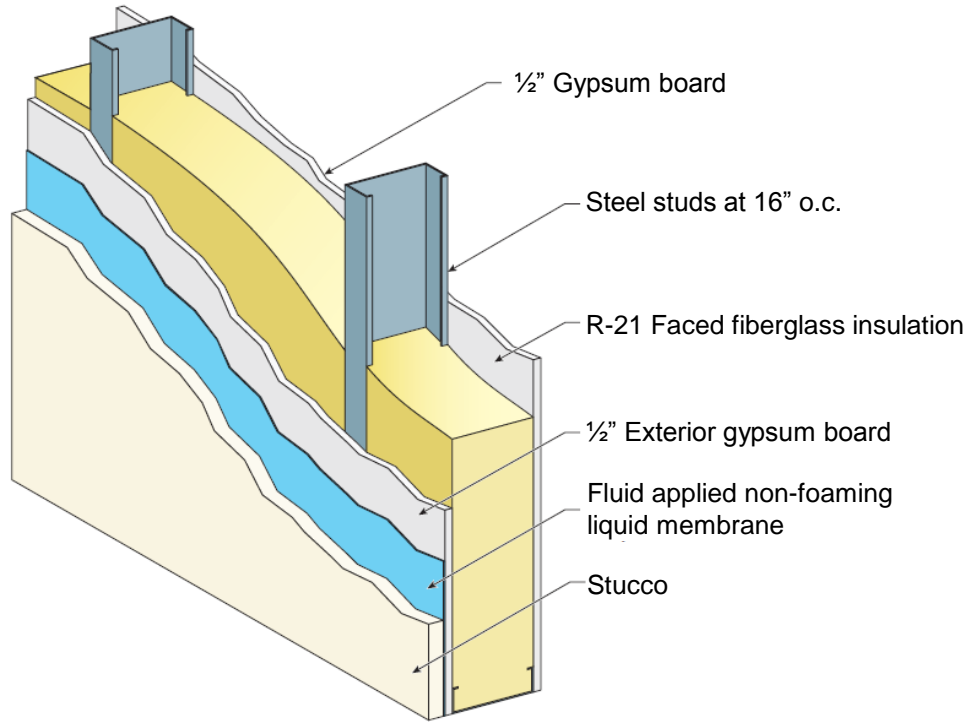

Figure 21. Material layout in panel P2-8.

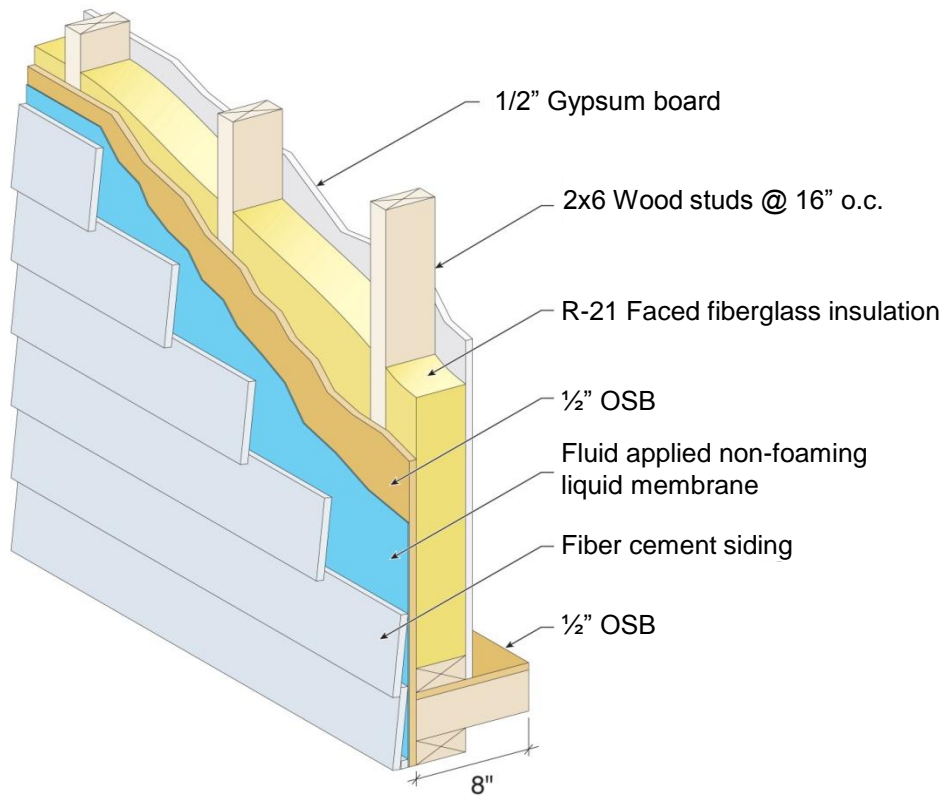

Figure 22. Material layout in panel P2-15.

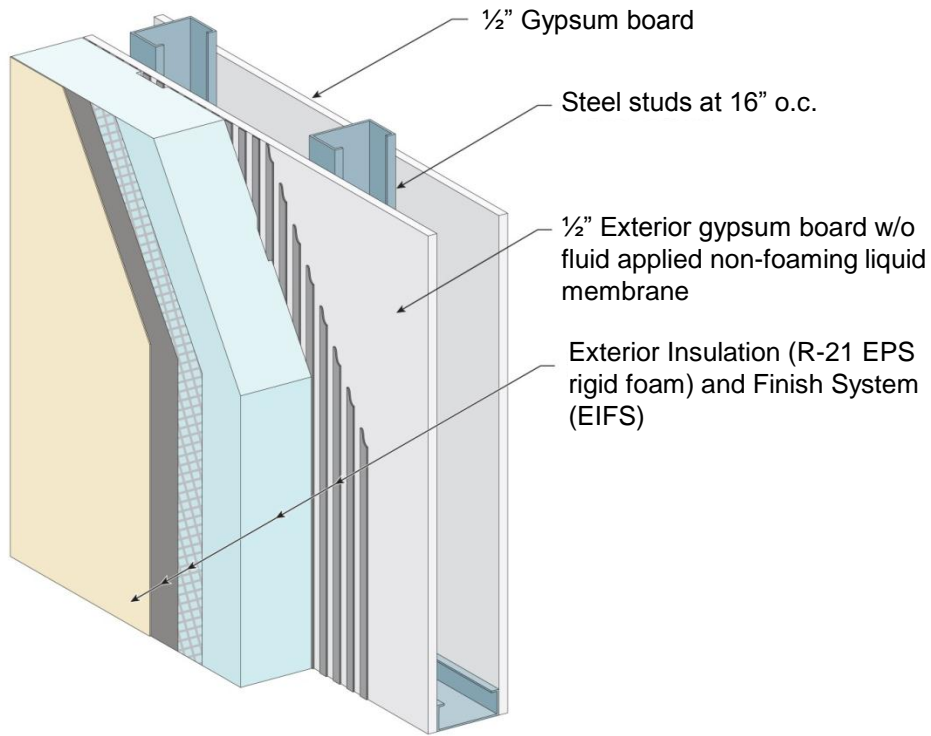

Figure 23. Material layout in panel P2-16 (control).

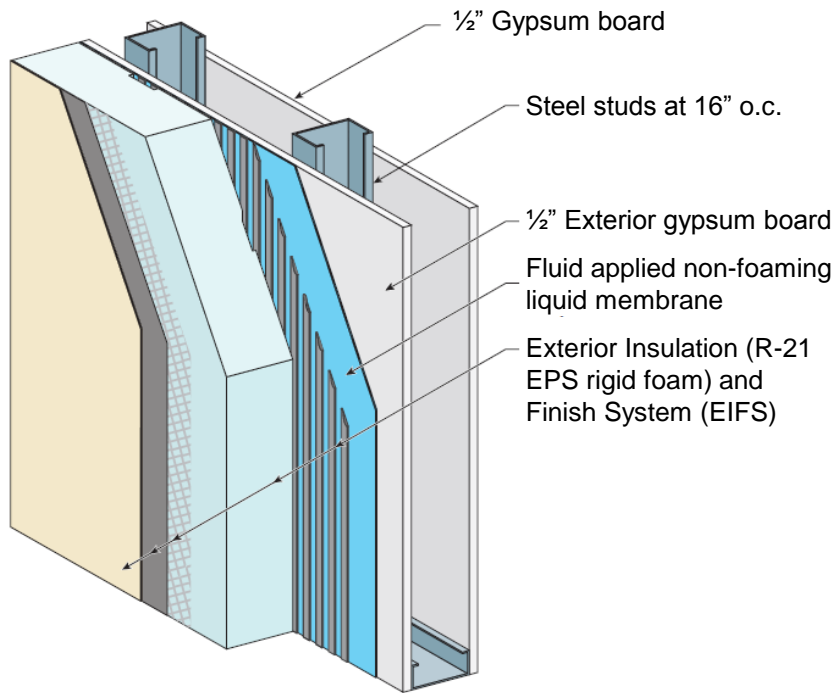

Figure 24. Material layout in panel P2-17.

The four layouts that were used with the temperature, relative humidity and heat flux sensors are illustrated in Figures 25 through 28. In these figures, “exterior” indicates that the instrument was on the outdoor side of the material, while “interior” implies that the sensor was on the indoor side of the member. The sensor layout used in each of the panels is described in Table 1.

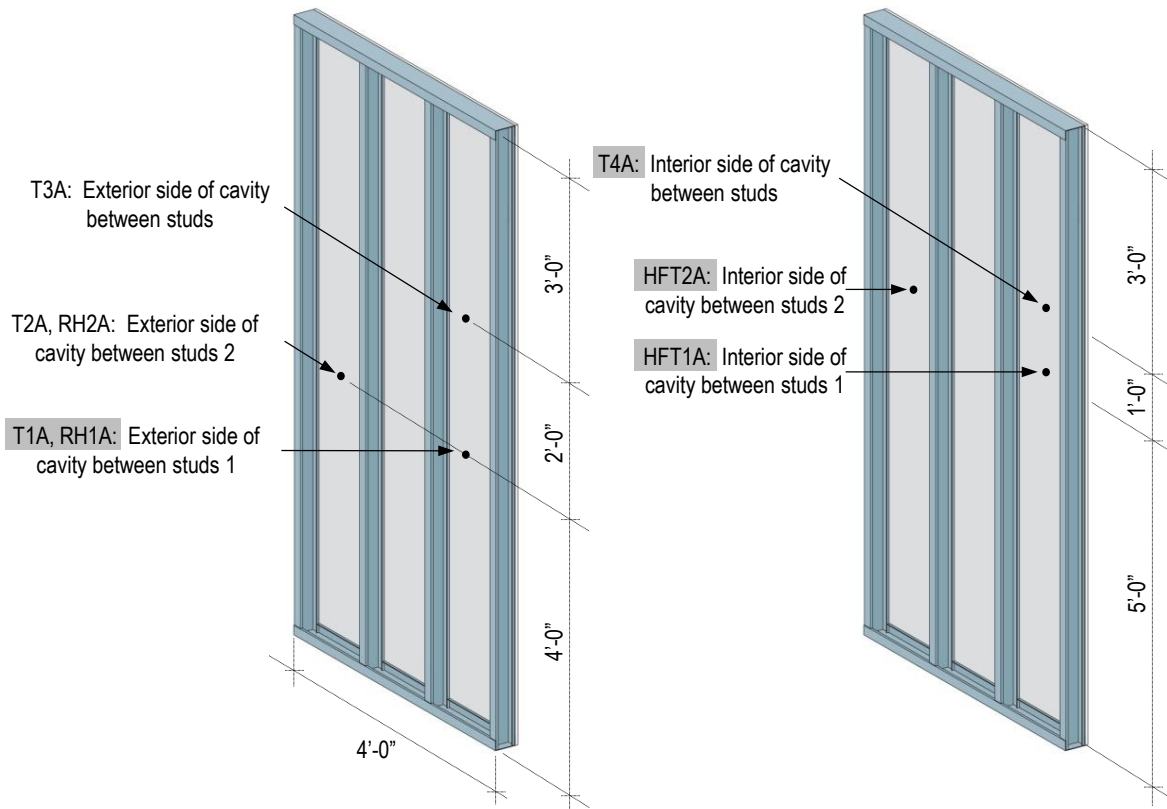

Figure 25. Sensor layout A.

Notes:

1. Data from sensors highlighted in gray are summarized in Tables 2 to 6 and are plotted in Appendixes A through D.
2. Sensor location
 - a. “Exterior” indicates that the sensor was on the outdoor side of the material.
 - b. “Interior” implies that the sensor was on the indoor side of the member.
3. Cavity insulation is not show for clarity.
4. Abbreviations: HFT: heat flux transducer; RH: relative humidity sensors; T: temperature sensors.

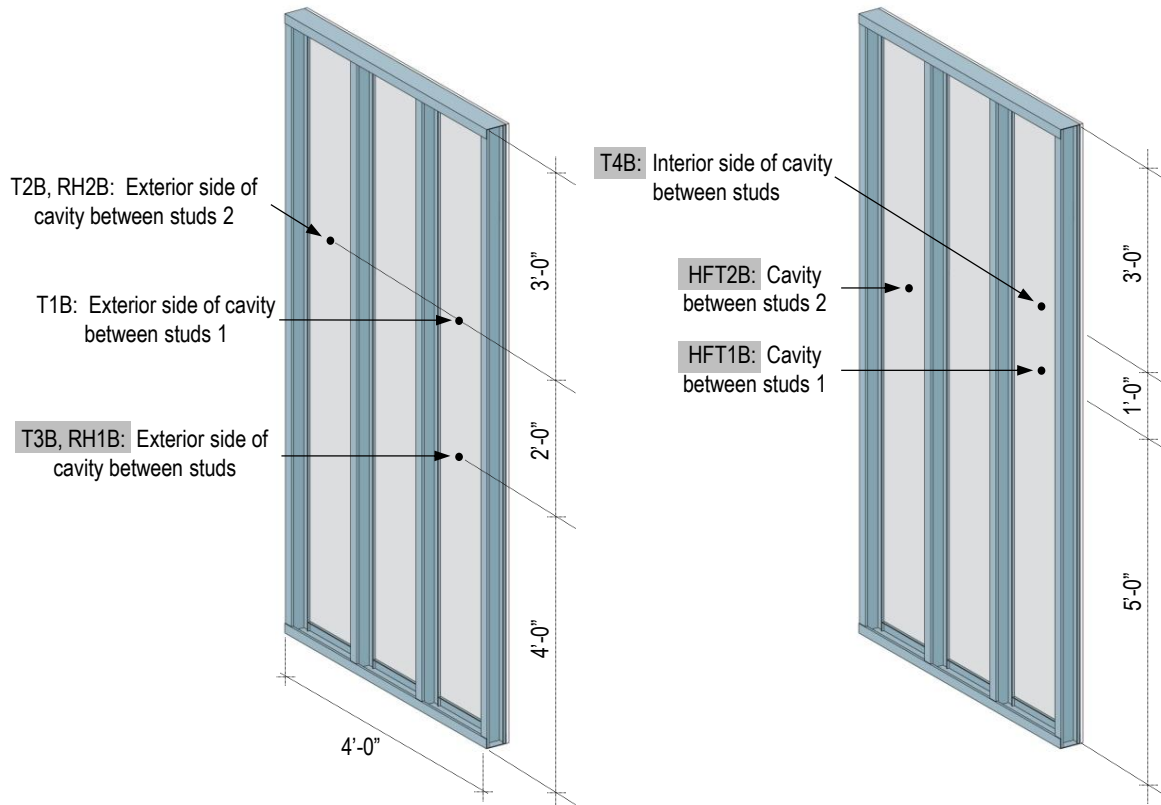

Figure 26. Sensor layout B.

Notes:

1. Data from sensors highlighted in gray are summarized in Tables 2 to 6 and are plotted in Appendixes A through D.
2. Sensor location
 - a. “Exterior” indicates that the sensor was on the outdoor side of the material.
 - b. “Interior” implies that the sensor was on the indoor side of the member.
3. Cavity insulation is not show for clarity.
4. Abbreviations: HFT: heat flux transducer; RH: relative humidity sensors; T: temperature sensors.

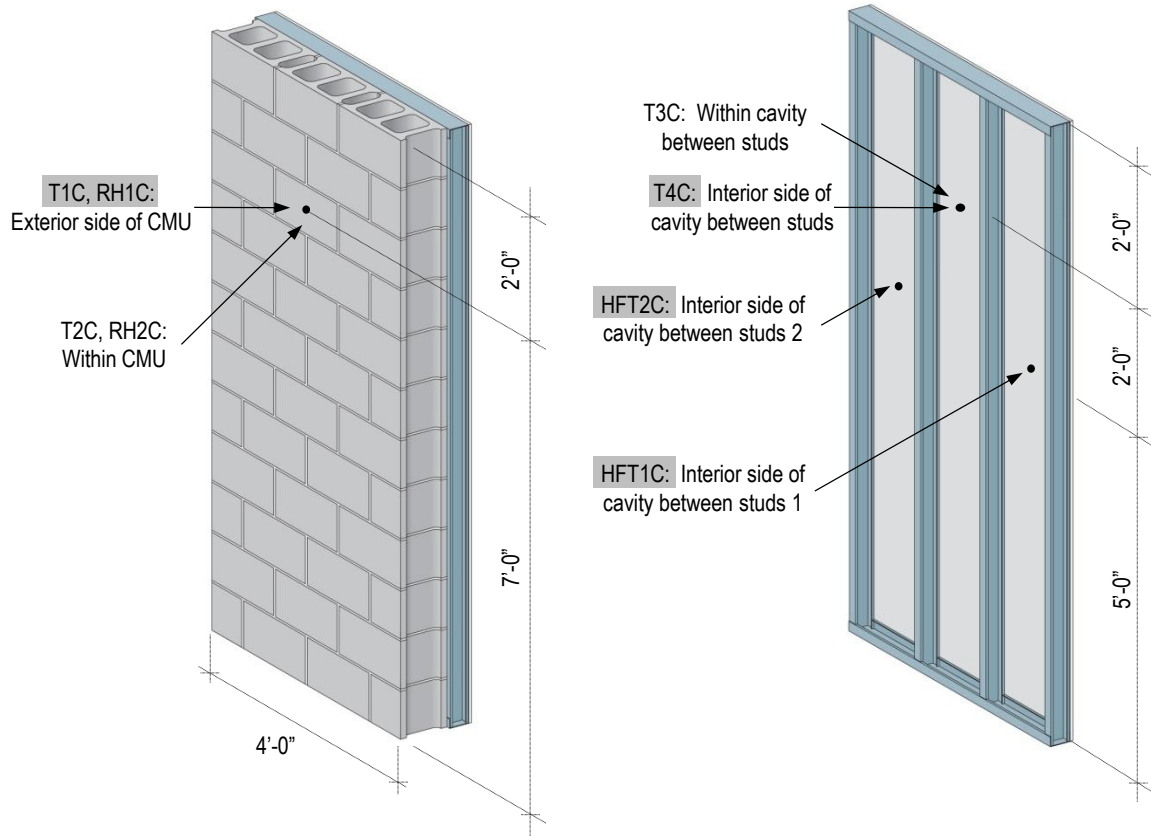

Figure 27. Sensor layout C.

Notes:

1. Data from sensors highlighted in gray are summarized in Tables 2 to 6 and are plotted in Appendixes A through D.
2. Sensor location
 - a. "Exterior" indicates that the sensor was on the outdoor side of the material.
 - b. "Interior" implies that the sensor was on the indoor side of the member.
 - c. Sensors within the CMU and stud cavity were located at mid-depth.
3. Abbreviations: HFT: heat flux transducer; RH: relative humidity sensors; T: temperature sensors.

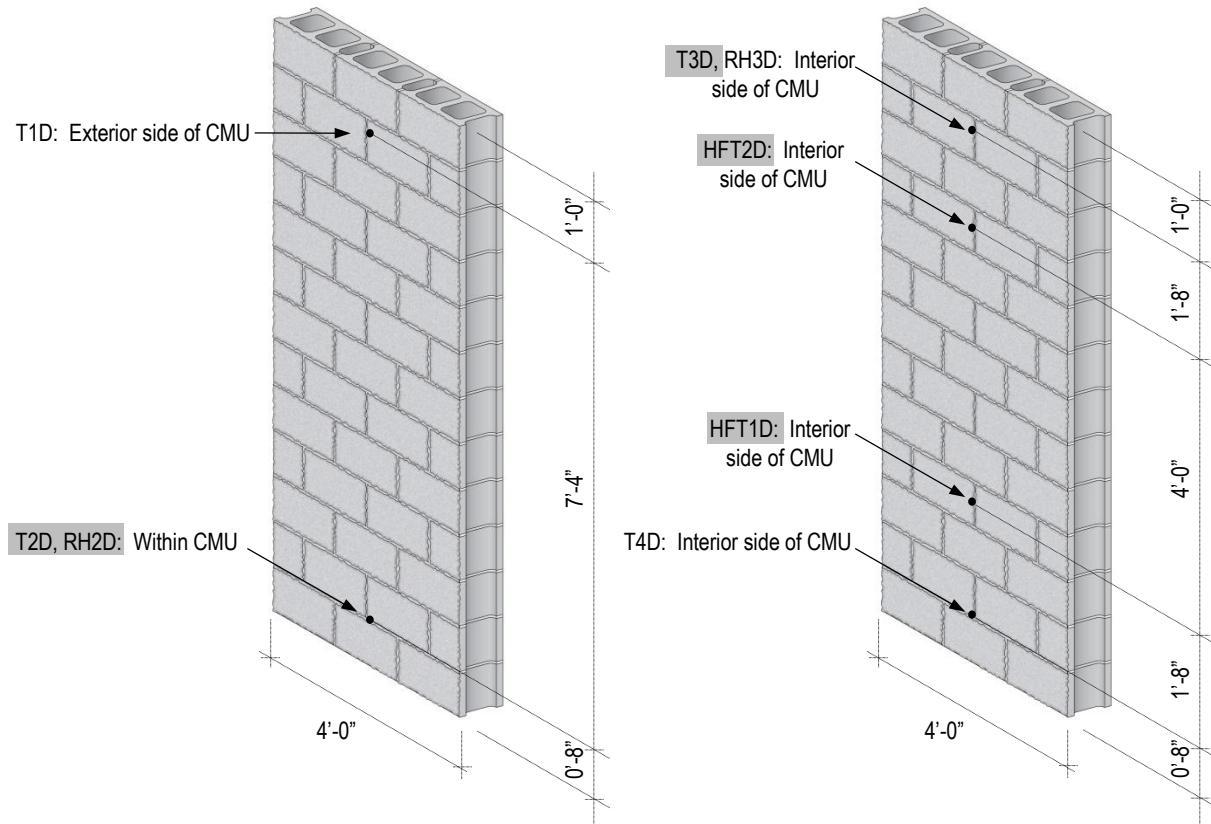

Figure 28. Sensor layout D

Notes:

1. Data from sensors highlighted in gray are summarized in Tables 2 to 6 and are plotted in Appendixes A through D.
2. Sensor location
 - a. "Exterior" indicates that the sensor was on the outdoor side of the material.
 - b. "Interior" implies that the sensor was on the indoor side of the member.
 - c. Sensors within the CMU and stud cavity were located at mid-depth.
 - d. Sensors shown as triangles were located on the interior side of the CMU.
3. Abbreviations: HFT: heat flux transducer; RH: relative humidity sensors; T: temperature sensors.

4. Experimental Procedures

Data from all sensors, except from pressure monitors, were scanned every minute and are reported as hourly averages. Pressure measurements were collected and are reported every minute. Temperature and relative humidity measurements collected indoors and from the specimens were utilized to estimate water vapor pressure based on equations from the 2005 ASHRAE Handbook – Fundamentals (ASHRAE 2005). Heat flux data from the two transducers were averaged and used to calculate cooling and heating loads.

5. Results

Monthly data from temperature, relative humidity and heat flux sensors that are highlighted in gray in Figures 25 through 28 were grouped based on panel orientation and are summarized in Tables 2 to 6. These tables also include indoor and outdoor measurements. Figures 29 through 36 show the monthly contribution to the cooling and heating loads from each of the panels. Additionally, Figures 37 and 38 indicate their respective annual contributions. Note that these heating and cooling load estimates were obtained from a section of the test panel; consequently, these are not representative of the heat transfer throughout the entire specimen. Monthly and hourly data for all of these variables are plotted in Appendixes A through D. Monthly total solar insolation on each side of the test hut is summarized in Table 7. Monthly average wind speeds are shown in Table 8. Rain accumulation per month is described in Table 9. Weekly and monthly differences in pressure between outdoors and indoors (reference) for each side of the building are shown in Table 10. Missing pressure measurements were due to equipment malfunction; more specifically, taps were clogged from the outside by insects. Pressure data and outdoor environmental measurements are plotted in Appendixes E to H. Spreadsheets with the aforementioned data will be available online.

Table 2. Continuation.

Month	Descriptive Statistics	In 1 st fl	In 2 nd fl	Out	North Panels					East Panels						South Panels						West Panels						
					P1-15	P1-16	P2-15	P2-16	P2-17	P1-10	P1-11	P1-12	P1-13	P1-14	P2-14	P1-6	P1-7	P1-8	P1-9	P2-6	P2-7	P2-8	P1-1	P1-2	P1-3	P1-4	P1-5	P2-5
					Layout A T1A	Layout A T1A	Layout A T1A	Layout B T3B	Layout B T3B	Layout C T1C	Layout C T1C	Layout A T1A	Layout A T1A	Layout A T1A	Layout A T1A	Layout A T1A	Layout A T1A	Layout B T3B	Layout B T3B	Layout A T1A	Layout B T3B	Layout A T1A	Layout C T1C	Layout D T2D	Layout B T3B	Layout A T1A	Layout A T1A	Layout B T3B
May 10	Mean	21.5	21.7	16.5	17.4	20.8	13.1	21.1	11.4	21.4	21.4	21.2	20.8	20.8	20.9	21.2	21.8	22.7	22.7	21.7	21.2	20.2	21.5	21.8	23.0	23.7	23.4	21.9
	SD	1.77	2.12	7.18	7.53	2.31	7.60	2.58	5.26	2.46	4.77	2.36	7.58	7.65	9.77	1.91	2.50	4.95	4.93	6.59	5.29	5.08	1.82	4.23	7.03	7.78	7.02	6.24
	5 th ptile	17.5	17.0	3.20	3.90	15.8	4.15	15.5	15.5	16.3	12.3	16.2	7.65	7.52	5.56	18.3	17.3	14.6	14.6	11.8	12.8	11.7	18.7	15.6	13.8	13.2	13.9	12.6
	Median	22.3	22.5	17.0	17.0	21.7	17.5	21.8	21.9	22.1	22.0	21.9	20.5	20.5	19.5	21.7	22.0	22.3	22.2	20.6	20.7	19.9	22.0	21.2	21.6	22.0	22.0	21.0
	95 th ptile	23.0	23.8	27.5	29.5	23.2	29.7	24.1	24.1	24.1	28.8	24.0	33.9	34.0	38.8	24.0	25.8	31.4	31.3	34.0	30.8	28.8	23.8	30.0	37.6	39.2	37.2	34.0
Jun 10	Mean	20.5	21.1	19.4	20.7	20.6	20.5	20.9	21.0	21.2	22.2	20.7	22.5	22.8	23.0	23.5	24.9	27.3	27.2	13.1	25.7	11.4	23.9	25.2	27.3	28.3	27.9	26.3
	SD	2.06	2.04	4.29	5.13	1.94	4.85	2.04	2.04	1.83	2.91	2.06	5.11	5.16	6.96	1.08	2.26	5.45	5.46	7.60	6.01	5.26	0.90	4.46	7.99	8.69	8.01	6.98
	5 th ptile	17.6	18.1	12.0	11.9	17.8	12.2	17.7	17.7	18.4	16.9	17.5	14.2	14.4	12.8	21.8	21.3	18.9	18.9	15.5	16.4	15.0	22.0	19.2	17.3	17.4	17.8	16.6
	Median	22.1	22.2	19.3	20.5	21.4	20.2	21.5	21.6	21.7	22.4	21.5	22.1	22.3	22.1	23.4	24.8	26.5	26.4	24.5	24.6	23.7	23.9	24.2	25.1	25.8	25.7	24.8
	95 th ptile	22.5	23.5	26.4	29.0	23.2	28.4	23.8	23.9	23.6	26.5	23.4	31.3	31.7	35.9	25.3	28.7	36.6	36.6	39.7	36.2	33.5	25.4	33.9	44.4	46.3	44.1	40.4
Jul 10	Mean	22.4	23.2	23.6	24.4	22.7	13.1	23.2	11.4	23.6	25.7	22.9	27.0	27.3	27.7	23.3	24.4	25.9	26.1	13.1	24.3	11.4	23.2	23.6	25.0	25.6	25.4	23.8
	SD	0.16	0.64	4.26	5.33	0.72	7.60	0.99	5.26	0.82	2.84	0.91	5.47	5.49	7.76	1.18	2.42	5.64	5.87	7.60	6.28	5.26	0.78	3.99	7.21	7.84	7.11	6.25
	5 th ptile	22.1	22.3	16.3	15.8	21.5	16.3	21.6	21.7	22.2	21.1	21.5	18.7	18.9	17.1	21.7	20.7	18.0	18.2	14.5	15.7	14.4	21.8	18.3	16.2	16.1	16.6	15.3
	Median	22.4	23.1	23.3	24.2	22.7	24.1	23.2	23.2	23.6	25.6	22.8	26.2	26.6	26.4	23.1	24.1	24.9	24.9	22.8	23.0	22.0	23.2	22.8	23.2	23.6	23.6	22.8
	95 th ptile	22.6	24.3	30.4	33.5	24.0	33.3	25.0	25.1	25.2	30.9	24.4	36.3	36.6	41.9	25.6	28.6	36.9	37.1	41.4	36.7	33.3	24.5	31.8	40.7	42.1	40.1	37.0
Aug 10	Mean	22.4	22.9	21.7	22.0	22.4	13.1	22.8	11.4	23.2	24.4	22.6	24.8	24.9	24.9	21.2	21.8	22.7	22.7	21.7	21.2	20.2	21.5	21.8	23.0	23.7	23.4	21.9
	SD	0.16	0.73	3.96	4.68	0.67	7.60	1.04	5.26	0.74	2.54	0.86	4.95	4.89	6.82	1.91	2.50	4.95	4.93	6.59	5.29	5.08	1.82	4.23	7.03	7.78	7.02	6.24
	5 th ptile	22.1	22.1	15.3	14.2	21.3	14.3	21.3	21.3	21.8	20.2	21.4	17.4	17.6	15.5	18.3	17.3	14.6	14.6	11.8	12.8	11.7	18.7	15.6	13.8	13.2	13.9	12.6
	Median	22.4	22.7	21.3	21.8	22.3	21.9	22.7	22.7	23.2	24.3	22.5	24.2	24.3	23.6	21.7	22.0	22.3	22.2	20.6	20.7	19.9	22.0	21.2	21.6	22.0	22.0	21.0
	95 th ptile	22.7	24.5	28.3	29.8	23.5	30.0	24.8	24.9	24.4	28.9	24.2	33.8	33.6	38.0	24.0	25.8	31.4	31.3	34.0	30.8	28.8	23.8	30.0	37.6	39.2	37.2	34.0

Notes: Layouts A, B, C and D refer to the location of the sensors per Figures 25 through 28.

Abbreviations: NA, not available; ptile, percentile; SD, standard deviation.

Table 3. Continuation.

Month	Descriptive Statistics	In 1 st fl	In 2 nd fl	Out	North Panels					East Panels						South Panels						West Panels						
					P1-15	P1-16	P2-15	P2-16	P2-17	P1-10	P1-11	P1-12	P1-13	P1-14	P2-14	P1-6	P1-7	P1-8	P1-9	P2-6	P2-7	P2-8	P1-1	P1-2	P1-3	P1-4	P1-5	P2-5
					Layout A T4A	Layout A T4A	Layout A T4A	Layout B T4B	Layout B T4B	Layout C T4C	Layout C T4C	Layout A T4A	Layout A T4A	Layout A T4A	Layout A T4A	Layout A T4A	Layout A T4A	Layout A T4A	Layout B T4B	Layout B T4B	Layout A T4A	Layout B T4C	Layout A T4A	Layout C T4C	Layout C T3D	Layout B T4B	Layout A T4A	Layout A T4A
May 10	Mean	21.5	21.7	16.5	20.9	20.9	20.4	21.2	20.2	21.4	21.5	21.3	21.4	21.4	21.6	21.7	21.6	21.5	21.4	20.4	21.4	20.2	21.4	21.5	21.3	21.4	21.6	21.3
	SD	1.77	2.12	7.18	2.26	2.13	1.16	2.43	0.89	1.98	2.61	2.12	1.98	2.03	2.47	2.26	2.04	2.13	2.17	1.16	2.54	0.89	2.09	3.86	2.17	2.21	2.12	2.67
	5 th ptile	17.5	17.0	3.20	16.1	16.2	16.3	16.0	15.7	17.0	16.0	16.7	17.0	17.0	16.3	16.8	17.1	16.7	16.7	15.8	16.1	15.7	17.0	14.2	16.7	16.8	17.1	15.8
	Median	22.3	22.5	17.0	21.6	21.8	22.1	22.0	21.9	22.4	22.4	22.1	22.2	22.2	22.2	22.4	22.4	22.3	22.2	22.0	22.1	21.8	22.5	21.6	22.1	22.0	22.4	22.0
	95 th ptile	23.0	23.8	27.5	23.5	23.0	23.8	23.9	24.2	23.1	24.5	23.6	23.3	23.5	24.4	24.2	23.6	23.7	23.8	25.1	24.5	24.6	23.2	28.2	23.9	24.5	24.2	24.8
Jun 10	Mean	20.5	21.1	19.4	20.5	20.5	20.9	21.0	21.1	20.8	21.2	20.6	20.5	20.7	21.2	21.1	21.0	20.8	20.8	21.2	21.1	21.0	21.0	21.8	20.8	20.8	21.0	21.1
	SD	2.06	2.04	4.29	2.01	1.96	2.01	2.01	2.01	1.90	1.99	2.06	2.11	2.05	2.06	1.87	1.83	1.90	1.93	2.18	2.05	2.11	1.90	2.92	1.99	1.99	1.96	2.11
	5 th ptile	17.6	18.1	12.0	17.4	17.8	17.7	17.8	17.8	18.2	17.9	17.6	17.5	17.7	17.8	18.3	18.3	18.0	17.9	17.6	17.8	17.6	18.4	17.3	17.8	17.8	18.0	17.7
	Median	22.1	22.2	19.3	21.4	21.6	21.7	21.7	21.6	22.0	21.9	21.8	21.9	21.9	21.9	22.0	22.1	21.9	21.8	21.6	21.7	21.5	22.1	21.6	21.7	21.8	22.0	21.7
	95 th ptile	22.5	23.5	26.4	23.2	22.9	23.4	23.7	24.0	22.8	23.8	23.1	22.9	23.1	24.1	23.5	23.1	23.1	23.1	24.5	24.0	24.1	23.0	27.1	23.4	23.5	23.5	24.2
Jul 10	Mean	22.4	23.2	23.6	22.6	22.6	20.4	23.2	20.2	22.8	22.7	22.7	22.5	22.8	23.6	23.3	22.9	22.8	22.8	20.4	23.5	20.2	23.1	24.6	23.0	23.0	23.1	23.5
	SD	0.16	0.64	4.26	0.81	0.55	1.16	0.91	0.89	0.38	0.37	0.70	0.50	0.69	1.04	0.79	0.51	0.58	0.64	1.16	1.09	0.89	0.43	2.91	0.79	1.13	0.83	1.26
	5 th ptile	22.1	22.3	16.3	21.4	21.7	21.8	21.8	21.7	22.2	22.1	21.8	21.8	21.9	22.0	22.1	22.1	21.9	21.9	21.6	21.8	21.4	22.2	20.9	21.9	21.8	22.1	21.8
	Median	22.4	23.1	23.3	22.5	22.5	23.0	23.2	23.3	22.8	22.6	22.6	22.4	22.6	23.5	23.2	22.9	22.7	22.8	23.5	23.4	23.3	23.1	23.8	22.8	22.6	22.8	23.4
	95 th ptile	22.6	24.3	30.4	24.2	23.6	24.6	24.9	25.3	23.6	23.4	24.0	23.4	24.1	25.4	24.6	23.8	23.8	24.0	26.2	25.4	25.7	23.8	30.5	24.5	25.5	24.7	25.9
Aug 10	Mean	22.4	22.9	21.7	22.3	22.3	20.4	22.9	20.2	22.7	22.6	22.6	22.4	22.5	23.1	23.1	22.8	22.7	22.8	20.4	23.1	20.2	22.8	23.7	22.7	22.8	22.9	23.1
	SD	0.16	0.73	3.96	0.67	0.52	1.16	1.00	0.89	0.35	0.31	0.64	0.47	0.57	1.14	0.85	0.53	0.58	0.69	1.16	1.18	0.89	0.41	2.67	0.73	1.00	0.66	1.26
	5 th ptile	22.1	22.1	15.3	21.3	21.5	21.5	21.6	21.4	22.1	22.1	21.7	21.8	21.8	21.6	22.0	22.1	21.9	21.9	21.3	21.6	21.2	22.1	20.5	21.8	21.7	22.1	21.4
	Median	22.4	22.7	21.3	22.2	22.2	22.6	22.7	22.8	22.7	22.6	22.5	22.3	22.4	23.0	23.0	22.8	22.6	22.6	22.9	22.9	22.8	22.8	23.0	22.6	22.5	22.7	22.8
	95 th ptile	22.7	24.5	28.3	23.5	23.3	24.7	24.8	25.2	23.3	23.1	23.8	23.3	23.5	25.4	24.8	23.8	23.8	24.1	26.5	25.5	25.7	23.6	29.3	24.3	24.9	24.3	25.6

Notes: Layouts A, B, C and D refer to the location of the sensors per Figures 25 through 28.

Abbreviations: NA, not available; ptile, percentile; SD, standard deviation.

Table 4. Continuation.

Month	Descriptive Statistics	In 1st fl	In 2nd fl	Out	North Panels					East Panels						South Panels						West Panels						
					P1-15	P1-16	P2-15	P2-16	P2-17	P1-10	P1-11	P1-12	P1-13	P1-14	P2-14	P1-6	P1-7	P1-8	P1-9	P2-6	P2-7	P2-8	P1-1	P1-2	P1-3	P1-4	P1-5	P2-5
					Layout A RH1A	Layout A RH1A	Layout A RH1A	Layout B RH1B	Layout B RH1B	Layout C RH1C	Layout C RH1C	Layout A RH1A	Layout A RH1A	Layout A RH1A	Layout A RH1A	Layout A RH1A	Layout A RH1A	Layout B RH1B	Layout B RH1B	Layout A RH1A	Layout B RH1B	Layout A RH1A	Layout C RH1C	Layout C RH2D	Layout B RH1B	Layout A RH1A	Layout A RH1A	Layout B RH1B
May 10	Mean	36.4	36.1	61.6	57.7	40.1	NA	38.7	89.7	41.8	39.2	35.8	45.7	45.8	39.6	36.3	40.6	43.1	39.4	77.2	46.3	89.7	50.3	78.0	37.2	57.0	45.8	47.3
	SD	4.25	3.60	17.8	10.7	6.10	NA	3.78	3.78	1.45	3.26	2.79	11.3	10.6	5.21	2.52	3.87	12.1	9.84	13.0	4.64	3.78	4.37	10.1	1.84	9.43	15.0	5.07
	5 th ptile	31.0	31.4	33.2	40.9	30.5	NA	34.0	36.0	39.6	34.0	30.6	28.8	29.4	30.3	31.7	36.6	24.7	23.7	22.0	37.4	38.4	42.1	57.8	34.1	39.2	23.1	38.2
	Median	35.1	35.2	60.7	58.3	39.6	NA	37.4	40.3	41.5	39.1	35.3	44.2	44.7	40.0	36.1	39.6	43.0	39.6	42.7	47.1	57.2	52.3	80.1	37.2	58.2	44.6	47.6
	95 th ptile	44.3	43.0	94.2	75.8	50.8	NA	45.4	48.1	44.4	44.7	41.2	67.7	66.8	48.0	41.3	48.4	64.3	57.7	70.3	53.4	73.4	56.0	90.8	39.8	69.2	72.1	55.7
Jun 10	Mean	46.8	48.9	72.7	59.3	52.9	NA	50.7	54.2	48.7	47.4	47.7	50.3	49.2	42.1	48.4	54.9	57.3	50.2	48.6	47.0	56.8	59.2	86.0	40.1	50.0	46.9	46.4
	SD	3.80	4.78	16.1	9.02	6.08	NA	4.66	4.10	2.33	4.32	3.83	9.3	8.58	4.88	4.62	6.37	12.9	10.2	11.7	3.95	7.37	2.47	7.05	2.73	8.13	12.2	4.59
	5 th ptile	41.2	41.6	43.1	43.0	38.6	NA	41.1	47.6	45.2	38.7	42.5	33.9	33.1	34.6	42.4	44.6	35.3	32.2	30.6	40.0	44.8	56.1	67.3	35.1	35.9	27.1	38.5
	Median	46.8	48.8	74.8	60.3	54.9	NA	52.0	54.1	48.0	48.3	46.7	49.9	48.9	42.0	47.8	54.4	58.5	51.1	48.0	47.0	56.2	58.6	87.5	40.2	50.1	46.6	46.3
	95 th ptile	52.9	57.0	95.3	73.1	59.2	NA	56.1	60.1	53.4	53.1	54.9	64.8	62.5	50.3	56.4	66.0	76.8	65.0	70.1	53.0	69.2	63.4	93.9	45.1	62.3	66.8	53.8
Jul 10	Mean	45.4	52.5	66.4	52.7	55.2	NA	53.5	89.7	53.9	55.4	51.2	45.8	45.7	41.0	51.8	55.4	52.0	46.1	77.2	47.0	89.7	61.7	88.5	39.3	52.1	42.0	46.0
	SD	2.78	3.31	15.4	9.64	5.16	NA	4.50	3.78	1.39	3.67	2.73	9.58	9.00	6.05	2.91	6.65	14.6	11.4	13.0	5.01	3.78	2.19	4.4	3.65	10.6	11.7	5.51
	5 th ptile	40.4	46.3	41.6	36.8	44.2	NA	45.3	52.2	51.6	50.3	46.1	30.0	30.8	30.6	46.7	44.5	30.2	28.4	24.7	38.4	37.5	58.4	79.1	34.0	33.3	21.3	36.5
	Median	45.5	52.5	66.0	52.5	56.3	NA	53.5	58.1	53.8	55.2	51.5	45.2	45.4	41.0	51.8	55.2	51.0	45.9	42.4	47.4	51.0	61.6	89.3	38.8	53.0	42.5	45.7
	95 th ptile	49.6	57.8	92.5	68.6	62.4	NA	61.5	61.8	56.1	62.0	55.5	62.5	60.5	51.5	56.5	66.3	82.1	67.5	64.4	56.0	71.1	65.8	94.2	45.6	70.5	62.3	55.5
Aug 10	Mean	58.7	57.6	70.6	65.5	59.0	NA	59.3	89.7	58.3	61.7	56.0	56.1	54.6	48.2	55.4	57.2	54.9	48.7	77.2	49.8	89.7	64.0	90.1	43.6	58.1	51.7	51.0
	SD	4.69	4.43	15.7	13.7	4.52	NA	6.09	3.78	1.85	4.85	3.00	11.09	9.74	5.61	3.26	6.34	14.0	12.1	13.0	5.30	3.78	2.00	4.07	3.15	10.7	14.9	5.93
	5 th ptile	51.2	50.5	44.9	43.3	51.0	NA	48.9	56.4	55.0	53.7	50.8	39.3	38.9	39.2	49.6	46.1	32.1	28.4	26.4	40.3	45.6	60.2	82.2	39.4	38.7	28.4	40.9
	Median	58.2	57.8	71.0	64.7	59.3	NA	57.5	63.0	59.0	61.0	56.0	54.9	54.5	47.9	55.5	57.0	55.2	49.5	48.5	50.6	57.7	63.6	90.2	43.0	58.0	51.0	51.1
	95 th ptile	69.1	66.3	96.0	86.9	65.4	NA	67.9	67.0	60.5	71.7	61.5	77.0	71.4	57.4	60.1	67.3	77.4	68.8	68.1	58.5	72.8	67.2	96.2	49.7	76.4	79.1	60.9

Notes: Layouts A, B, C and D refer to the location of the sensors per Figures 25 through 28.

Abbreviations: NA, not available; ptile, percentile; SD, standard deviation.

Table 5. Continuation.

Month	Descriptive Statistics	In 1 st fl	In 2 nd fl	Out	North Panels					East Panels						South Panels						West Panels						
					P1-15	P1-16	P2-15	P2-16	P2-17	P1-10	P1-11	P1-12	P1-13	P1-14	P2-14	P1-6	P1-7	P1-8	P1-9	P2-6	P2-7	P2-8	P1-1	P1-2	P1-3	P1-4	P1-5	P2-5
					Layout A T1A/RH1A	Layout A T1A/RH1A	Layout A T1A/RH1A	Layout B T3B/RH1B	Layout B T3B/RH1B	Layout C T1C/RH1C	Layout C T1C/RH1C	Layout A T1A/RH1A	Layout A T1A/RH1A	Layout A T1A/RH1A	Layout A T1A/RH1A	Layout A T1A/RH1A	Layout A T1A/RH1A	Layout A T1A/RH1A	Layout A T1A/RH1A	Layout B T3B/RH1B	Layout B T3B/RH1B	Layout A T1A/RH1A	Layout B T3B/RH1B	Layout A T1A/RH1A	Layout C T1C/RH1C	Layout C T2D/RH2D	Layout B T3B/RH1B	Layout A T1A/RH1A
May 10	Mean	0.94	0.95	1.17	1.17	1.00	NA	0.97	1.04	1.08	1.02	0.91	1.11	1.12	1.07	0.94	1.07	1.10	1.00	0.96	1.10	1.18	1.30	1.93	1.01	1.50	1.11	1.13
	SD	0.17	0.18	0.43	0.39	0.25	NA	0.19	0.20	0.17	0.25	0.16	0.29	0.28	0.57	0.17	0.28	0.30	0.27	0.33	0.46	0.42	0.27	0.66	0.61	0.72	0.42	0.53
	5 th ptile	0.63	0.64	0.52	0.58	0.55	NA	0.65	0.68	0.76	0.62	0.63	0.68	0.66	0.43	0.64	0.63	0.63	0.59	0.57	0.47	0.58	0.84	1.07	0.38	0.58	0.61	0.45
	Median	0.95	0.96	1.11	1.13	1.02	NA	0.98	1.04	1.08	1.01	0.91	1.06	1.09	0.89	0.96	1.04	1.10	0.98	0.84	1.01	1.09	1.33	1.76	0.81	1.35	0.99	1.00
	95 th ptile	1.20	1.21	1.87	1.88	1.41	NA	1.30	1.39	1.30	1.48	1.15	1.69	1.65	2.33	1.20	1.57	1.68	1.49	1.67	2.03	2.01	1.64	3.39	2.41	3.02	2.02	2.24
Jun 10	Mean	1.14	1.23	1.65	1.46	1.30	NA	1.27	1.36	1.23	1.28	1.17	1.37	1.36	1.24	1.23	1.45	1.58	1.38	1.26	1.21	1.36	1.53	2.30	1.22	1.50	1.35	1.26
	SD	0.15	0.22	0.43	0.35	0.23	NA	0.22	0.22	0.16	0.22	0.20	0.31	0.29	0.49	0.22	0.28	0.39	0.31	0.36	0.33	0.34	0.20	0.58	0.58	0.53	0.45	0.41
	5 th ptile	0.91	0.91	0.93	0.96	0.89	NA	0.91	1.02	1.01	0.95	0.91	0.96	0.97	0.71	0.94	1.04	1.05	0.93	0.82	0.76	0.90	1.27	1.56	0.67	0.88	0.79	0.77
	Median	1.16	1.22	1.64	1.43	1.28	NA	1.25	1.33	1.25	1.25	1.17	1.31	1.31	1.12	1.22	1.43	1.49	1.33	1.17	1.15	1.30	1.57	2.19	1.03	1.37	1.27	1.16
	95 th ptile	1.37	1.59	2.33	2.09	1.64	NA	1.61	1.73	1.50	1.67	1.49	1.96	1.89	2.32	1.58	1.94	2.25	1.92	2.00	1.83	1.99	1.83	3.47	2.39	2.59	2.26	2.12
Jul 10	Mean	1.23	1.49	1.93	1.61	1.54	NA	1.53	1.65	1.57	1.85	1.43	1.61	1.64	1.58	1.51	1.75	1.84	1.64	1.42	1.59	1.58	1.82	2.90	1.55	2.03	1.55	1.62
	SD	0.08	0.11	0.45	0.31	0.17	NA	0.15	0.11	0.06	0.29	0.07	0.30	0.27	0.60	0.09	0.23	0.37	0.29	0.38	0.42	0.38	0.09	0.67	0.81	0.68	0.45	0.53
	5 th ptile	1.09	1.31	1.16	1.07	1.14	NA	1.22	1.44	1.45	1.38	1.29	1.20	1.23	0.91	1.35	1.38	1.25	1.17	0.96	1.02	1.07	1.61	2.05	0.84	1.27	0.95	1.02
	Median	1.23	1.50	1.93	1.58	1.57	NA	1.55	1.66	1.57	1.83	1.43	1.56	1.60	1.40	1.51	1.75	1.77	1.61	1.30	1.47	1.49	1.84	2.73	1.25	1.88	1.44	1.45
	95 th ptile	1.34	1.64	2.64	2.15	1.73	NA	1.75	1.82	1.66	2.35	1.55	2.14	2.11	2.93	1.64	2.16	2.55	2.15	2.13	2.38	2.29	1.95	4.28	3.49	3.51	2.39	2.79
Aug 10	Mean	1.59	1.61	1.82	1.69	1.59	NA	1.64	1.74	1.66	1.90	1.54	1.75	1.70	1.57	1.59	1.74	1.78	1.61	1.48	1.54	1.63	1.82	2.67	1.48	1.93	1.64	1.54
	SD	0.13	0.15	0.36	0.34	0.14	NA	0.16	0.12	0.07	0.32	0.09	0.33	0.27	0.57	0.10	0.21	0.32	0.28	0.42	0.44	0.42	0.08	0.59	0.73	0.62	0.45	0.47
	5 th ptile	1.38	1.41	1.21	1.24	1.33	NA	1.38	1.58	1.55	1.43	1.39	1.31	1.31	0.98	1.43	1.42	1.22	1.15	0.99	1.02	1.12	1.70	1.98	0.87	1.31	1.04	1.03
	Median	1.57	1.58	1.81	1.64	1.60	NA	1.63	1.72	1.67	1.87	1.53	1.67	1.66	1.39	1.58	1.73	1.79	1.59	1.34	1.40	1.51	1.81	2.50	1.22	1.73	1.55	1.40
	95 th ptile	1.88	1.94	2.43	2.42	1.83	NA	1.92	1.99	1.75	2.47	1.69	2.39	2.22	2.80	1.78	2.07	2.29	2.09	2.32	2.49	2.47	1.97	3.93	3.10	3.27	2.53	2.54

Notes: Layouts A, B, C and D refer to the location of the sensors per Figures 25 through 28.

Abbreviations: NA, not available; ptile, percentile; SD, standard deviation.

Table 6. Continuation.

Month	Descriptive Statistics	North Panels					East Panels						South Panels						West Panels						
		P1-15	P1-16	P2-15	P2-16	P2-17	P1-10	P1-11	P1-12	P1-13	P1-14	P2-14	P1-6	P1-7	P1-8	P1-9	P2-6	P2-7	P2-8	P1-1	P1-2	P1-3	P1-4	P1-5	P2-5
		Layout A	Layout A	Layout A	Layout B	Layout B	Layout C	Layout C	Layout A	Layout A	Layout A	Layout A	Layout A	Layout A	Layout B	Layout B	Layout A	Layout B	Layout A	Layout C	Layout C	Layout B	Layout A	Layout A	Layout B
May 10	Mean	-0.85	-0.98	-0.88	-1.28	-1.28	-0.38	-0.6	-0.24	-0.11	-0.06	-0.10	0.21	0.04	0.07	0.04	-0.35	-0.48	-0.86	-0.11	-0.7	-0.25	-0.17	-0.16	-0.55
	SD	1.55	1.62	1.32	1.27	1.25	1.59	4.47	2.39	1.48	1.42	1.97	2.44	1.20	1.53	1.51	2.03	1.51	1.41	1.72	18.2	2.24	2.62	1.92	1.94
	5 th ptile	-3.23	-3.77	-2.82	-3.32	-3.39	-2.71	-7.6	-3.66	-2.36	-2.14	-2.53	-3.27	-1.85	-2.26	-2.30	-2.84	-2.50	-2.88	-2.94	-26.4	-3.35	-2.97	-2.68	-3.04
	Median	-1.08	-1.01	-1.05	-1.45	-1.43	-0.55	-1.1	-0.59	-0.30	-0.26	-0.64	-0.11	-0.04	-0.14	-0.15	-0.97	-0.78	-1.10	-0.27	-3.9	-0.70	-0.97	-0.57	-1.02
	95 th ptile	1.85	1.53	1.57	0.85	0.73	2.23	7.3	4.55	2.73	2.70	3.80	4.65	2.12	2.81	2.68	3.64	2.46	1.88	2.65	36.1	4.31	5.90	3.70	3.35
Jun 10	Mean	0.08	0.24	-0.08	-0.26	-0.24	0.83	2.05	0.81	0.49	0.54	0.48	0.94	0.44	0.50	0.50	0.22	0.02	-0.19	1.28	7.0	0.75	0.66	0.58	0.24
	SD	1.25	1.20	1.05	1.06	1.06	1.24	3.42	1.95	1.19	1.15	1.53	1.90	0.90	1.15	1.13	1.51	1.08	1.08	1.35	15.4	1.90	2.36	1.65	1.61
	5 th ptile	-2.07	-2.15	-1.91	-2.25	-2.24	-1.33	-3.81	-2.39	-1.33	-1.25	-1.58	-2.12	-1.01	-1.34	-1.33	-1.97	-1.71	-2.01	-1.11	-14.1	-1.97	-1.95	-1.71	-2.04
	Median	-0.01	0.27	-0.09	-0.20	-0.18	0.89	1.91	0.67	0.38	0.43	0.25	0.82	0.39	0.40	0.44	-0.04	-0.08	-0.26	1.35	3.9	0.43	-0.02	0.25	-0.02
	95 th ptile	2.12	2.12	1.69	1.45	1.55	3.12	8.24	4.56	2.78	2.74	3.21	4.37	1.98	2.54	2.48	3.14	2.10	1.76	3.46	36.3	4.30	5.41	3.69	3.16
Jul 10	Mean	0.57	0.77	0.37	0.29	0.25	1.65	1.7	1.82	1.11	1.15	1.09	2.13	1.00	1.15	1.16	0.82	0.57	0.29	1.87	13.1	1.46	1.40	1.25	0.86
	SD	1.26	1.12	1.08	1.01	0.97	1.03	1.03	2.01	1.25	1.20	1.72	2.08	0.95	1.26	1.22	1.78	1.24	1.17	1.14	17.3	2.10	3.37	1.86	1.83
	5 th ptile	-1.53	-1.22	-1.41	-1.68	-1.67	-0.26	-0.3	-1.30	-0.82	-0.67	-1.17	-1.12	-0.55	-0.86	-0.80	-1.69	-1.36	-1.65	-0.46	-9.09	-1.27	-2.12	-1.10	-1.54
	Median	0.49	0.76	0.24	0.31	0.25	1.74	1.7	1.62	0.96	1.02	0.75	1.93	0.97	1.01	1.05	0.39	0.34	0.15	1.95	8.41	0.99	0.33	0.75	0.42
	95 th ptile	2.59	2.55	2.25	2.01	1.79	3.54	3.5	5.32	3.29	3.15	4.37	5.68	2.54	3.31	3.18	4.19	2.72	2.31	3.61	47.1	5.77	8.97	4.96	4.68
Aug 10	Mean	-0.03	-0.01	-0.16	-0.32	-0.31	1.01	1.0	1.05	0.59	0.56	0.46	1.72	0.76	0.81	0.88	0.57	0.33	0.00	1.01	7.0	0.76	0.76	0.62	0.25
	SD	1.18	0.98	0.94	0.83	0.85	0.96	0.96	1.86	1.12	1.03	1.46	2.27	0.98	1.26	1.30	1.95	1.34	1.20	0.95	15.1	1.87	2.80	1.61	1.57
	5 th ptile	-1.94	-1.76	-1.67	-1.84	-1.80	-0.77	-0.8	-1.96	-1.24	-1.08	-1.52	-1.55	-0.71	-1.04	-0.96	-1.81	-1.38	-1.77	-0.74	-12.1	-1.63	-2.12	-1.36	-1.73
	Median	-0.08	0.07	-0.19	-0.24	-0.24	1.09	1.1	0.89	0.47	0.46	0.14	1.40	0.65	0.60	0.63	0.00	0.03	-0.16	1.05	2.92	0.35	-0.06	0.21	-0.05
	95 th ptile	1.89	1.52	1.53	0.97	1.00	2.49	2.5	4.38	2.62	2.42	3.42	5.94	2.46	3.17	3.20	4.47	2.86	2.21	2.46	38.7	4.69	7.04	3.89	3.47

Notes: Layouts A, B, C and D refer to the location of the sensors per Figures 25 through 28.

Abbreviations: NA, not available; ptile, percentile; SD, standard deviation.

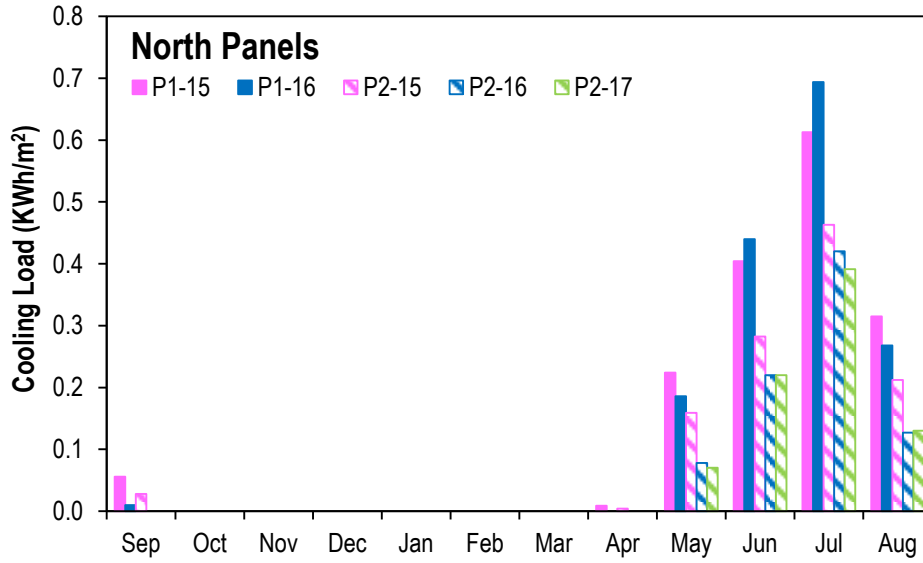

Figure 29. Monthly cooling loads from panels facing north.

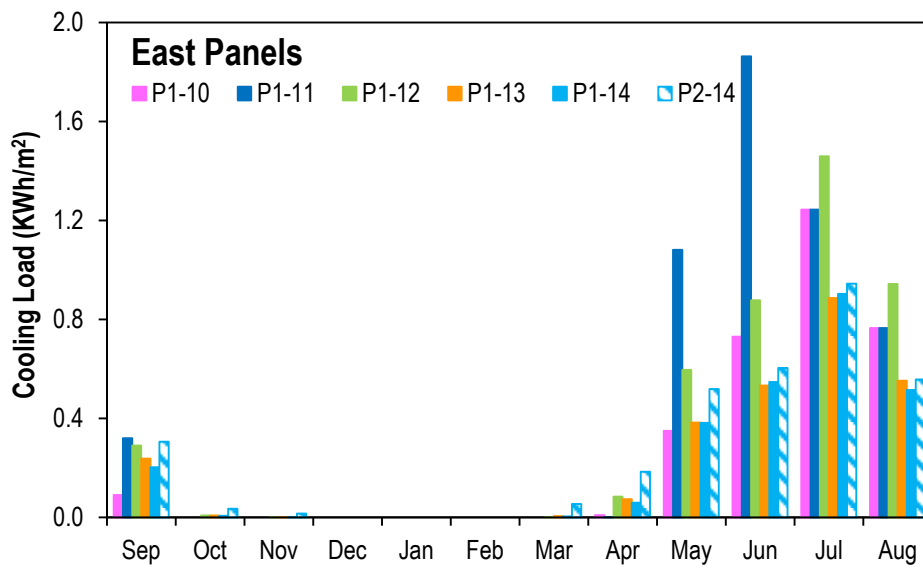

Figure 30. Monthly cooling loads from panels facing east.

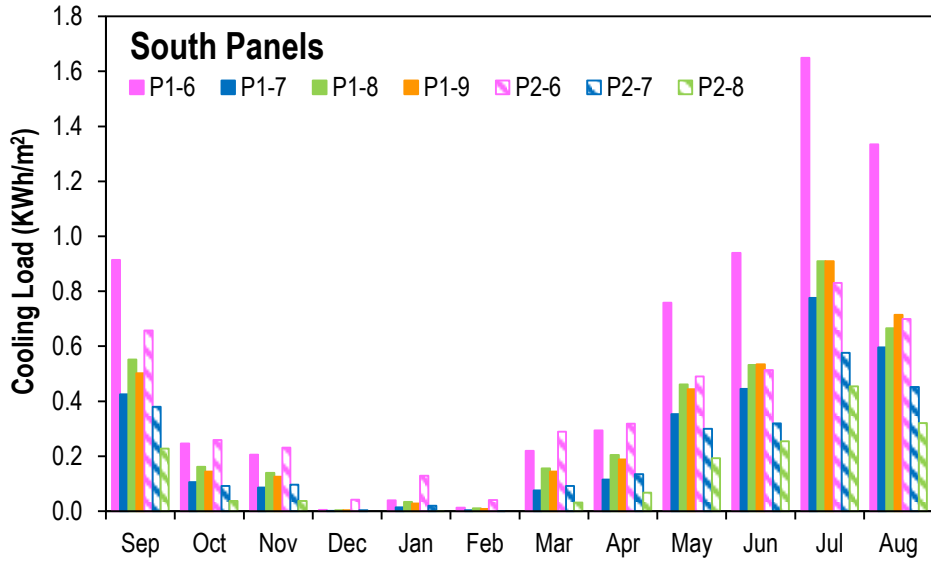

Figure 31. Monthly cooling loads from panels facing south.

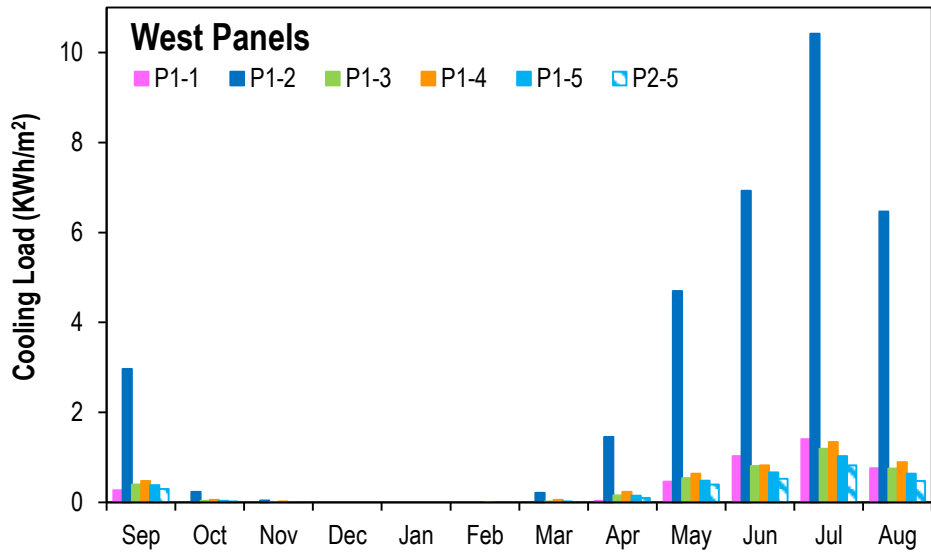

Figure 32. Monthly cooling loads from panels facing west.

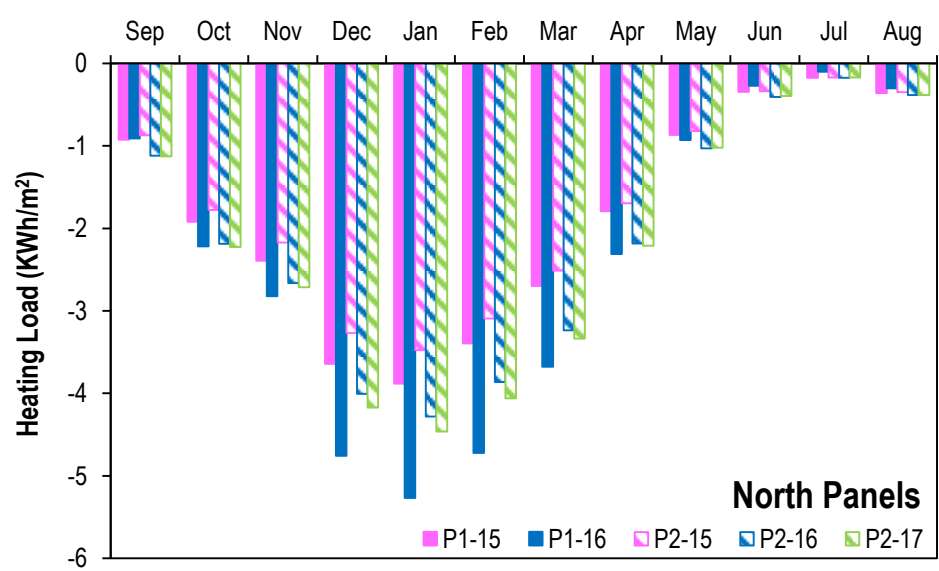

Figure 33. Monthly heating loads from panels facing north.

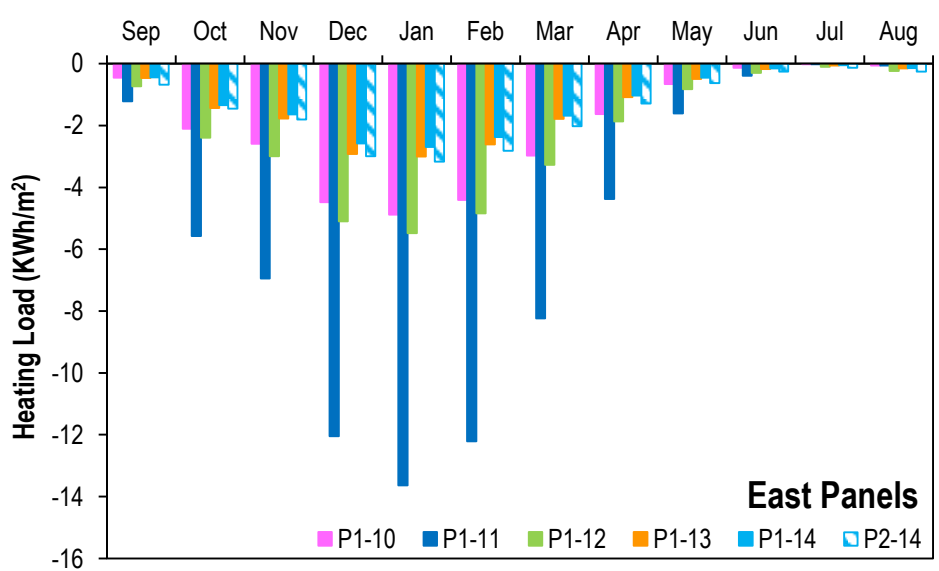

Figure 34. Monthly heating loads from panels facing east.

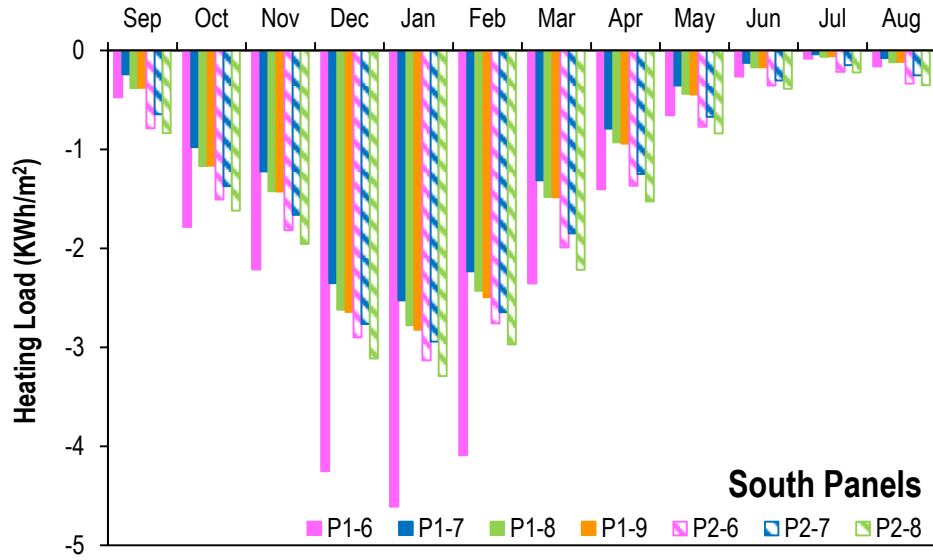

Figure 35. Monthly heating loads from panels facing south.

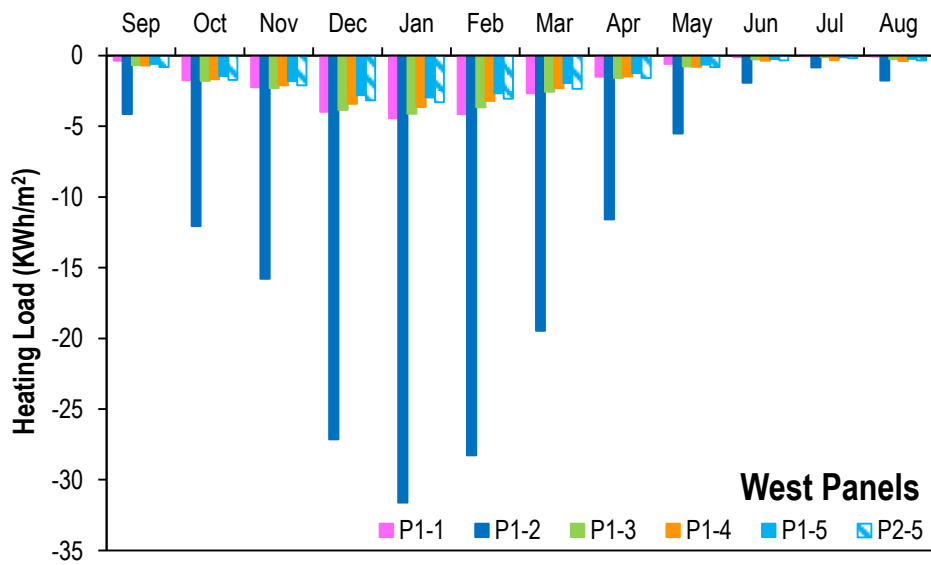

Figure 36. Monthly heating loads from panels facing west.

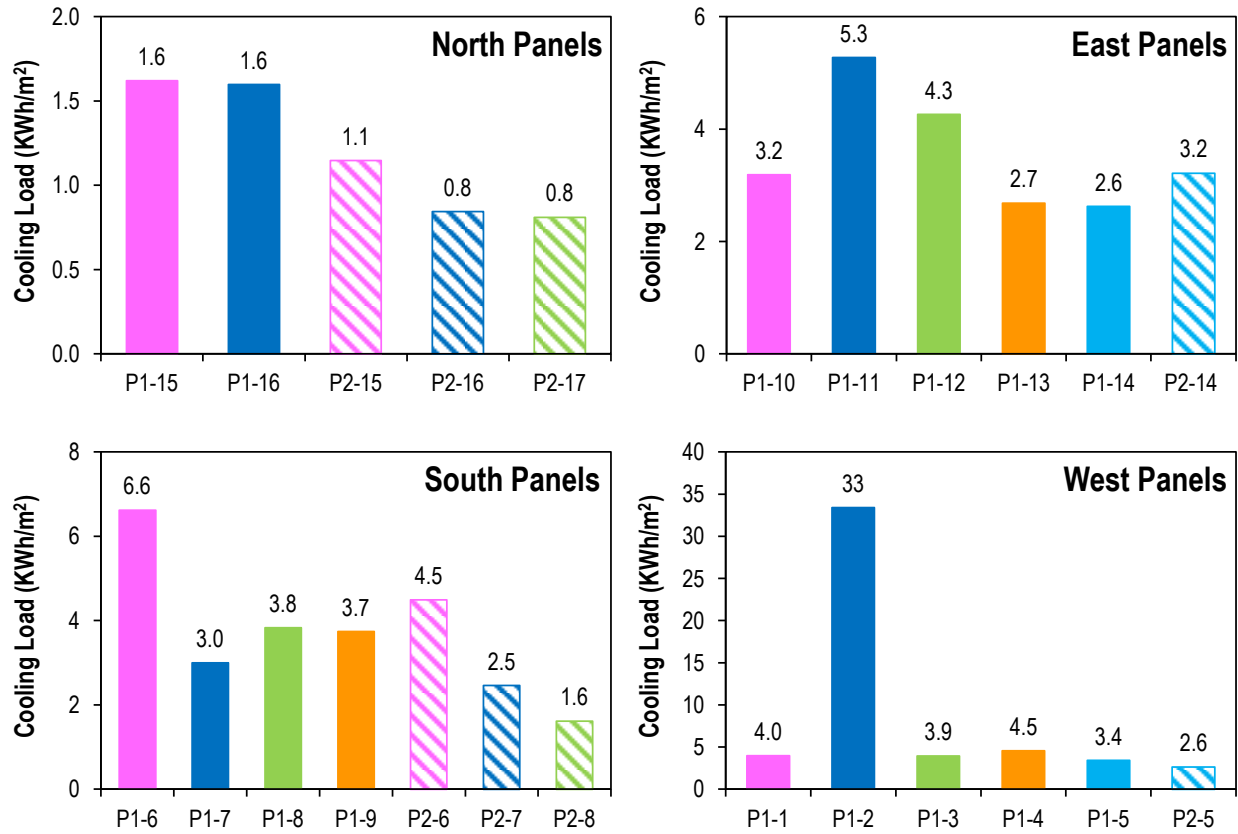

Figure 37. Annual cooling loads.

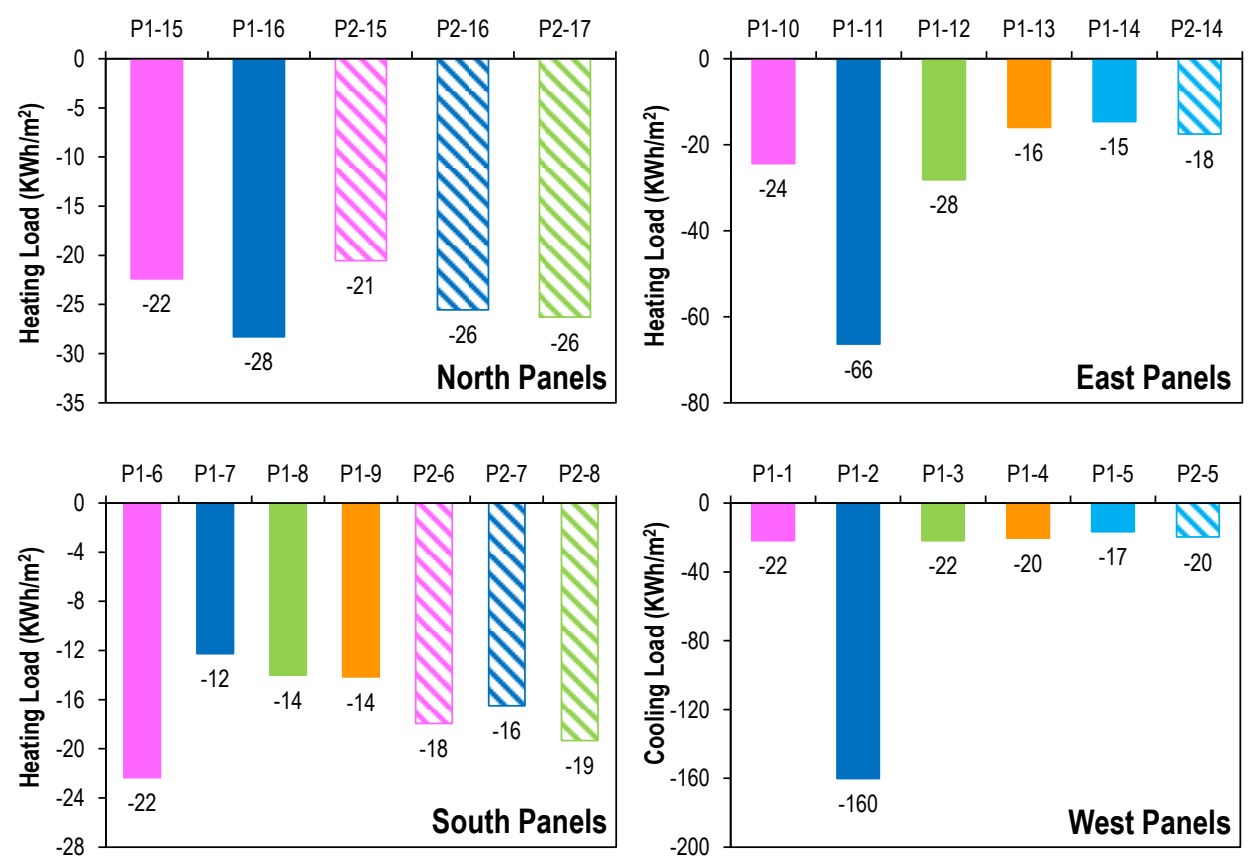

Figure 38. Annual heating loads.

Table 7. Monthly total solar insolation (kW/m²) on each side of the BEST lab.

Month	East	North	South	West
Sep 09	34	13	56	37
Oct 09	28	13	62	30
Nov 09	33	12	81	30
Dec 09	23	13	60	24
Jan 10	29	20	64	32
Feb 10	31	27	56	37
Mar 10	65	27	116	67
Apr 10	73	29	104	84
May 10	82	46	94	99
Jun 10	67	46	72	94
Jul 10	87	49	97	112
Aug 10	73	34	97	83

Table 8. Monthly average wind speeds (m/s).

Month	Descriptive Statistics	North	East	South	West
Sep 09	Mean	0.42	0.77	1.59	1.49
	SD	0.77	0.42	1.31	1.06
	5 th ptile	0.00	0.14	0.10	0.12
	Median	0.00	0.73	1.19	1.26
	95 th ptile	2.22	1.66	4.14	3.56
Oct 09	Mean	0.82	0.93	1.82	1.80
	SD	1.05	0.52	1.94	1.33
	5 th ptile	0.00	0.11	0.07	0.23
	Median	0.37	0.86	1.15	1.56
	95 th ptile	3.20	1.81	6.38	4.37
Nov 09	Mean	1.49	0.97	1.54	2.14
	SD	1.28	0.52	1.37	1.42
	5 th ptile	0.16	0.13	0.11	0.25
	Median	1.16	0.91	1.04	1.87
	95 th ptile	3.77	1.97	4.58	5.00
Dec 09	Mean	2.38	1.39	2.28	3.17
	SD	6.07	2.02	8.52	3.62
	5 th ptile	0.15	0.13	0.13	0.43
	Median	1.33	1.03	1.41	2.52
	95 th ptile	6.43	3.13	4.89	6.74
Jan 10	Mean	2.02	1.15	1.74	2.80
	SD	3.09	0.81	1.63	2.29
	5 th	0.19	0.14	0.12	0.38
	50 th	1.31	1.02	1.11	2.45
	95 th	5.19	3.07	5.26	5.94
Feb 10	Mean	2.99	1.19	5.12	8.21
	SD	10.4	0.63	20.5	39.6
	5 th ptile	0.27	0.41	0.05	0.59
	Median	1.44	1.14	0.87	3.34
	95 th ptile	5.00	2.43	20.9	5.94
Mar 10	Mean	2.16	1.82	1.21	2.09
	SD	1.46	1.17	1.23	1.16
	5 th ptile	0.14	0.39	0.07	0.37
	Median	2.09	1.50	0.85	1.98
	95 th ptile	4.61	4.27	3.77	3.95
Apr 10	Mean	2.22	0.90	1.49	2.59
	SD	1.58	0.46	1.47	1.50
	5 th ptile	0.21	0.14	0.09	0.35
	Median	2.05	0.91	1.00	2.41
	95 th ptile	5.28	1.67	4.95	5.21

Table 8. Continuation.

Month	Descriptive Statistics	North	East	South	West
May 10	Mean	1.99	0.80	1.31	2.25
	SD	1.41	0.55	1.05	1.59
	5 th ptile	0.19	0.10	0.12	0.22
	Median	1.65	0.69	1.02	1.95
	95 th ptile	4.64	1.90	3.61	5.37
Jun 10	Mean	1.78	0.73	1.55	2.07
	SD	1.30	0.46	1.21	1.21
	5 th ptile	0.14	0.12	0.13	0.31
	Median	1.52	0.63	1.21	1.97
	95 th ptile	4.13	1.65	3.81	4.24
Jul 10	Mean	1.63	0.56	1.53	1.86
	SD	1.23	0.38	1.16	0.96
	5 th ptile	0.10	0.11	0.15	0.37
	Median	1.35	0.44	1.15	1.81
	95 th ptile	4.11	1.29	3.85	3.55
Aug 10	Mean	1.33	0.79	1.50	1.57
	SD	1.12	0.51	1.19	1.04
	5 th ptile	0.10	0.09	0.12	0.21
	Median	1.04	0.75	1.15	1.31
	95 th ptile	3.71	1.83	3.95	3.66

Abbreviations: ptile, percentile; SD, standard deviation.

Table 9. Monthly rain accumulation (mm).

Month	Rain Accumulation (mm)
Sep 09	42
Oct 09	92
Nov 09	39
Dec 09	45
Jan 10	24
Feb 10	21
Mar 10	57
Apr 10	29
May 10	53
Jun 10	151
Jul 10	96
Aug 10	150

Table 10. Weekly and monthly pressure differentials (Pa) across building sides^{a, b}.

Month	Descriptive Statistics	North					East					South					West				
		Weekly				Monthly	Weekly				Monthly	Weekly				Monthly	Weekly				Monthly
		1 st	2 nd	3 rd	4 th		1 st	2 nd	3 rd	4 th		1 st	2 nd	3 rd	4 th		1 st	2 nd	3 rd	4 th	
Sep 09	Mean	-	-	0.19	-0.01	-	-	-	-1.14	-2.16	-	-	-	0.84	3.06	-	-	-	0.78	0.56	-
	SD	-	-	1.50	1.49	-	-	-	2.67	3.60	-	-	-	3.20	5.14	-	-	-	1.54	3.67	-
	Min.	-	-	-5.56	-9.83	-	-	-	-23.7	-28.5	-	-	-	-22.6	-11.4	-	-	-	-12.3	-22.4	-
	5 th ptile	-	-	-1.08	-2.07	-	-	-	-6.25	-9.29	-	-	-	-3.54	-2.50	-	-	-	-1.31	-5.83	-
	25 th ptile	-	-	-0.41	-0.54	-	-	-	-1.87	-3.56	-	-	-	-0.35	-0.11	-	-	-	0.13	-1.07	-
	Median	-	-	-0.22	-0.13	-	-	-	-0.15	-1.07	-	-	-	0.59	1.33	-	-	-	0.71	0.67	-
	75 th ptile	-	-	0.19	0.38	-	-	-	0.45	0.25	-	-	-	1.26	5.21	-	-	-	1.08	2.43	-
	95 th ptile	-	-	3.30	2.46	-	-	-	0.94	1.21	-	-	-	5.89	13.3	-	-	-	3.69	6.46	-
	Max.	-	-	14.4	13.4	-	-	-	5.11	36.5	-	-	-	26.2	39.3	-	-	-	10.6	20.3	-
Oct 09	Mean	-0.08	0.60	-0.12	-0.13	0.05	-1.03	-0.88	0.38	-1.93	-0.97	1.08	0.50	1.16	3.82	1.85	2.19	2.53	1.56	-0.02	1.41
	SD	2.13	2.33	1.43	1.89	1.99	3.11	2.55	1.76	5.48	3.84	3.86	2.76	1.83	8.24	5.44	4.20	2.88	1.63	5.32	4.08
	Min.	-12.2	-11.0	-6.44	-14.1	-14.1	-38.6	-19.1	-14.3	-51.7	-51.7	-27.0	-13.7	-13.7	-13.3	-27.0	-21.0	-8.05	-9.96	-45.8	-45.8
	5 th ptile	-2.95	-2.22	-3.07	-3.18	-2.94	-7.21	-5.92	-3.23	-13.0	-7.43	-4.50	-4.35	-2.28	-3.15	-3.51	-2.66	-1.37	-1.40	-10.8	-3.81
	25 th ptile	-0.66	-0.38	-0.39	-0.63	-0.50	-1.67	-1.89	0.00	-2.61	-1.58	-0.17	-0.74	0.49	0.34	0.09	0.43	0.96	0.90	-0.68	0.53
	Median	-0.25	-0.01	-0.22	-0.21	-0.20	0.01	-0.08	0.82	0.21	0.29	0.95	0.68	1.21	1.15	1.04	1.36	1.94	1.55	0.92	1.39
	75 th ptile	0.23	1.11	0.09	0.24	0.36	0.75	0.72	1.31	0.78	0.91	1.99	1.82	1.91	3.86	2.17	3.07	3.65	2.07	1.83	2.56
	95 th ptile	2.85	5.13	2.05	2.85	3.29	1.57	1.67	2.29	1.85	1.87	6.96	4.84	3.99	22.0	9.55	10.4	8.22	4.27	6.64	7.22
	Max.	36.9	20.5	13.9	16.2	36.9	6.11	6.29	5.38	10.4	10.4	33.2	15.0	12.4	69.9	69.9	37.1	21.3	13.9	23.4	37.1
Nov 09	Mean	0.18	-0.03	0.01	0.38	0.15	-1.28	-0.45	-0.04	-1.17	-0.77	2.10	1.57	0.56	1.07	1.31	2.16	1.07	2.24	2.77	2.11
	SD	2.36	1.30	1.85	3.46	2.47	3.99	2.99	2.12	4.46	3.61	5.02	3.54	2.24	4.29	3.98	3.85	2.16	2.50	4.85	3.66
	Min.	-9.30	-6.56	-8.36	-10.3	-10.3	-34.2	-21.7	-18.0	-39.2	-39.2	-18.7	-11.5	-15.1	-27.9	-27.9	-21.0	-17.6	-9.19	-16.4	-21.0
	5 th ptile	-3.37	-1.89	-3.08	-3.39	-3.10	-9.42	-6.82	-4.26	-10.2	-7.66	-4.17	-2.07	-3.14	-6.13	-3.65	-3.83	-2.87	-1.50	-2.76	-2.72
	25 th ptile	-0.61	-0.39	-0.60	-0.56	-0.52	-2.56	-1.01	-0.81	-2.06	-1.64	-0.06	0.19	-0.35	-0.13	-0.08	0.82	0.65	0.97	0.76	0.81
	Median	-0.24	-0.19	-0.24	-0.23	-0.22	0.00	0.64	0.59	0.56	0.52	1.42	0.92	0.80	1.23	1.07	1.88	1.26	1.77	1.48	1.57
	75 th ptile	0.68	0.31	0.54	0.30	0.44	1.24	1.10	1.20	1.16	1.17	2.96	1.69	1.57	2.43	2.03	3.76	1.88	3.30	3.83	3.07
	95 th ptile	3.88	2.12	3.34	5.79	3.55	2.32	1.92	2.24	2.35	2.21	11.6	9.36	3.44	7.45	7.92	8.48	4.01	6.83	12.2	8.15
	Max.	22.1	14.2	13.9	38.9	38.9	6.22	6.41	6.47	6.44	6.47	48.1	28.3	57.3	30.4	57.3	21.0	16.0	25.6	46.1	46.1
Dec 09	Mean	-0.59	-0.85	1.04	0.24	-0.01	-0.89	-3.09	-0.98	-0.84	-1.39	3.13	3.15	0.28	1.33	1.91	2.04	3.90	4.71	3.91	3.67
	SD	1.98	2.63	3.59	3.59	3.16	3.56	8.98	4.38	5.25	5.93	4.71	6.79	3.60	4.88	5.24	4.34	6.70	4.03	5.59	5.39
	Min.	-16.5	-15.9	-12.0	-11.6	-16.5	-28.3	-67.3	-29.3	-46.5	-67.3	-18.9	-21.9	-22.3	-33.7	-33.7	-25.9	-27.7	-10.3	-14.3	-27.7
	5 th ptile	-4.29	-5.52	-3.79	-3.99	-4.30	-7.98	-14.7	-9.78	-11.6	-11.0	-2.94	-5.00	-6.46	-7.31	-5.59	-4.26	-5.42	-0.85	-2.27	-2.91
	25 th ptile	-1.02	-1.75	-0.55	-0.83	-0.95	-2.22	-4.18	-2.54	-1.91	-2.63	0.85	-0.07	-1.46	-0.15	-0.22	0.37	0.54	2.53	1.40	1.21
	Median	-0.37	-0.49	0.22	-0.31	-0.30	0.10	-0.75	0.23	1.14	0.31	2.33	2.02	1.09	1.93	1.88	1.81	2.64	3.65	2.36	2.61
	75 th ptile	0.05	0.31	2.06	0.43	0.60	1.34	1.18	1.99	1.91	1.66	4.81	4.71	2.46	3.04	3.36	3.57	6.98	6.21	5.14	5.37
	95 th ptile	2.24	2.87	8.29	6.46	4.81	2.75	2.84	3.41	3.53	3.19	11.6	15.3	4.80	7.68	10.3	9.35	16.5	12.8	14.7	13.7
	Max.	13.4	22.9	30.8	38.1	38.1	17.5	46.8	7.19	9.43	46.8	42.4	108	27.1	31.1	108	29.7	41.3	31.0	54.4	54.4

Table 10. Continuation.

Month	Descriptive Statistics	North					East					South					West				
		Weekly				Monthly	Weekly				Monthly	Weekly				Monthly	Weekly				Monthly
		1st	2nd	3rd	4th		1st	2nd	3rd	4th		1st	2nd	3rd	4th		1st	2nd	3rd	4th	
Jan 10	Mean	-0.15	0.48	-0.17	0.07	0.06	-1.04	-0.69	0.51	-1.03	-0.61	-0.06	2.37	1.65	2.59	1.73	6.45	3.27	2.52	3.31	3.83
	SD	2.94	2.46	1.33	3.39	2.73	3.42	3.59	2.11	5.51	4.09	3.08	4.15	2.35	6.27	4.58	3.94	3.24	2.05	6.46	4.73
	Min.	-12.9	-7.80	-8.83	-20.8	-20.8	-33.1	-21.7	-18.8	-53.7	-53.7	-25.9	-16.3	-10.5	-33.1	-33.1	-5.94	-17.1	-11.4	-32.7	-32.7
	5 th ptile	-4.39	-3.34	-2.88	-4.14	-3.77	-7.33	-8.00	-3.56	-11.0	-8.11	-5.75	-3.46	-1.82	-6.4	-4.59	0.98	-1.80	-0.79	-7.7	-1.97
	25 th ptile	-1.63	-0.62	-0.52	-1.08	-0.85	-2.35	-2.10	-0.06	-2.81	-1.91	-1.55	0.40	0.80	-0.16	-0.16	3.87	1.96	1.63	1.30	1.82
	Median	-0.21	-0.07	-0.25	-0.37	-0.25	-0.14	0.37	1.21	0.25	0.50	0.49	2.18	1.68	2.09	1.64	5.86	3.17	2.21	2.88	3.24
	75 th ptile	1.04	1.25	0.27	0.62	0.74	1.12	1.77	1.66	1.87	1.63	1.87	3.78	2.27	4.24	2.98	8.52	4.86	3.34	5.52	5.63
	95 th ptile	4.13	5.44	1.95	6.54	4.55	2.48	3.09	2.73	3.78	3.12	3.97	9.23	4.57	14.8	9.01	13.6	8.56	5.92	13.8	11.6
	Max.	38.1	18.7	9.50	41.1	41.1	6.44	5.24	4.86	43.0	43.0	11.9	30.3	26.5	50.9	50.9	37.7	23.9	22.6	47.1	47.1
Feb 10	Mean	-0.28	-	-	-	-	0.19	-	-	-	-	1.41	-	-	-	-	3.97	-	-	-	-
	SD	1.84	-	-	-	-	2.38	-	-	-	-	2.42	-	-	-	-	3.27	-	-	-	-
	Min.	-11.8	-	-	-	-	-15.7	-	-	-	-	-9.51	-	-	-	-	-3.53	-	-	-	-
	5 th ptile	-3.68	-	-	-	-	-4.51	-	-	-	-	-3.20	-	-	-	-	-0.16	-	-	-	-
	25 th ptile	-0.75	-	-	-	-	-0.96	-	-	-	-	0.08	-	-	-	-	2.00	-	-	-	-
	Median	-0.36	-	-	-	-	0.84	-	-	-	-	1.99	-	-	-	-	2.98	-	-	-	-
	75 th ptile	0.53	-	-	-	-	1.89	-	-	-	-	2.73	-	-	-	-	5.57	-	-	-	-
	95 th ptile	2.72	-	-	-	-	2.86	-	-	-	-	4.77	-	-	-	-	10.4	-	-	-	-
	Max.	9.90	-	-	-	-	4.48	-	-	-	-	11.7	-	-	-	-	22.5	-	-	-	-
May 10	Mean	-	-	-	-	-	-	-	-	-1.24	-	-	-	-	-0.34	-	-	-	-	1.09	-
	SD	-	-	-	-	-	-	-	-	2.29	-	-	-	-	2.39	-	-	-	-	2.17	-
	Min.	-	-	-	-	-	-	-	-	-15.6	-	-	-	-	-14.8	-	-	-	-	-9.23	-
	5 th ptile	-	-	-	-	-	-	-	-	-6.06	-	-	-	-	-3.99	-	-	-	-	-1.15	-
	25 th ptile	-	-	-	-	-	-	-	-	-2.15	-	-	-	-	-1.09	-	-	-	-	-0.04	-
	Median	-	-	-	-	-	-	-	-	-0.39	-	-	-	-	-0.43	-	-	-	-	0.49	-
	75 th ptile	-	-	-	-	-	-	-	-	0.30	-	-	-	-	0.14	-	-	-	-	1.73	-
	95 th ptile	-	-	-	-	-	-	-	-	0.90	-	-	-	-	3.98	-	-	-	-	5.58	-
	Max.	-	-	-	-	-	-	-	-	2.79	-	-	-	-	15.3	-	-	-	-	15.8	-
Jun 10	Mean	-	-	-	-	-	-1.63	-	-	-	-	1.73	-	-	-	-	0.67	-	-	-	-
	SD	-	-	-	-	-	2.16	-	-	-	-	3.83	-	-	-	-	2.58	-	-	-	-
	Min.	-	-	-	-	-	-13.1	-	-	-	-	-7.11	-	-	-	-	-10.6	-	-	-	-
	5 th ptile	-	-	-	-	-	-5.83	-	-	-	-	-3.57	-	-	-	-	-3.14	-	-	-	-
	25 th ptile	-	-	-	-	-	-2.66	-	-	-	-	-0.48	-	-	-	-	-0.61	-	-	-	-
	Median	-	-	-	-	-	-1.08	-	-	-	-	1.07	-	-	-	-	0.34	-	-	-	-
	75 th ptile	-	-	-	-	-	-0.16	-	-	-	-	3.67	-	-	-	-	1.80	-	-	-	-
	95 th ptile	-	-	-	-	-	0.85	-	-	-	-	8.83	-	-	-	-	5.40	-	-	-	-
	Max.	-	-	-	-	-	4.18	-	-	-	-	22.2	-	-	-	-	15.7	-	-	-	-

Table 10. Continuation.

Month	Descriptive Statistics	North					East					South					West				
		Weekly				Monthly	Weekly				Monthly	Weekly				Monthly	Weekly				Monthly
		1 st	2 nd	3 rd	4 th		1 st	2 nd	3 rd	4 th		1 st	2 nd	3 rd	4 th		1 st	2 nd	3 rd	4 th	
Jul 10 ^c	Mean	0.34	0.42	0.07	0.45	0.33	-1.47	-1.68	-1.92	-1.83	-1.79	-1.21	0.81	-0.15	-0.23	0.04	-	0.18	0.55	1.42	-
	SD	0.93	1.45	1.31	2.02	1.63	1.42	2.62	2.33	8.53	5.43	1.44	3.75	2.96	3.55	3.41	-	6.24	1.63	5.65	-
	Min.	-2.13	-5.34	-12.9	-12.5	-12.9	-8.10	-26.7	-21.4	-39.1	-39.1	-7.45	-14.7	-14.8	-23.2	-23.2	-	-38.1	-8.59	-34.9	-
	5 th ptile	-0.80	-0.99	-1.77	-1.43	-1.35	-4.33	-6.94	-6.51	-18.0	-8.54	-3.94	-3.56	-4.81	-5.52	-4.66	-	-5.05	-1.51	-3.33	-
	25 th ptile	-0.21	-0.29	-0.34	-0.52	-0.37	-2.17	-2.52	-3.03	-3.20	-2.85	-1.98	-1.03	-1.53	-1.57	-1.39	-	-1.13	-0.29	-0.10	-
	Median	0.09	-0.02	-0.05	-0.06	-0.03	-1.17	-0.86	-1.26	-0.66	-0.92	-0.98	-0.06	-0.21	-0.36	-0.27	-	-0.03	0.20	0.97	-
	75 th ptile	0.76	0.77	0.50	0.80	0.68	-0.49	-0.09	-0.24	0.15	-0.04	-0.25	1.60	0.86	0.80	0.90	-	1.16	1.19	2.60	-
	95 th ptile	2.21	3.22	2.04	4.66	3.31	0.26	0.95	0.52	9.40	1.44	0.78	8.38	5.29	5.50	6.13	-	6.18	3.65	8.67	-
	Max.	4.61	14.9	14.8	16.2	16.2	1.59	7.59	3.51	57.5	57.5	3.12	37.0	19.9	37.8	37.8	-	34.0	12.4	48.6	-

a. Positive values denote that pressure was higher outdoors than indoors.

b. Data missing (March, April, August and various weeks) due to equipment malfunction.

c. Measurements obtained while Syracuse University pressurized the test hut to characterize the air leakage of wall panels are not included.

Abbreviations: NA, not available; ptile, percentile; SD, standard deviation.

6. References

ASHRAE. 2005. *2005 ASHRAE Handbook – Fundamentals*. Atlanta: American Society of Heating, Refrigeration and Air-Conditioning Engineers, Inc.

Pradhan, Denis; Zhang, Jensen; Thorsell, Thomas; Mocarski, Robbin. 2011. *Air Leakage Measurement of 25 Wall Assemblies with Different Types of Air Barriers*. Report issued by Syracuse University to the Air Barrier Association of America.

Appendix A: North Panels

Temperature ($^{\circ}\text{C}$) at exterior side of stud cavity. Refer to Figures 25 thru 28 for sensor location.

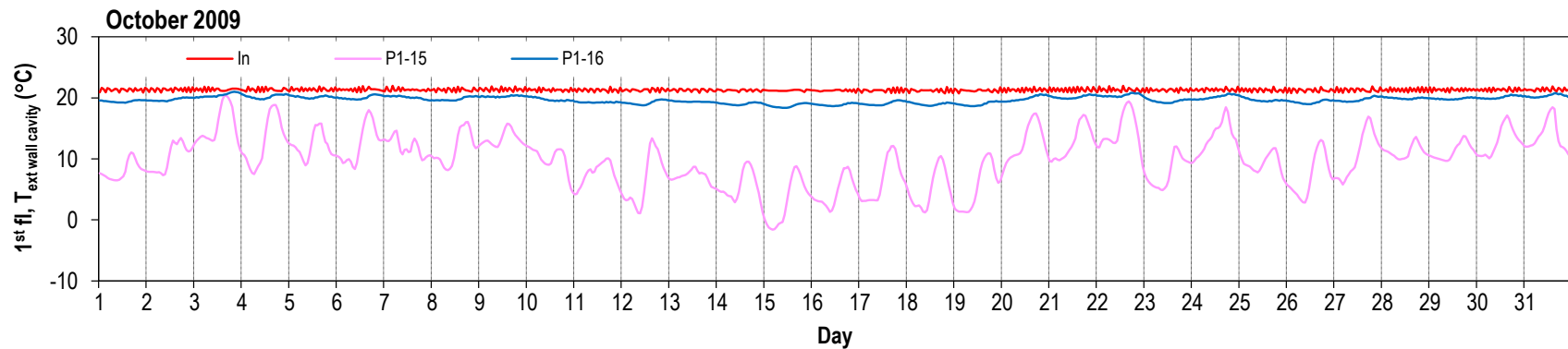
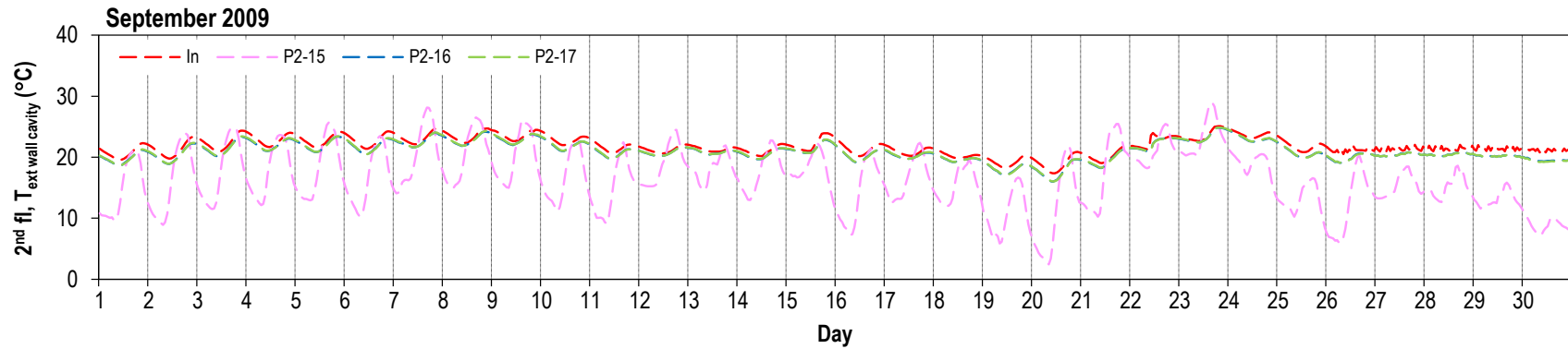
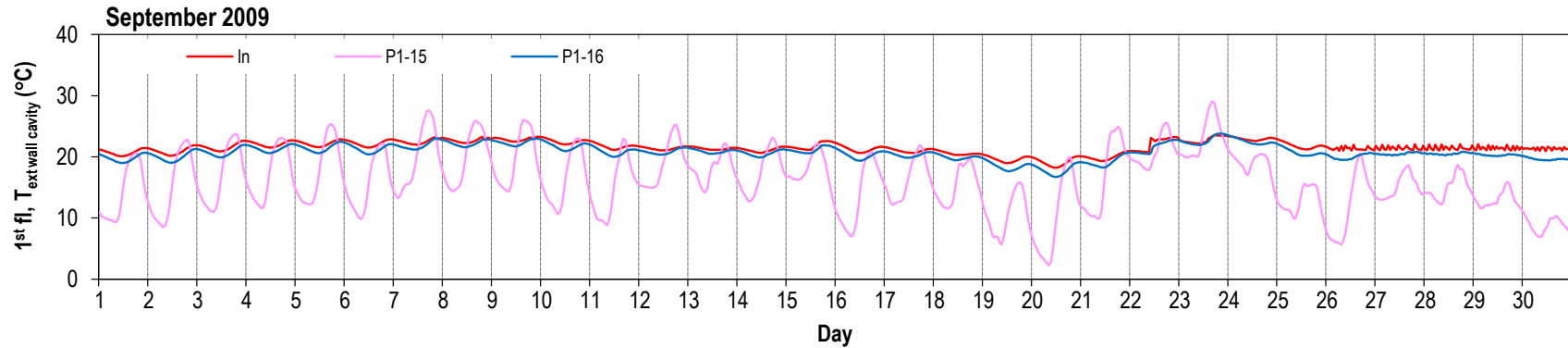

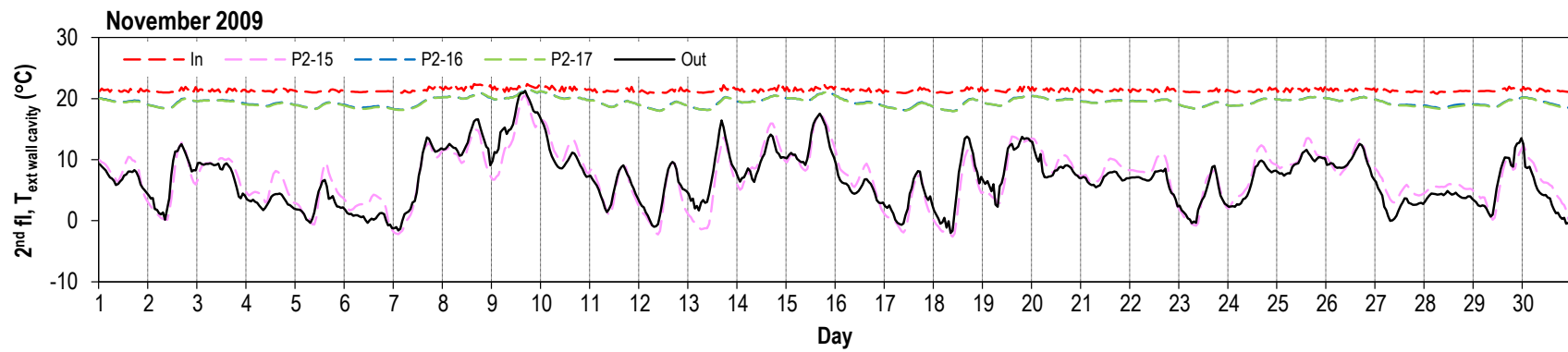
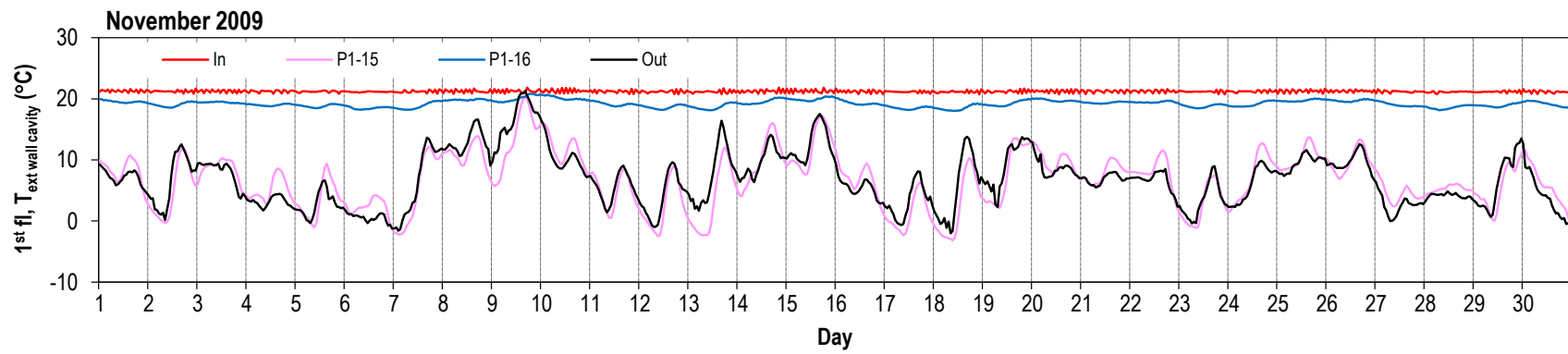
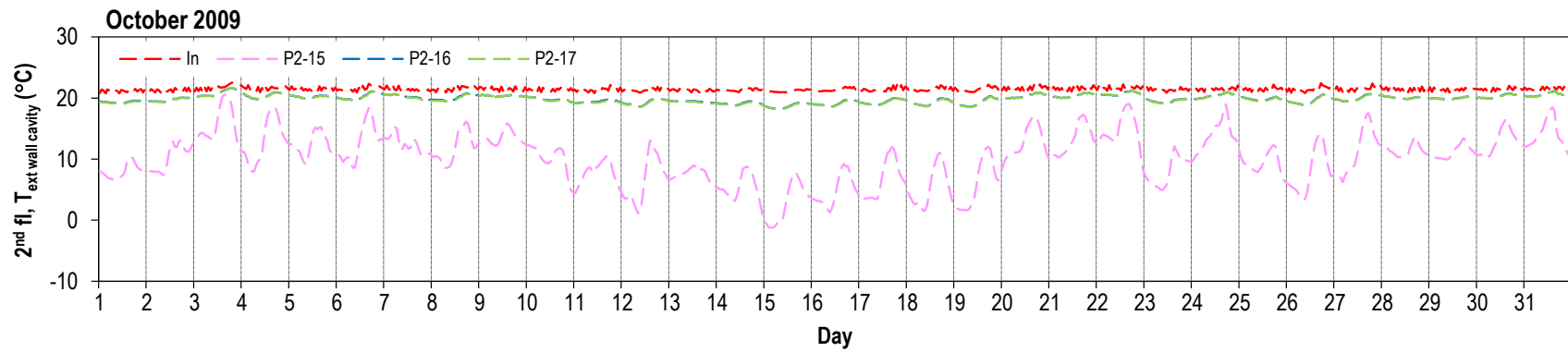

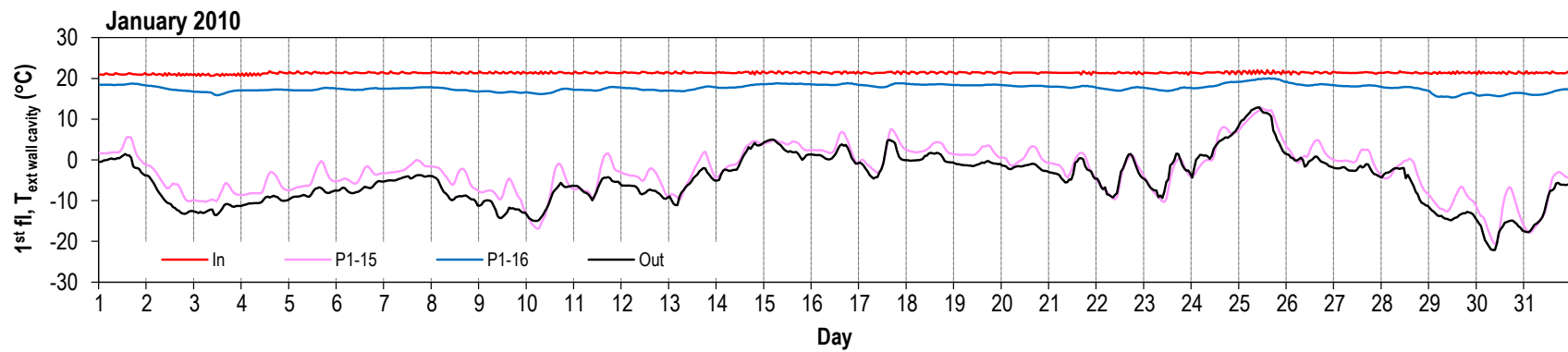
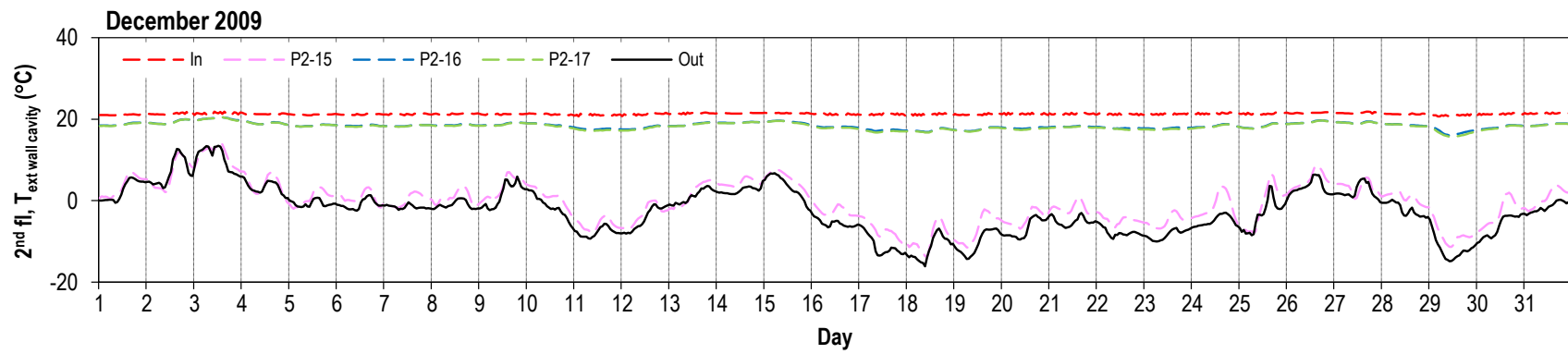
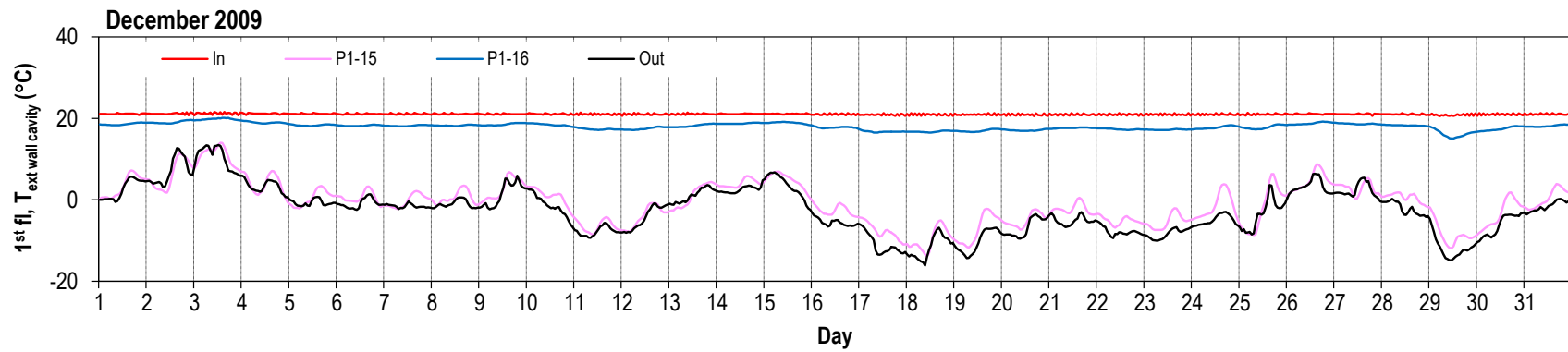

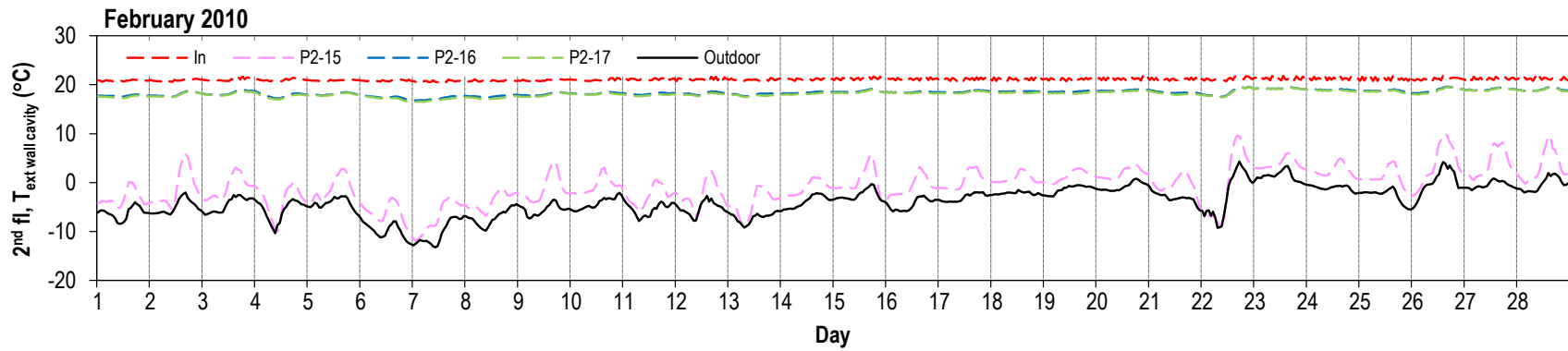
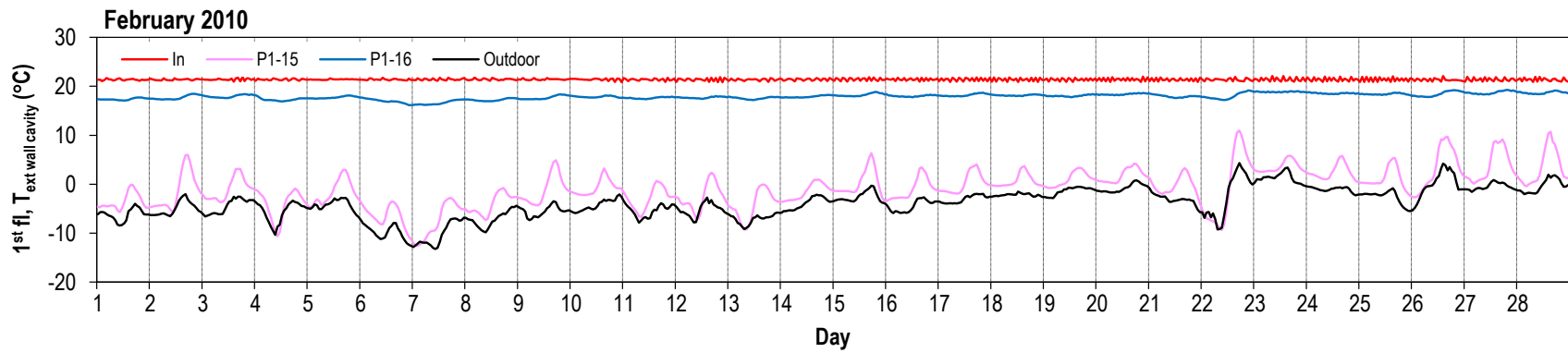
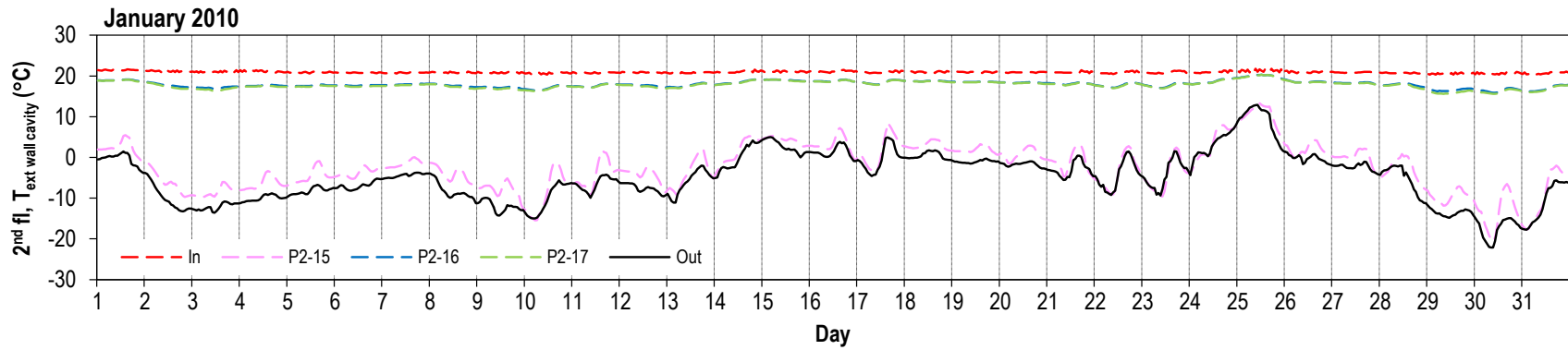

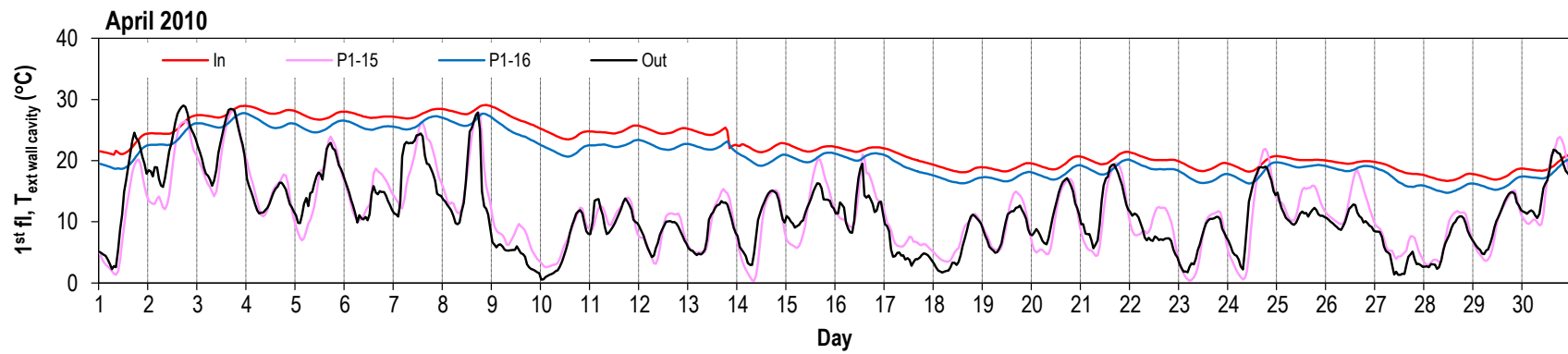
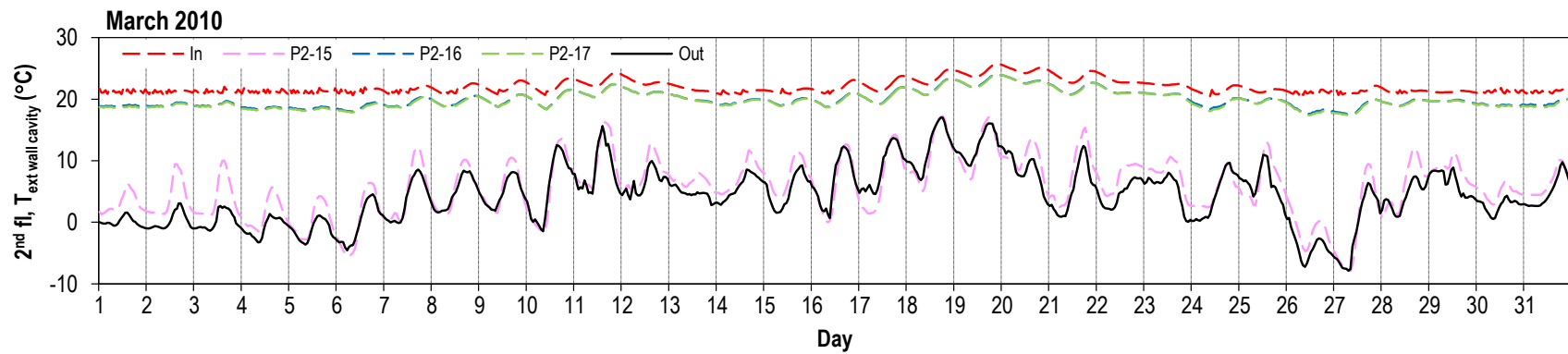
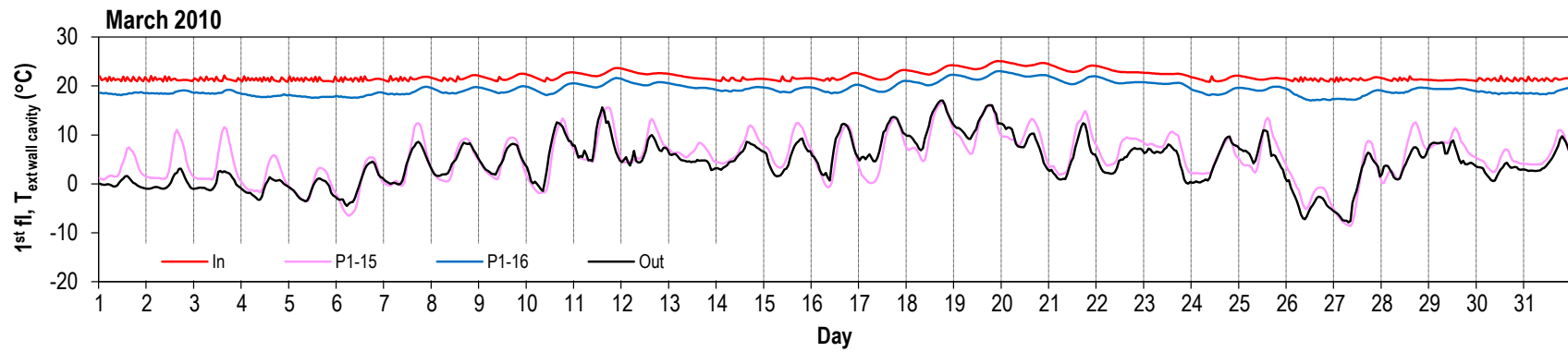

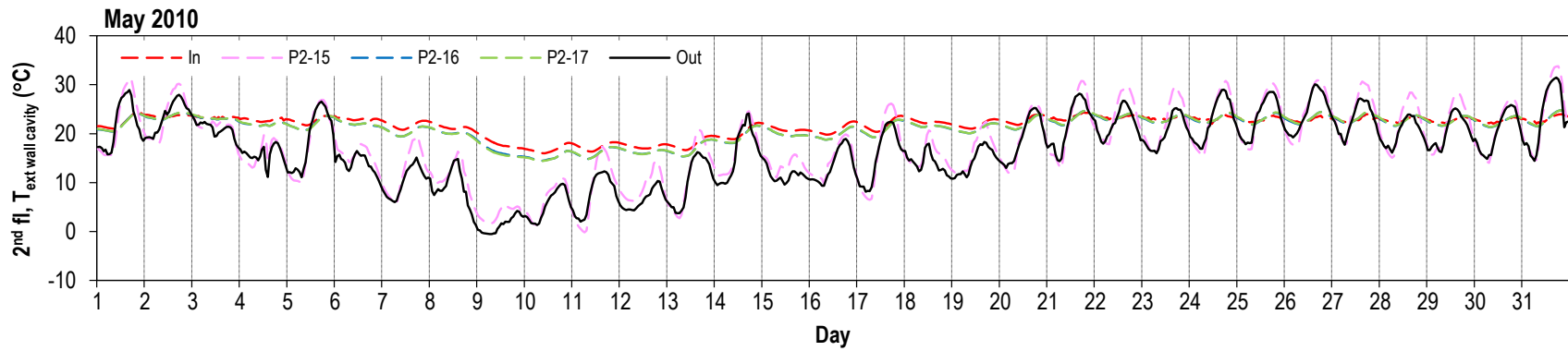
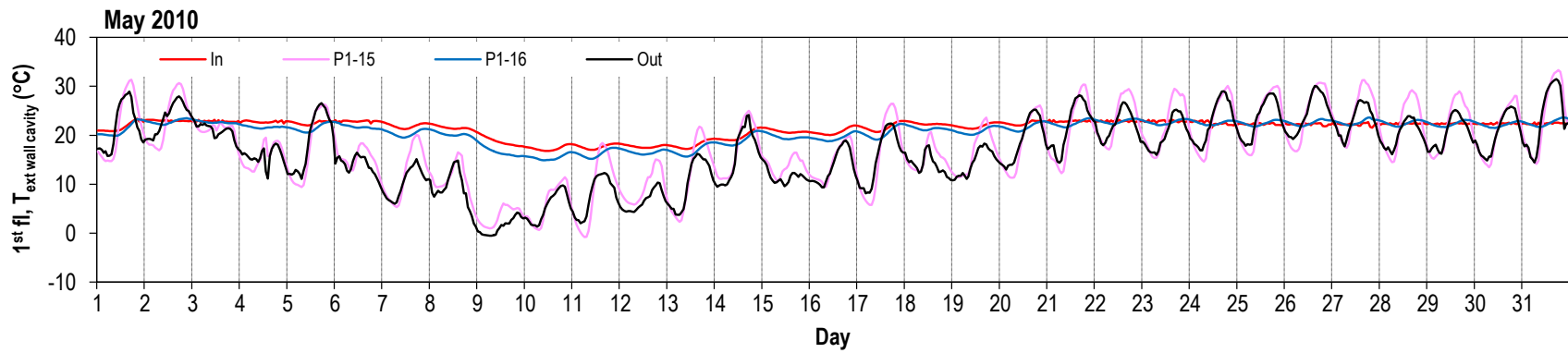
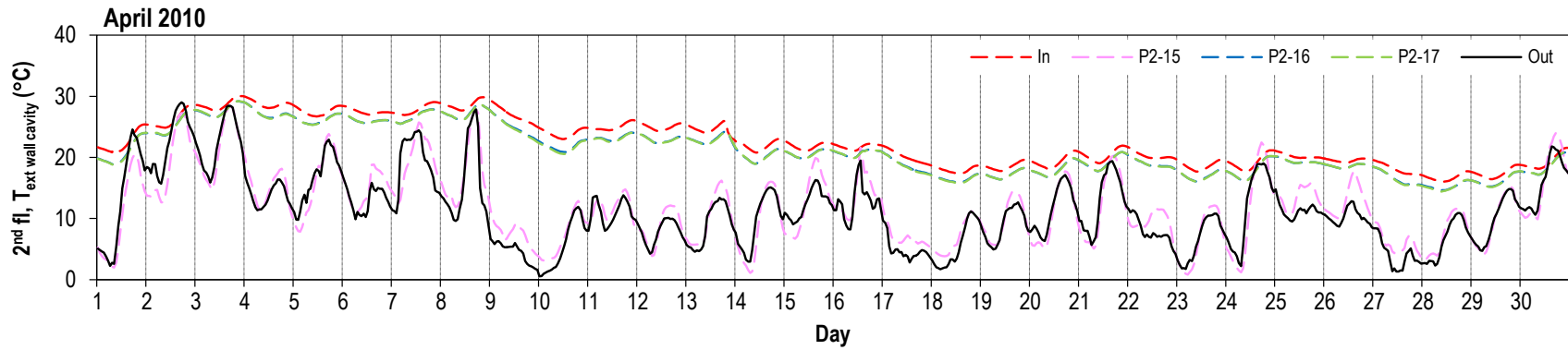

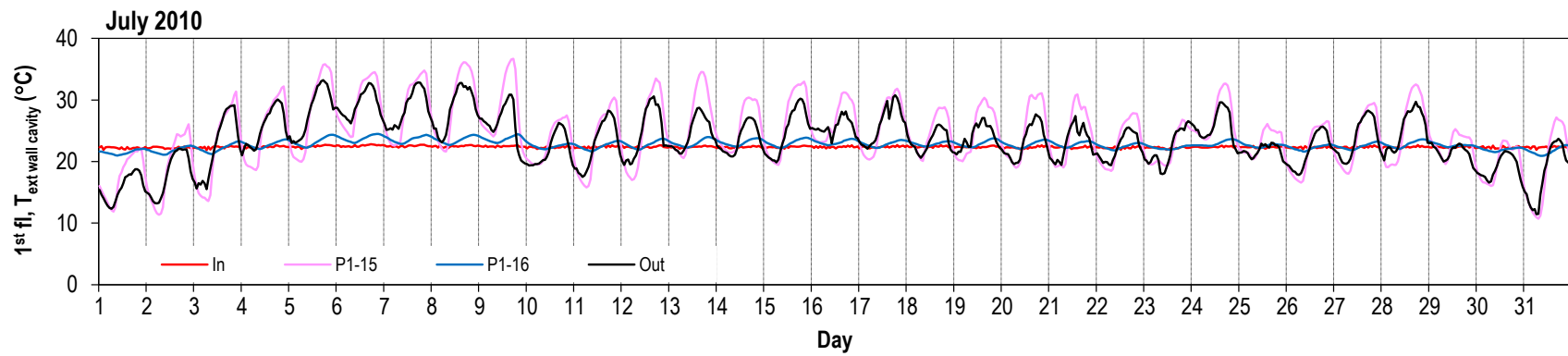
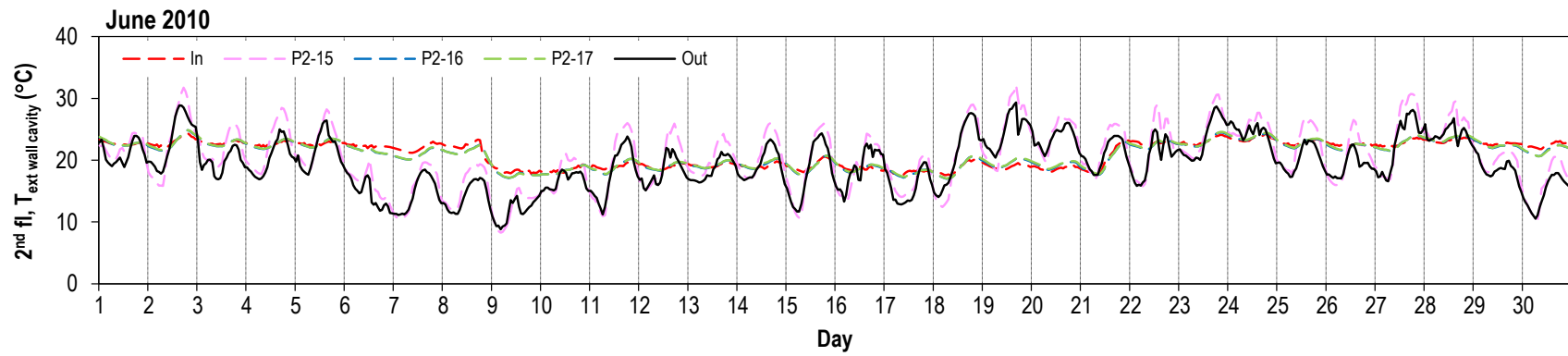
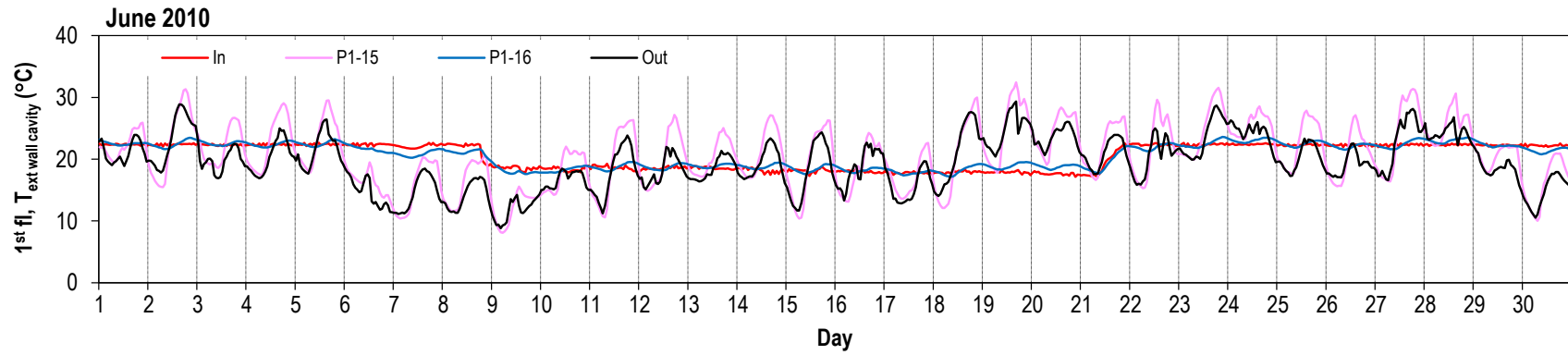

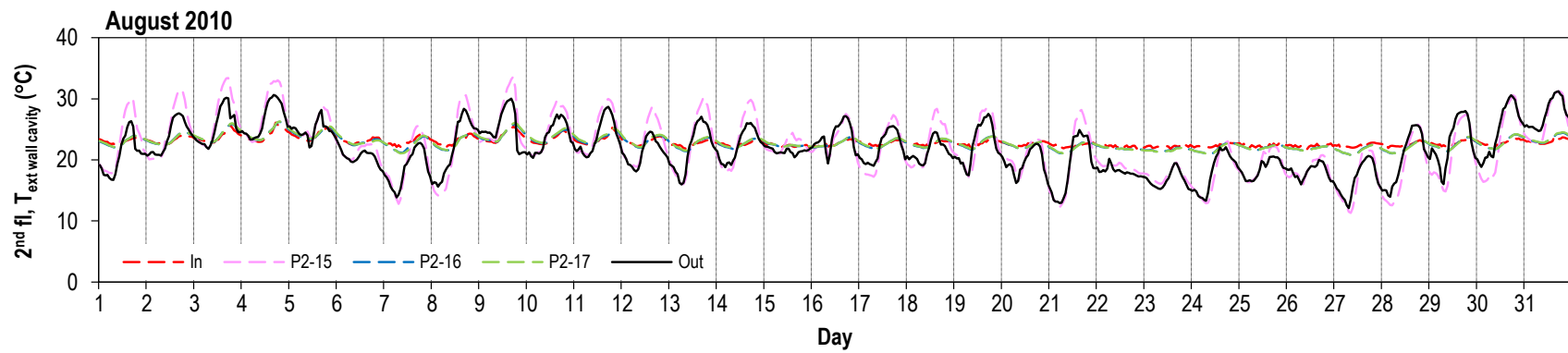
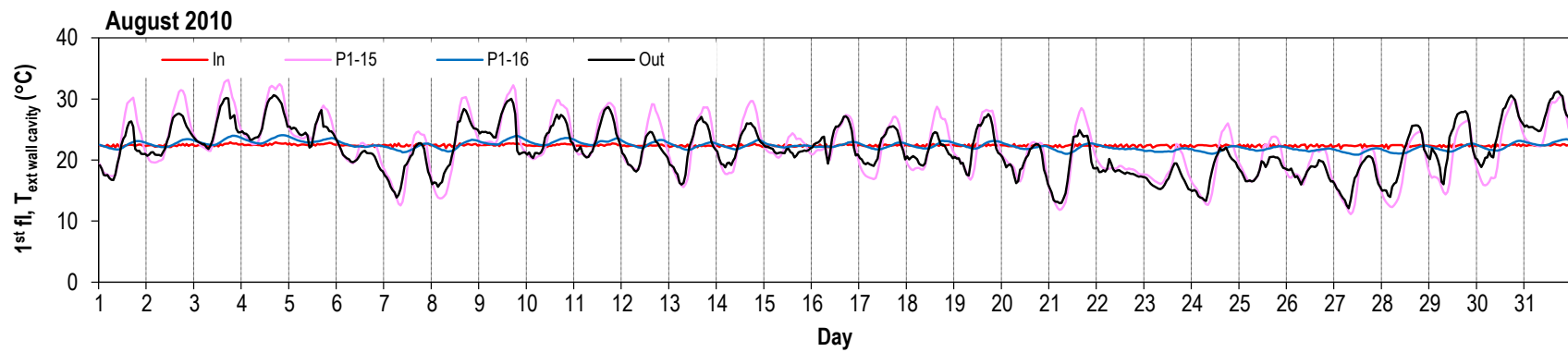
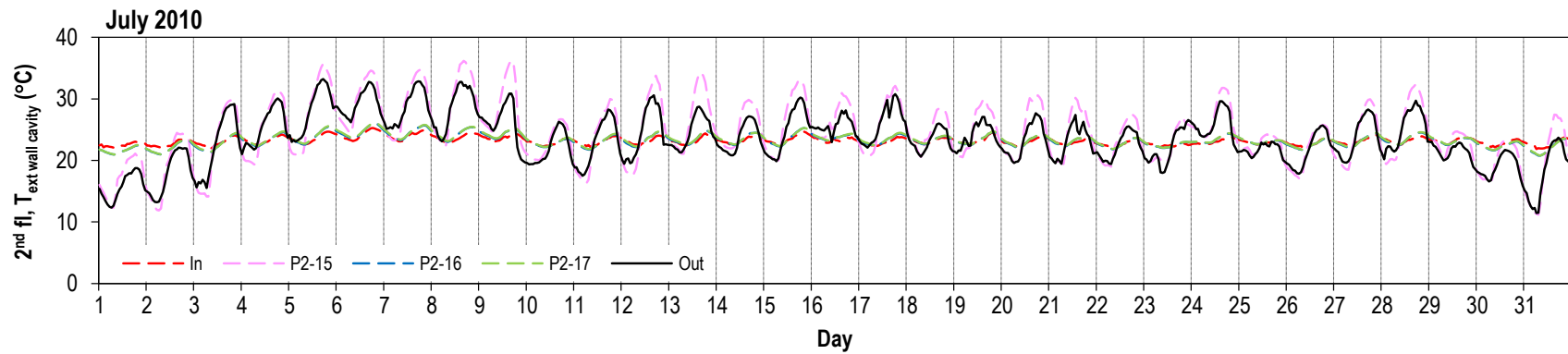

Temperature ($^{\circ}\text{C}$) at interior side of stud cavity. Refer to Figures 25 thru 28 for sensor location.

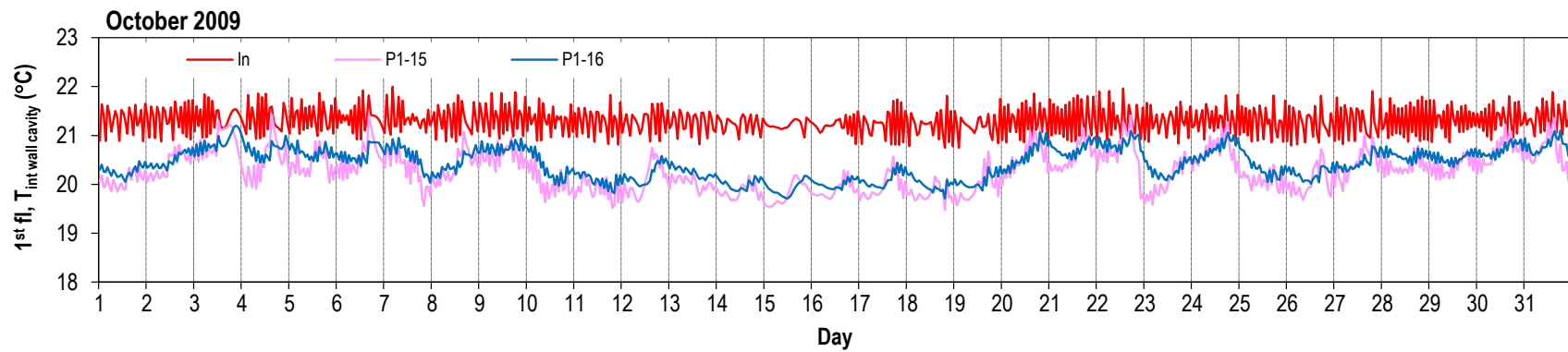
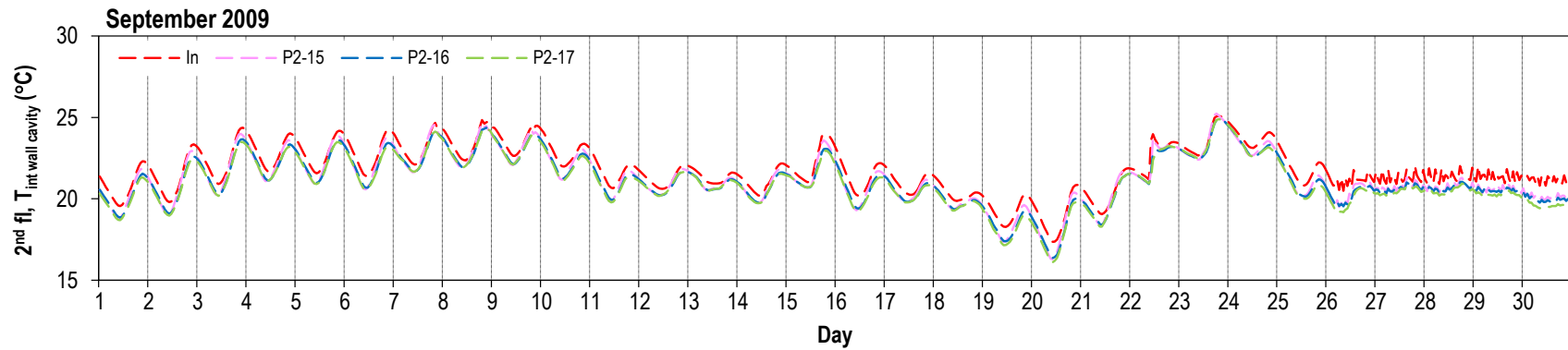
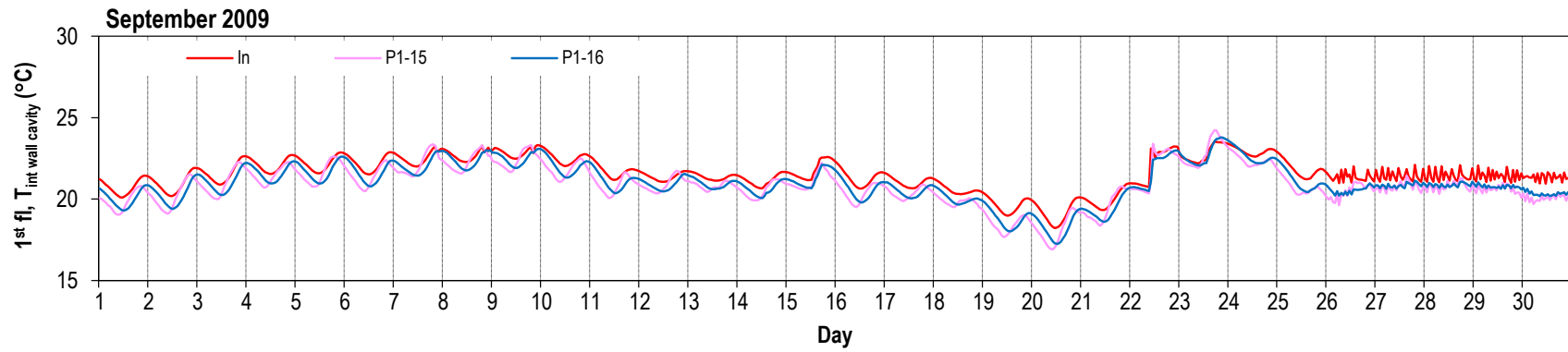

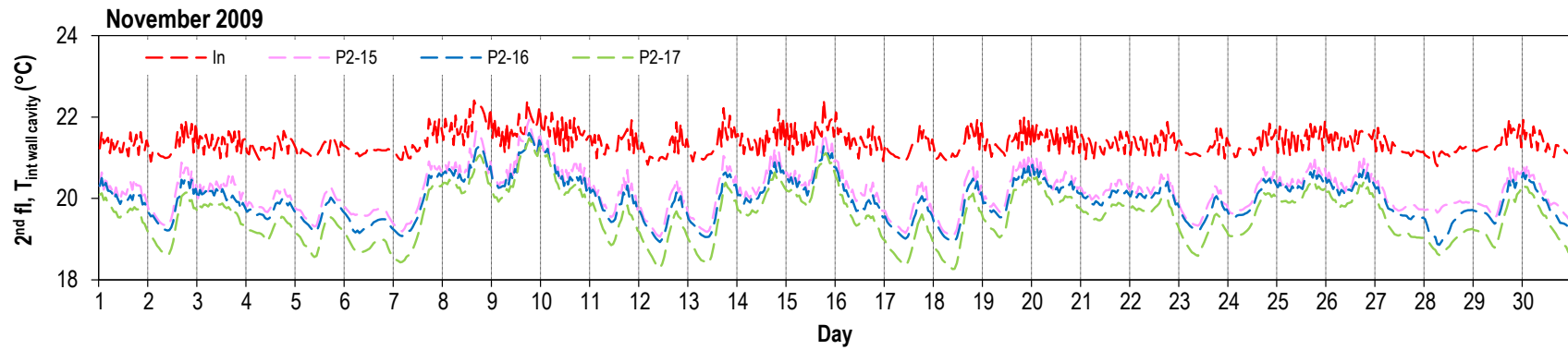
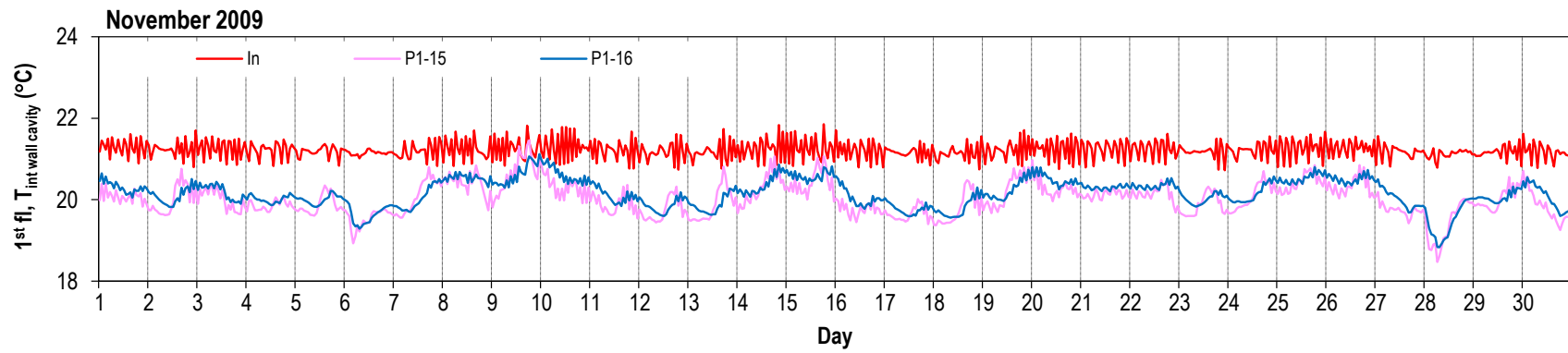
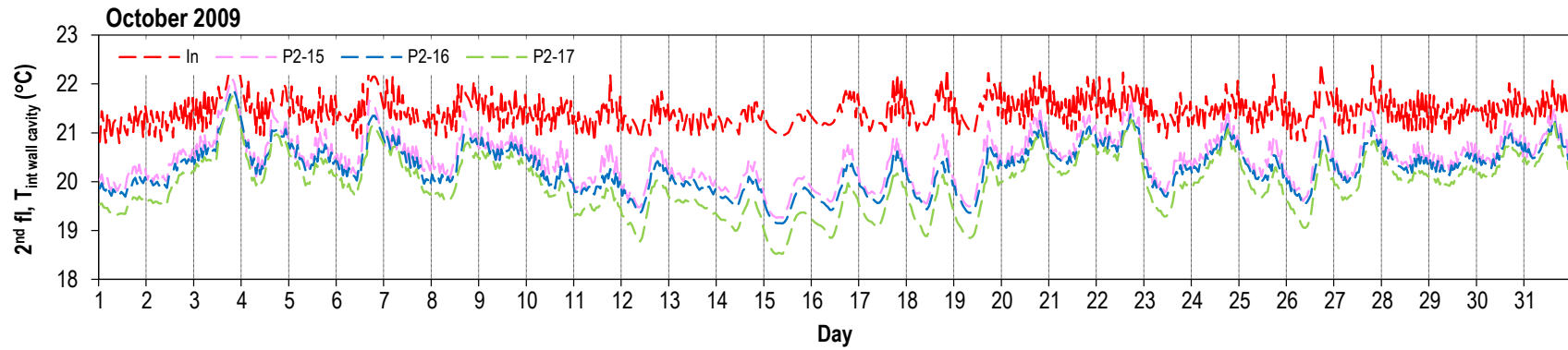

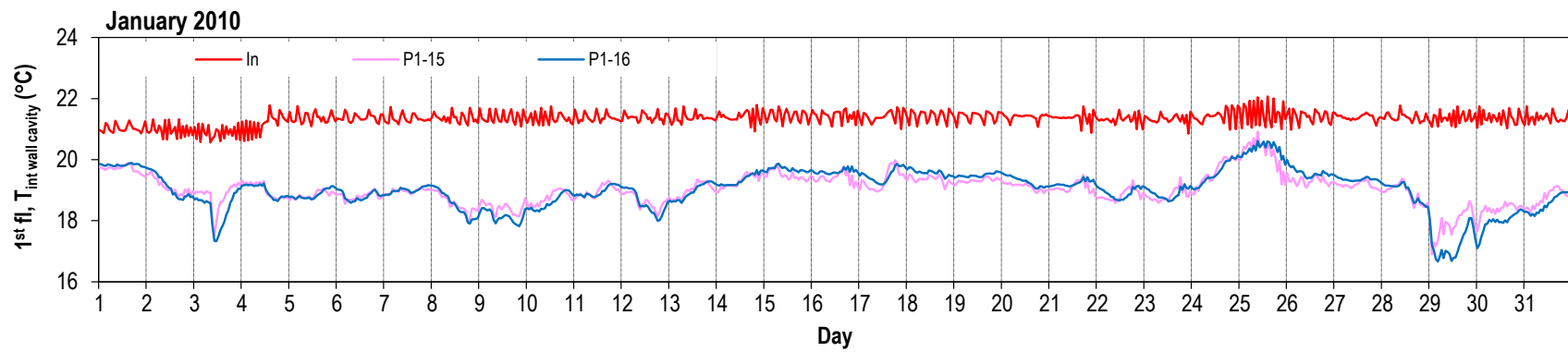
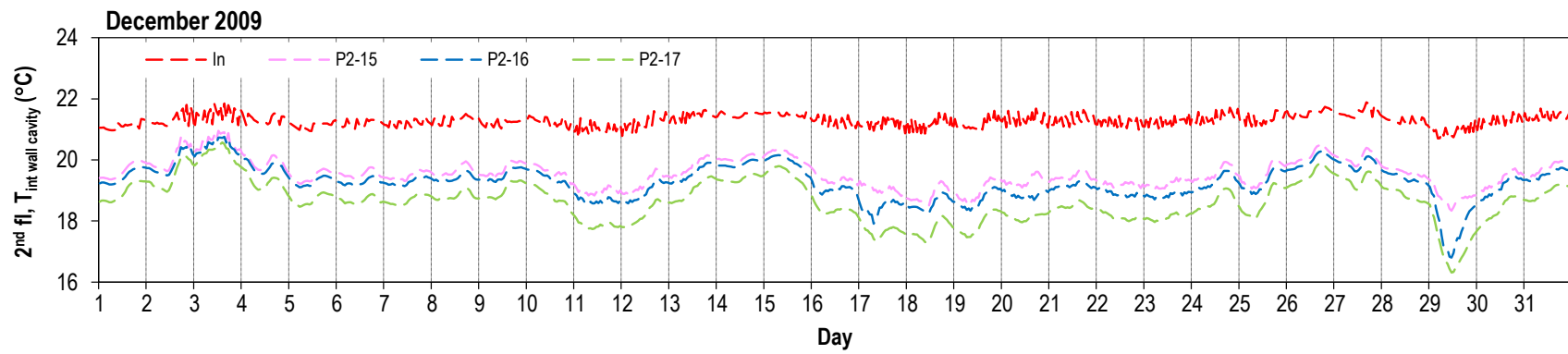
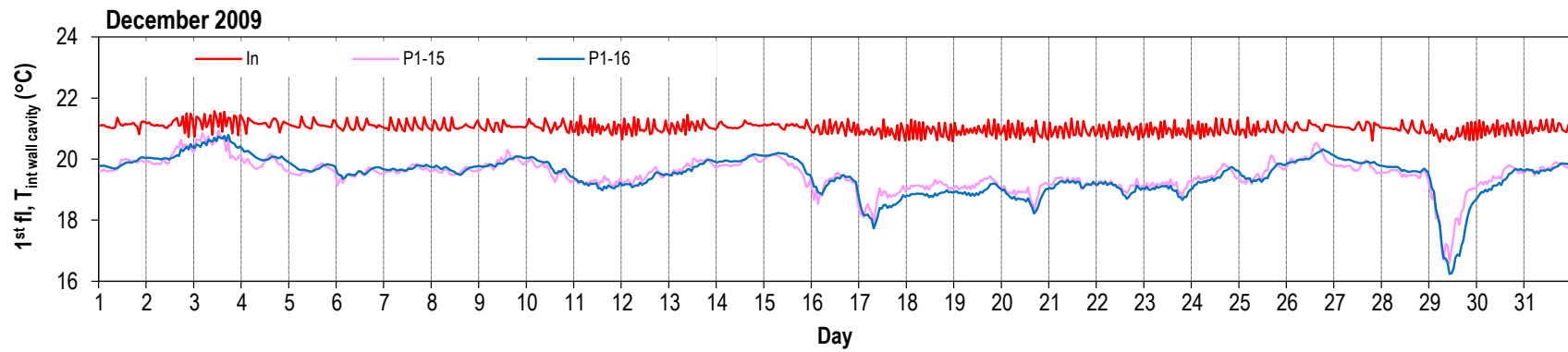

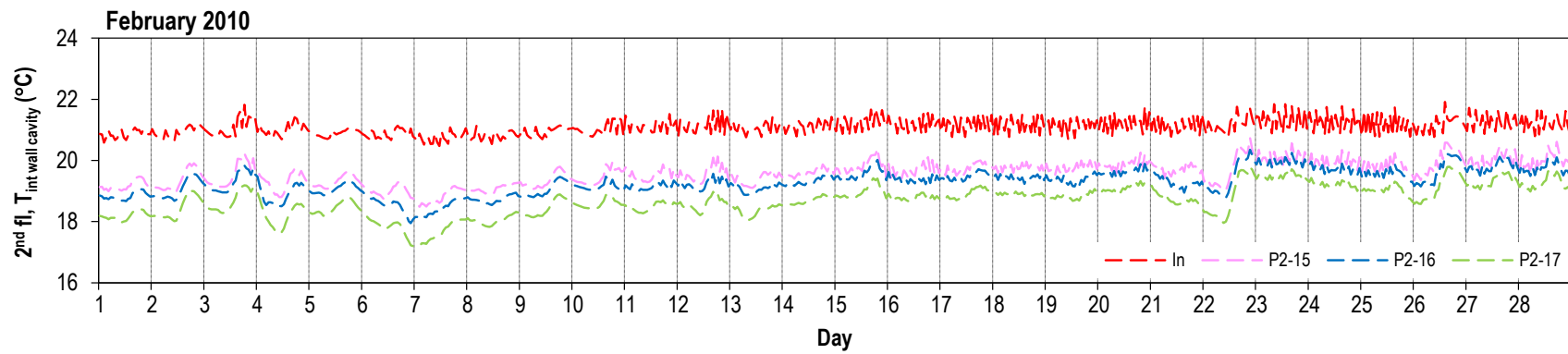
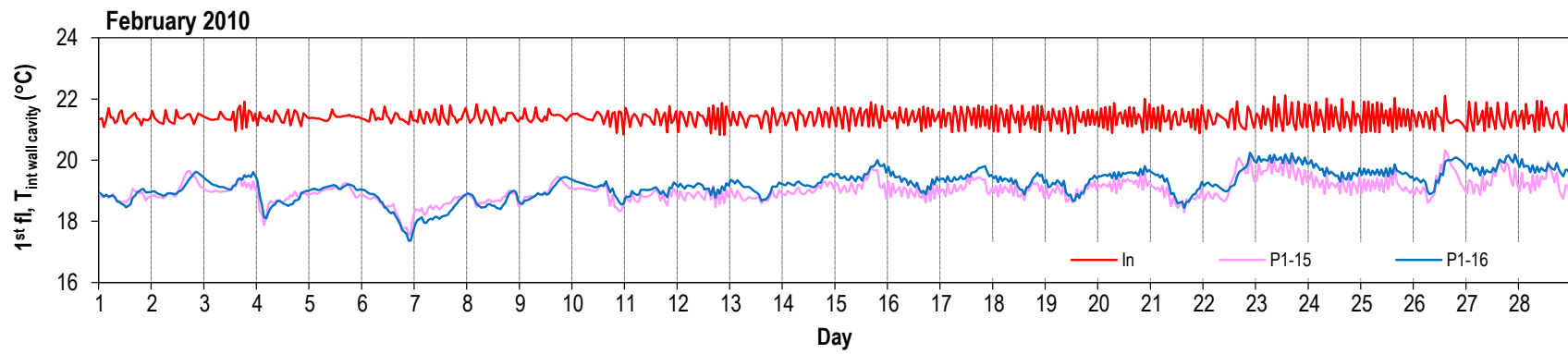
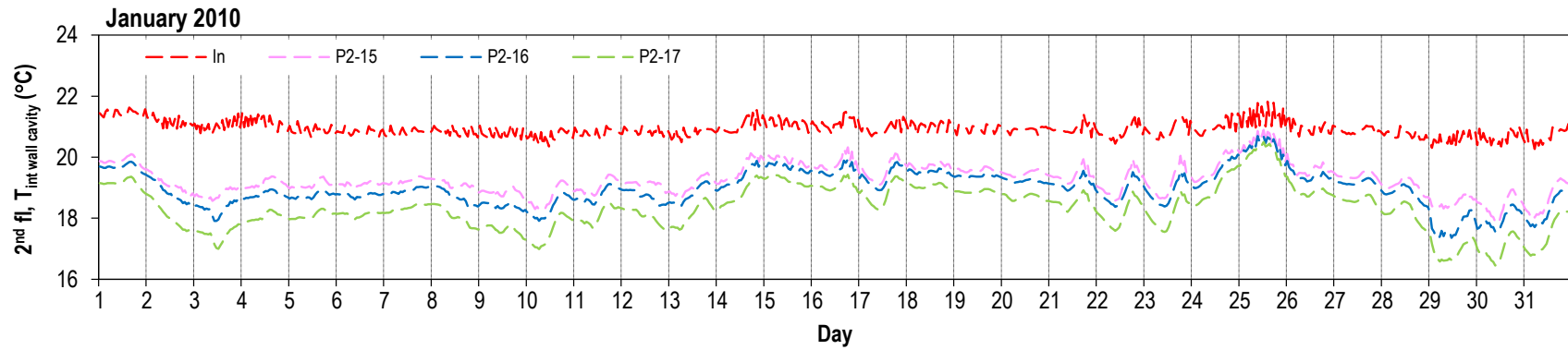

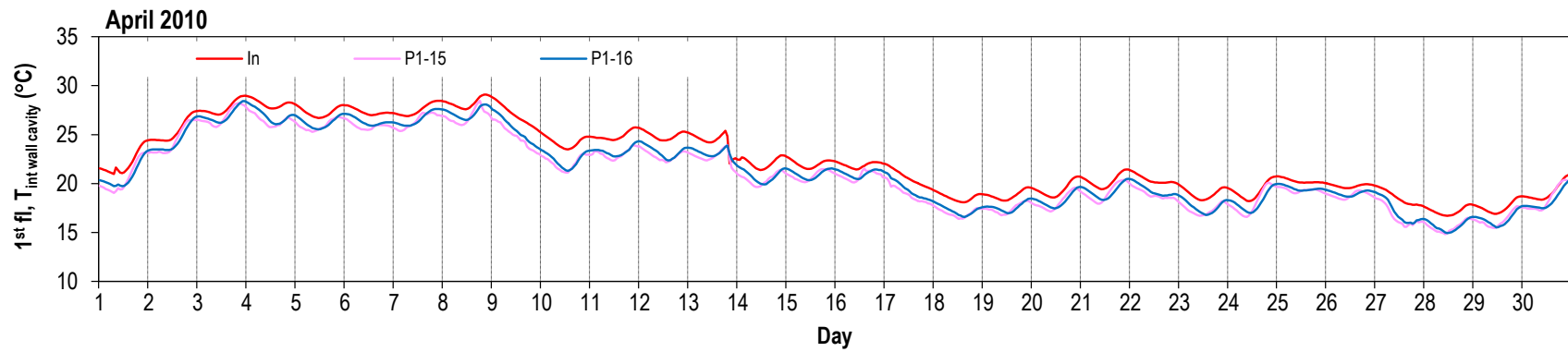
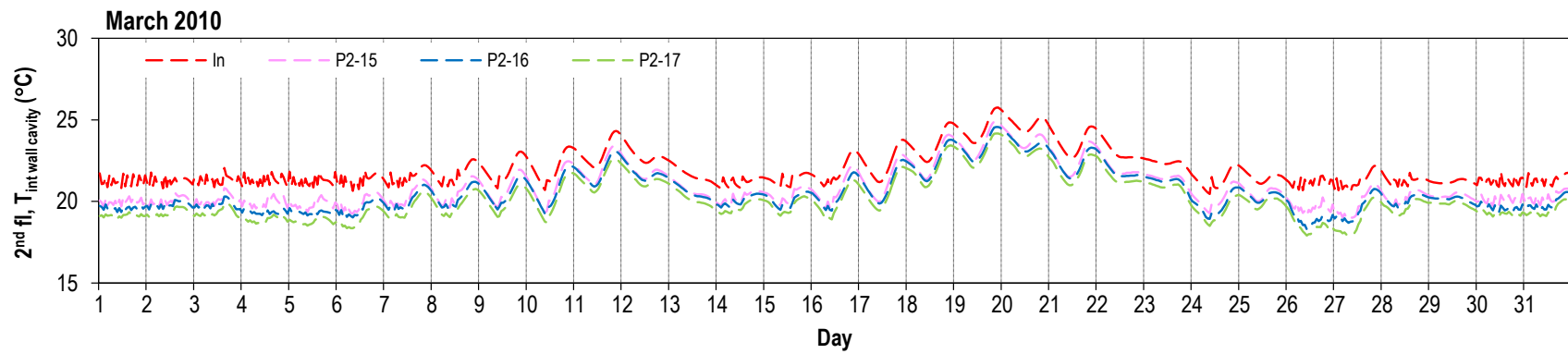
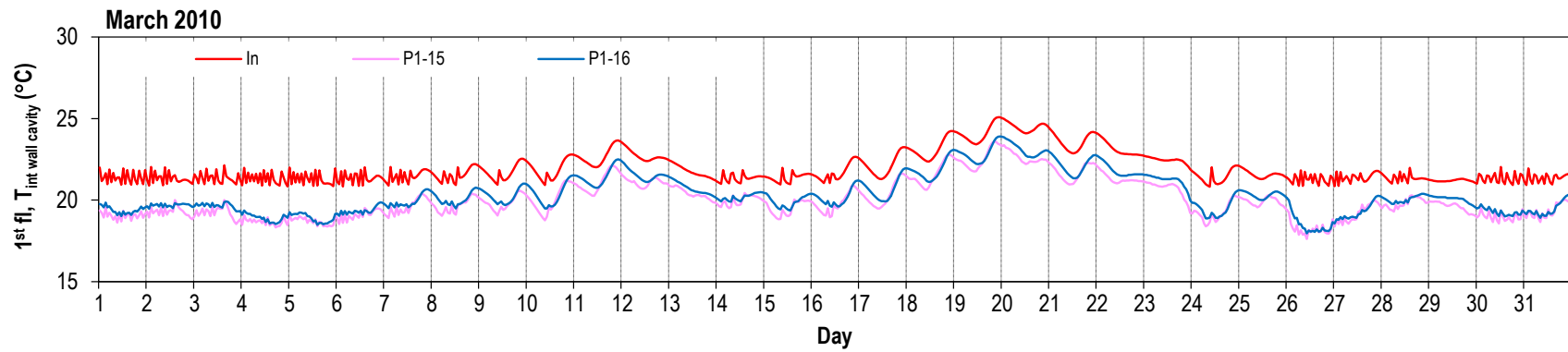

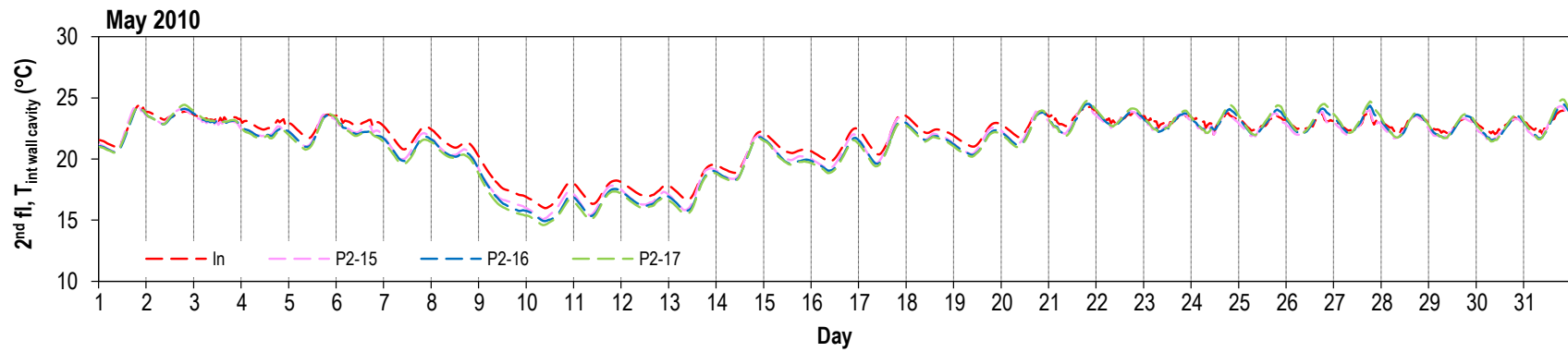
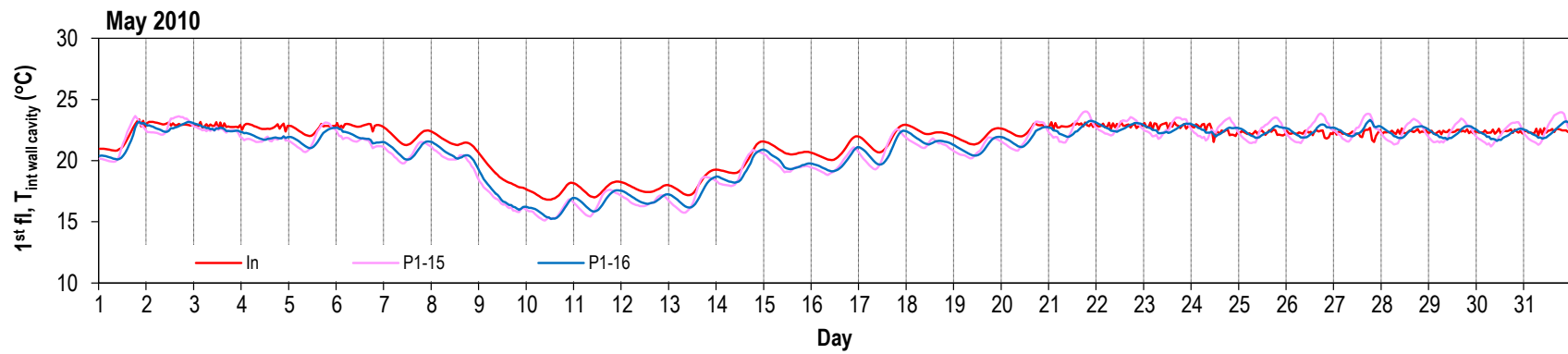
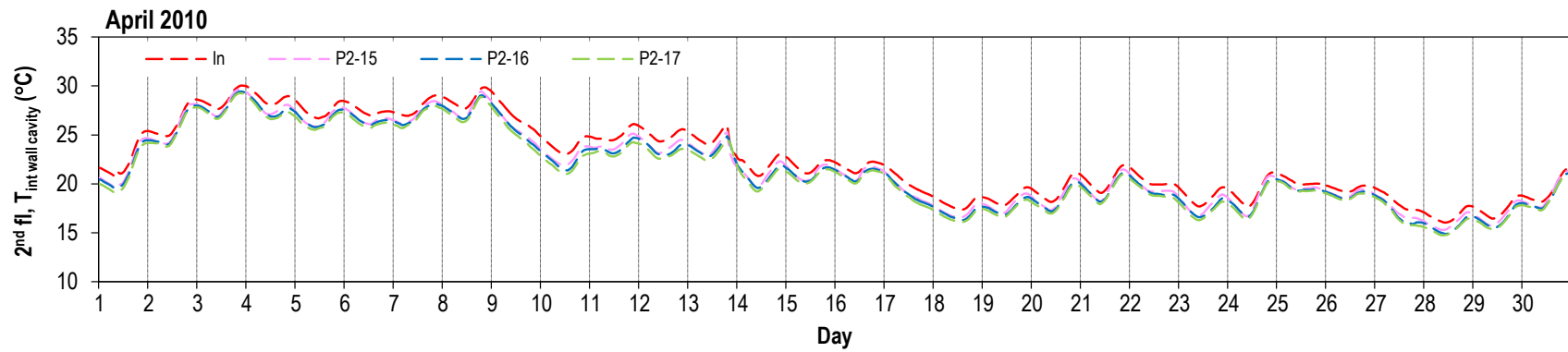

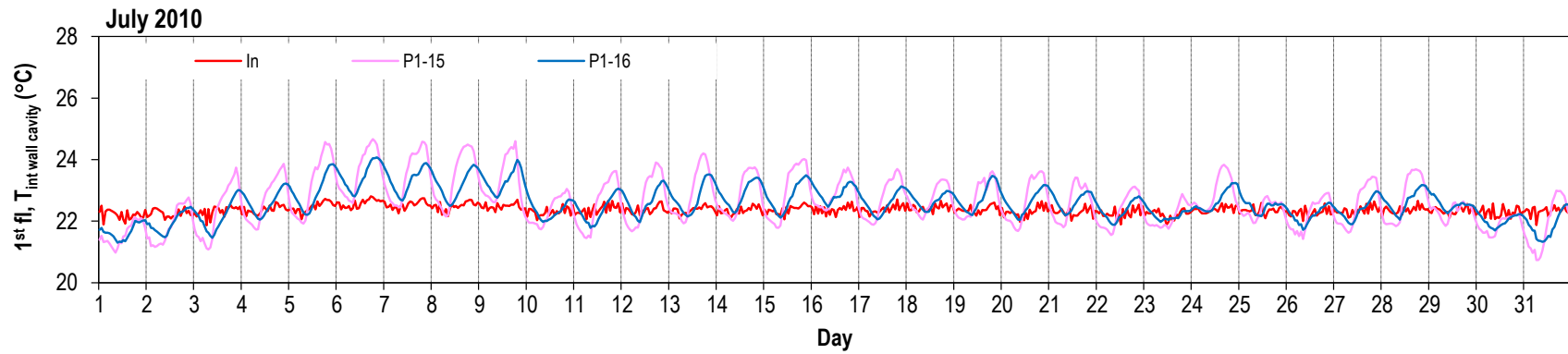
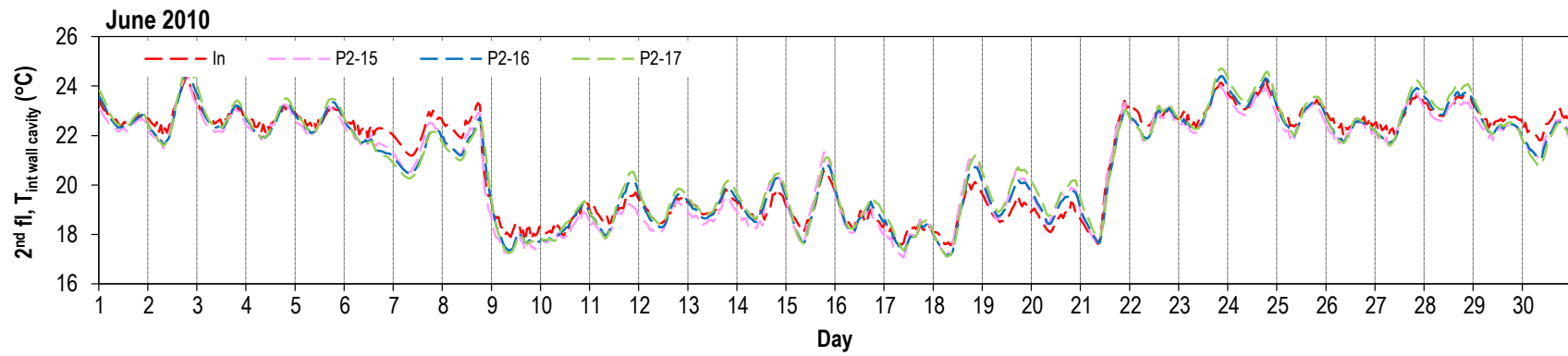
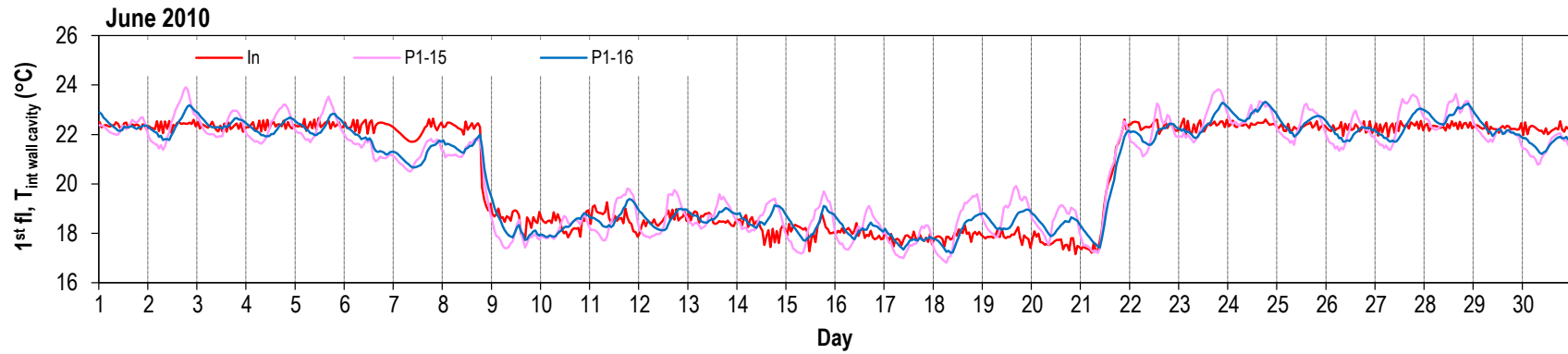

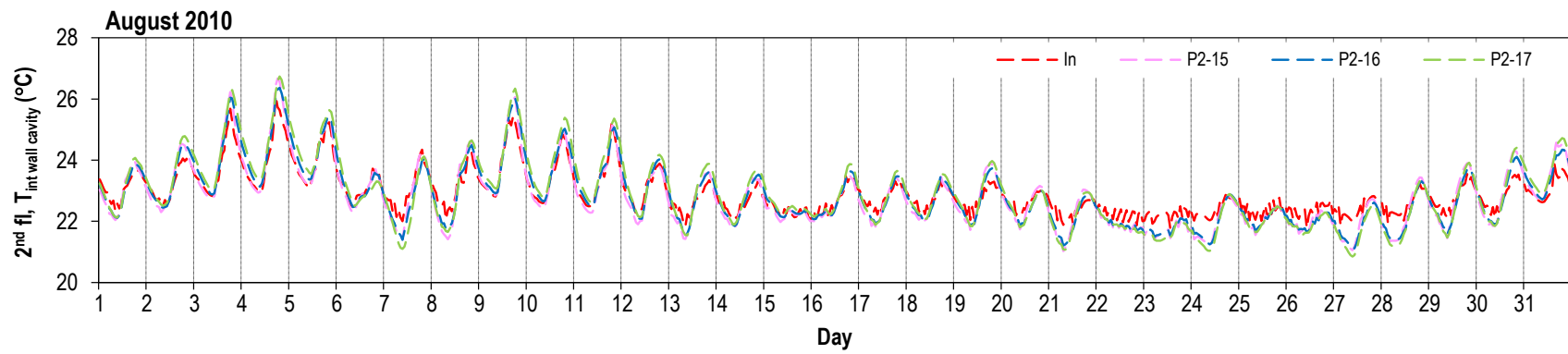
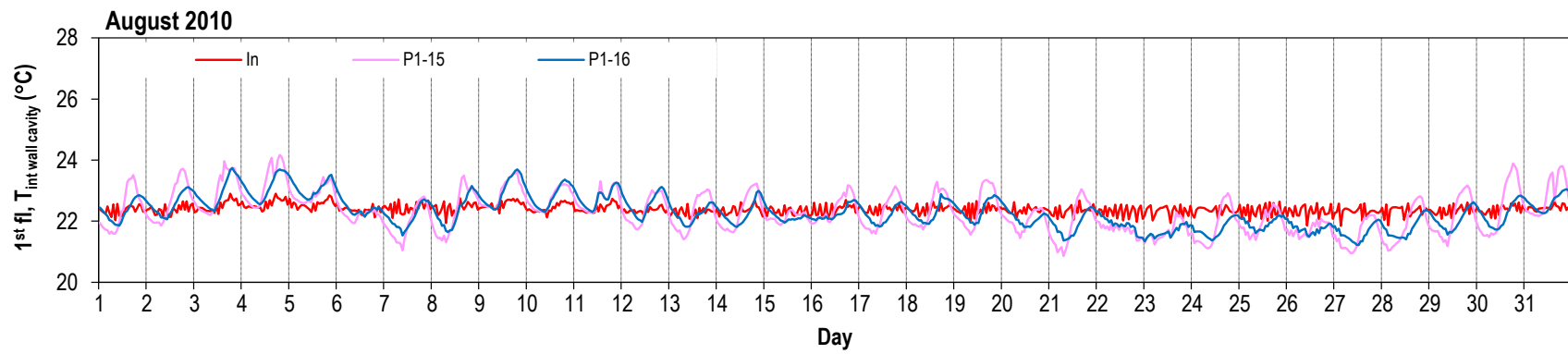
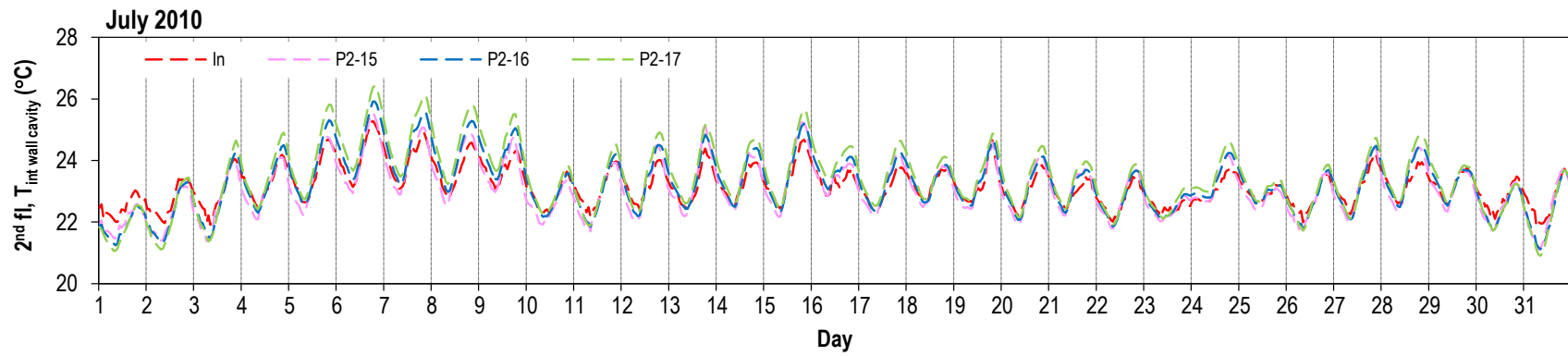

Relative humidity (%) at exterior side of stud cavity. Refer to Figures 25 thru 28 for sensor location.

Data from panel P2-15 is not shown because of equipment malfunction.

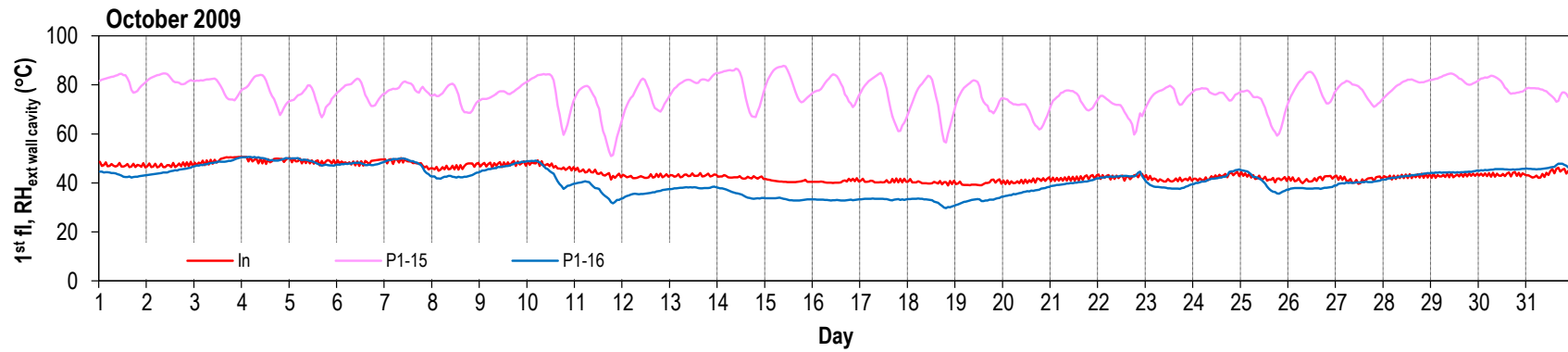
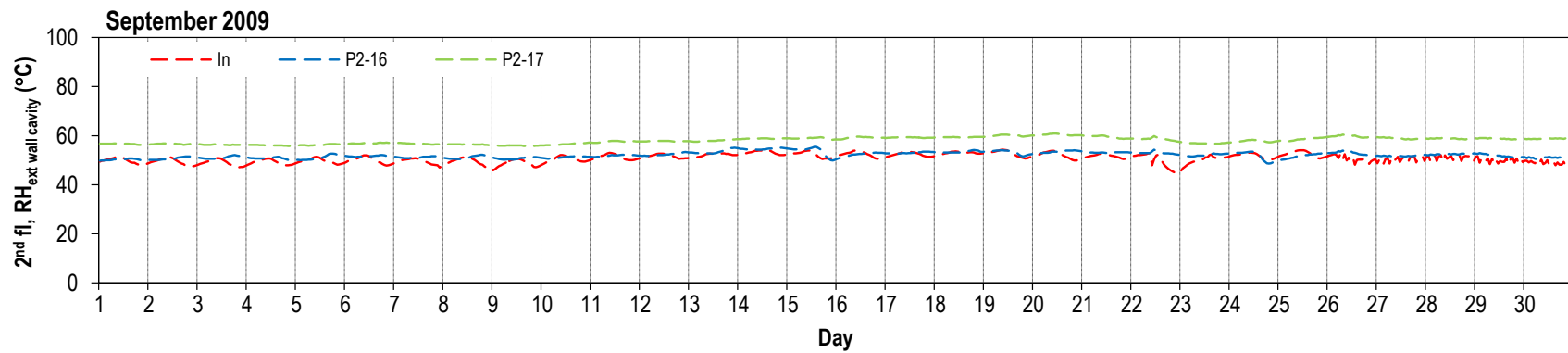
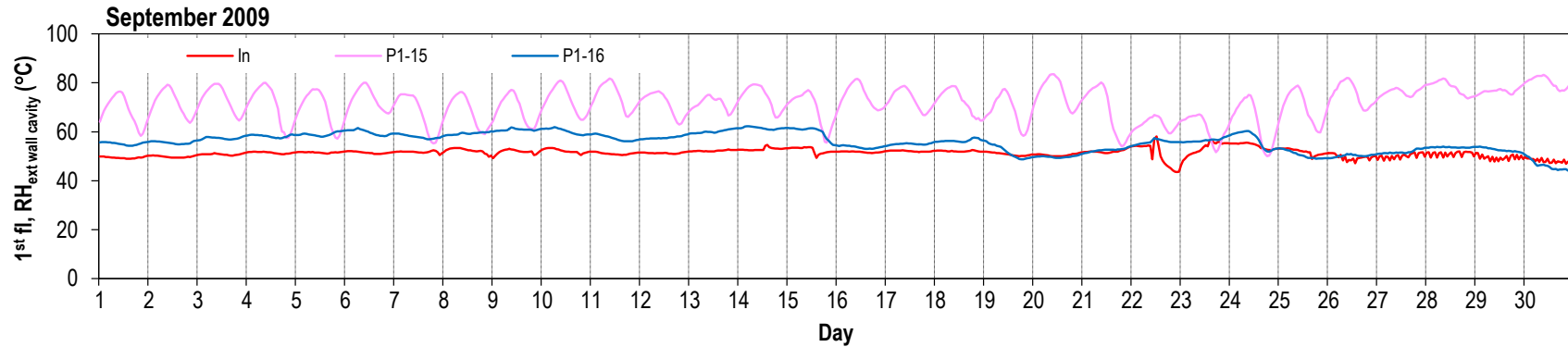

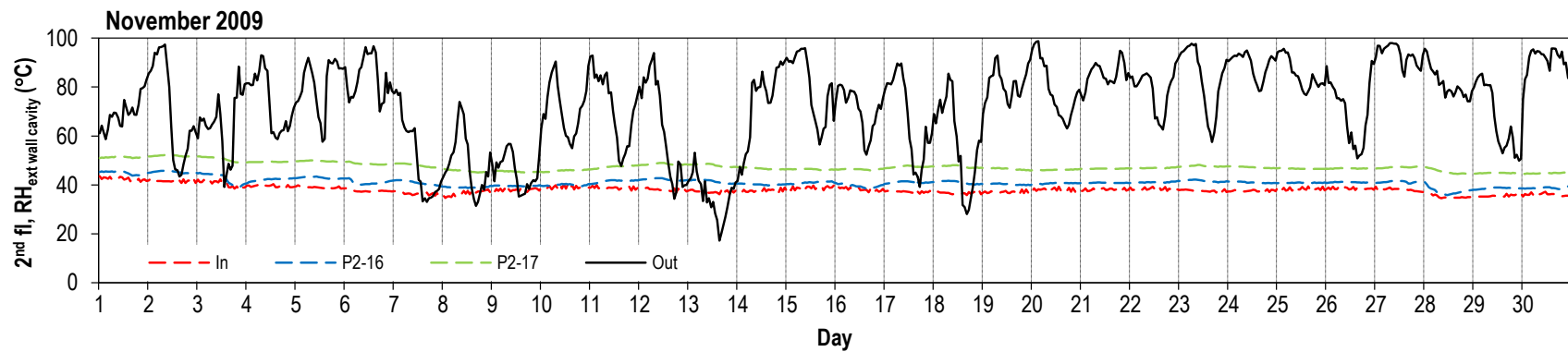
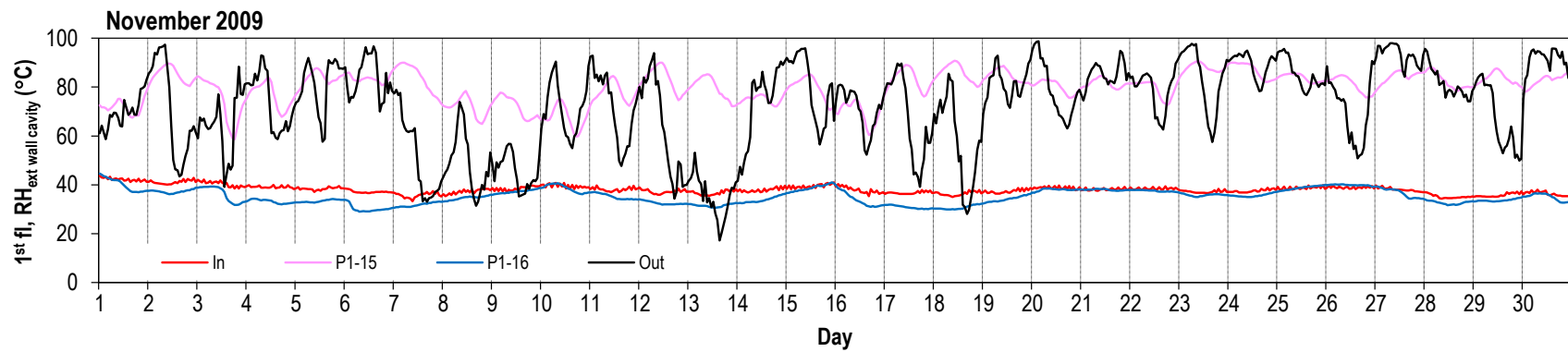
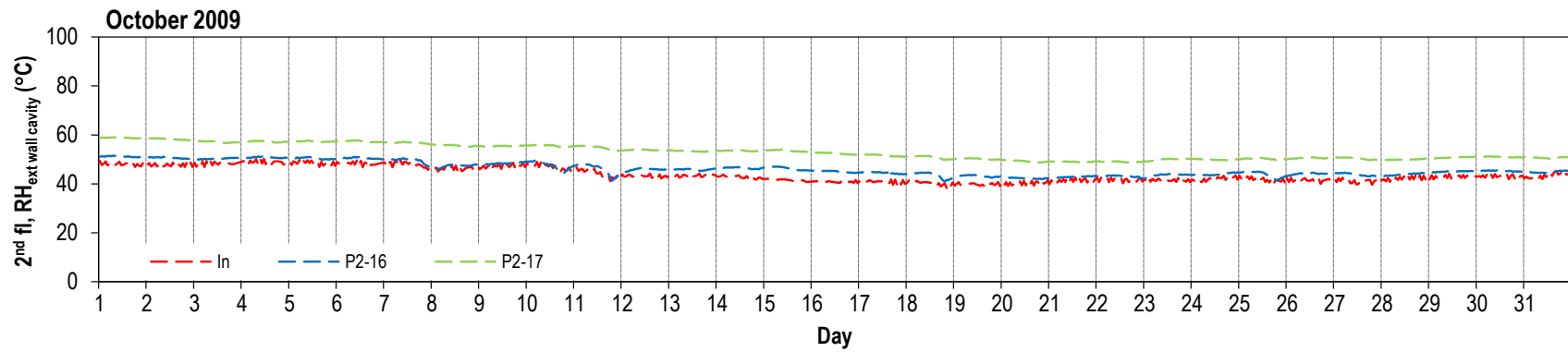

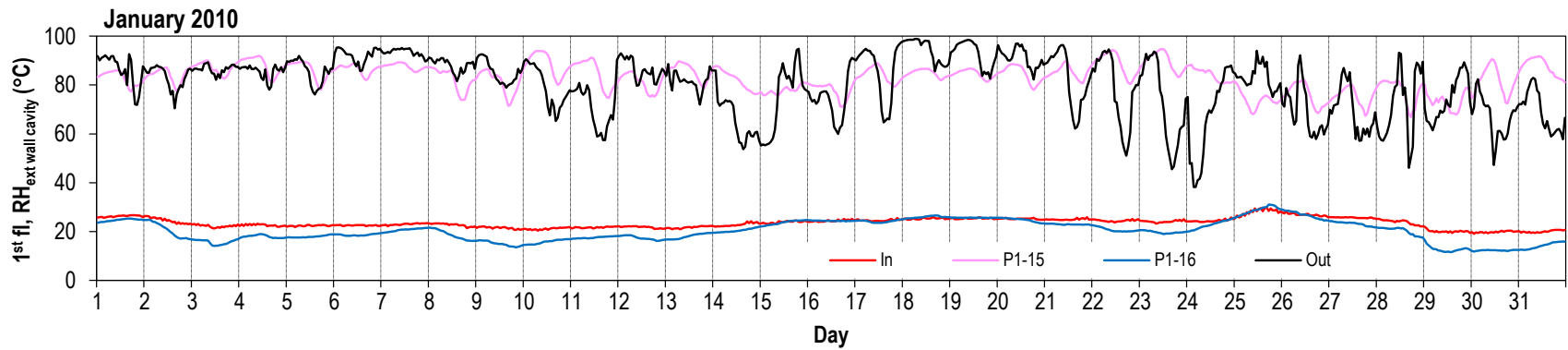
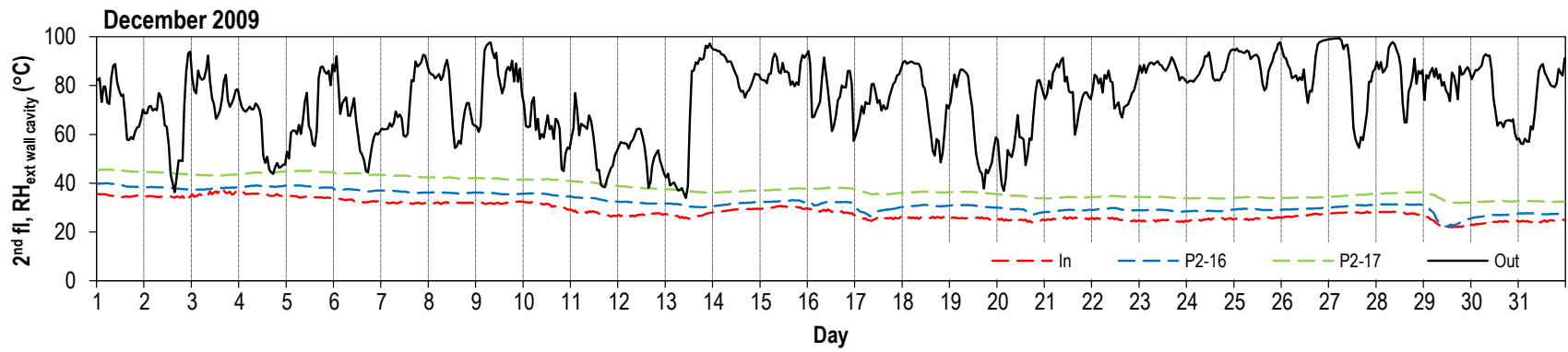
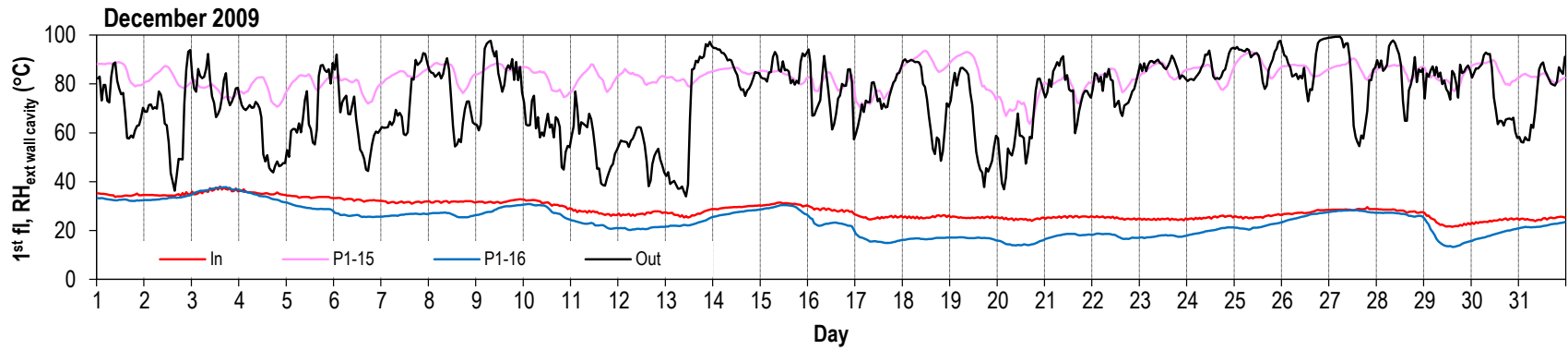

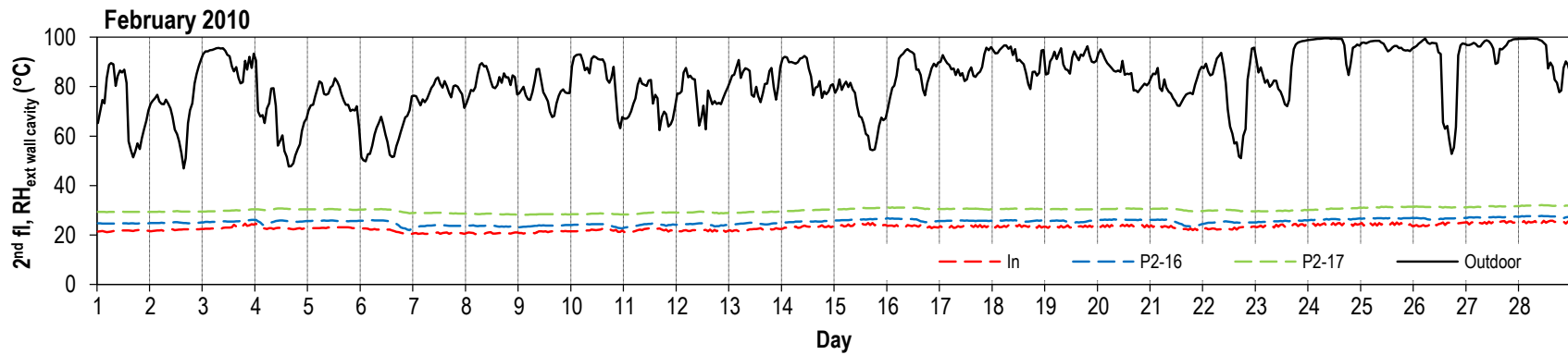
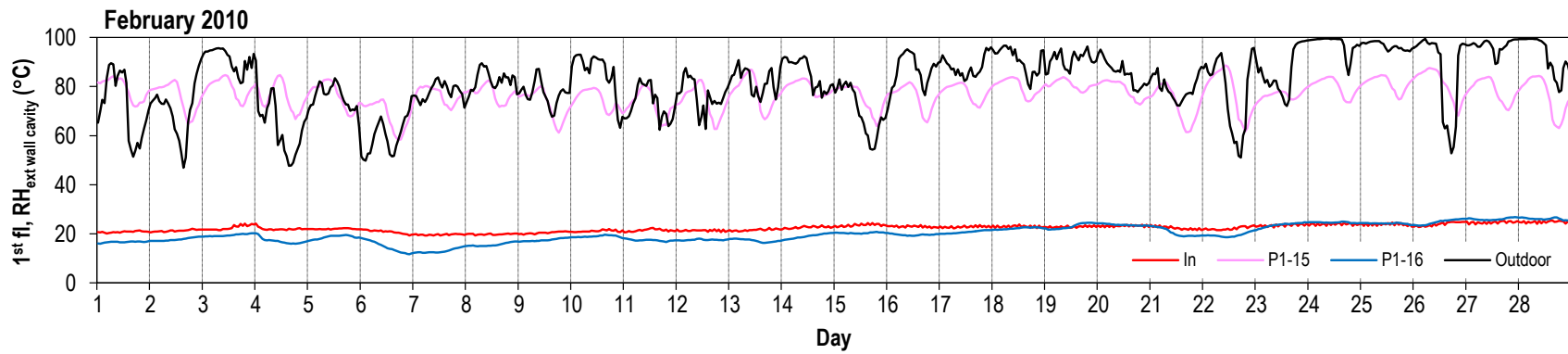
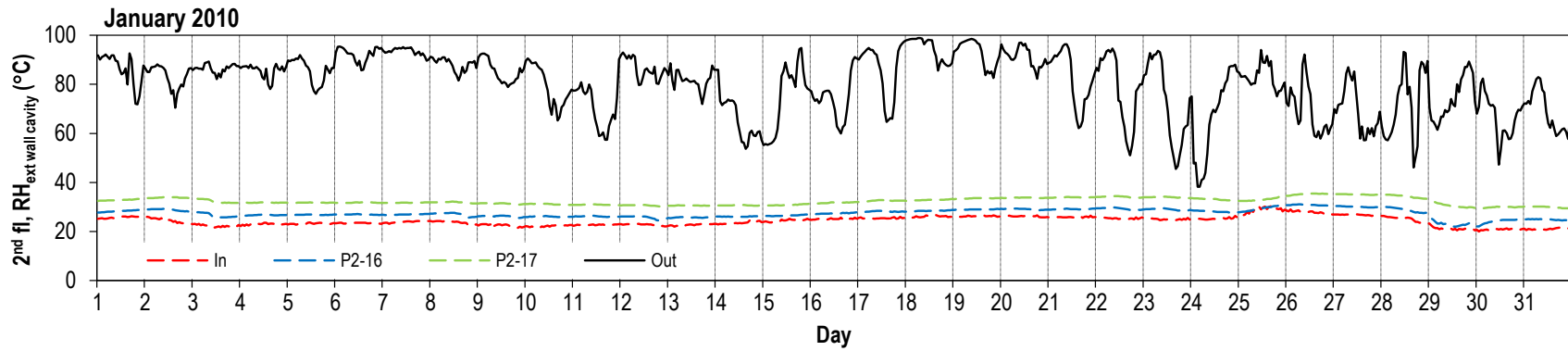

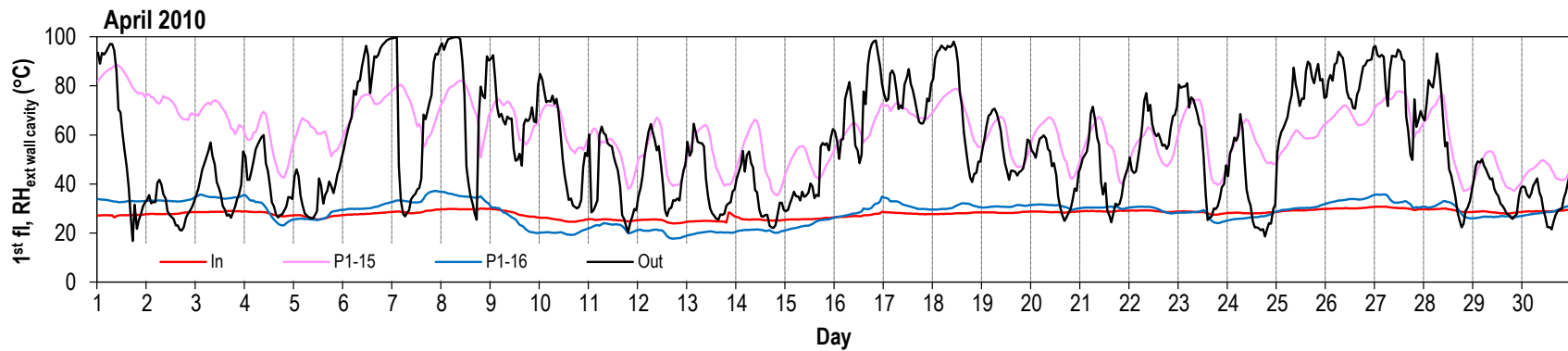
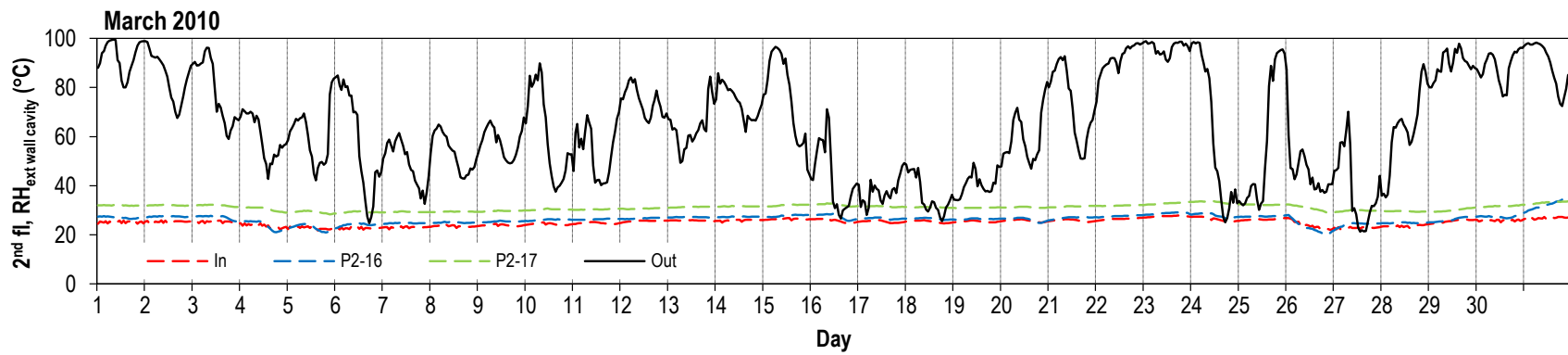
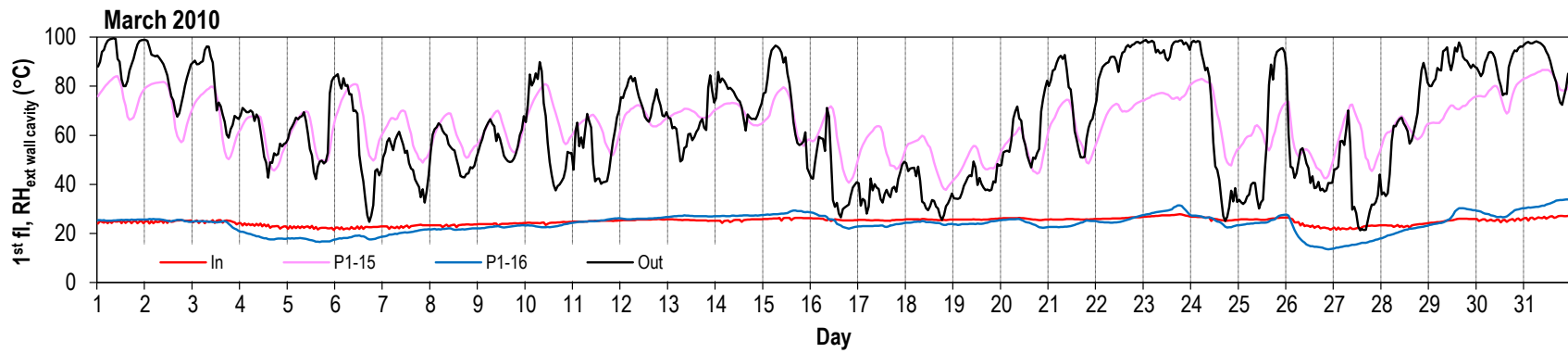

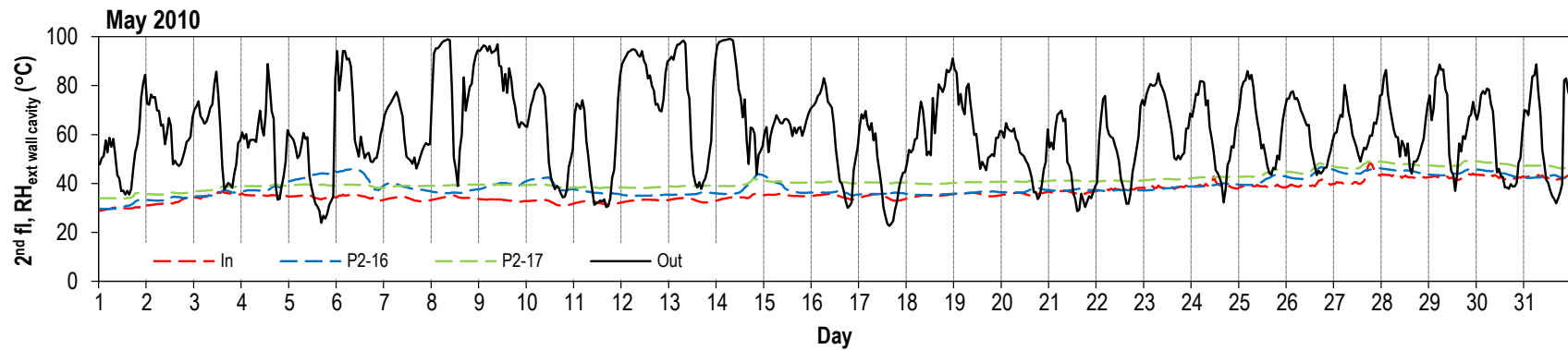
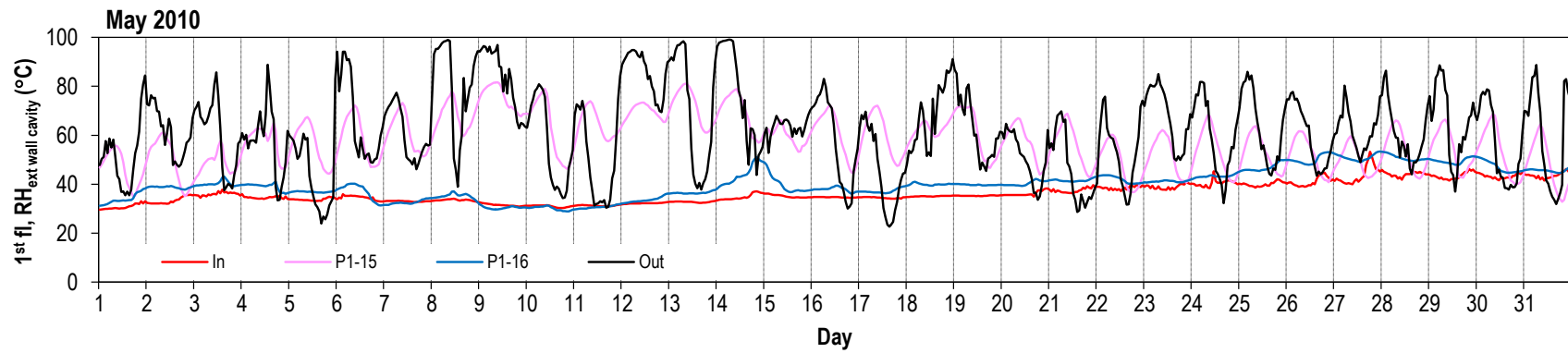
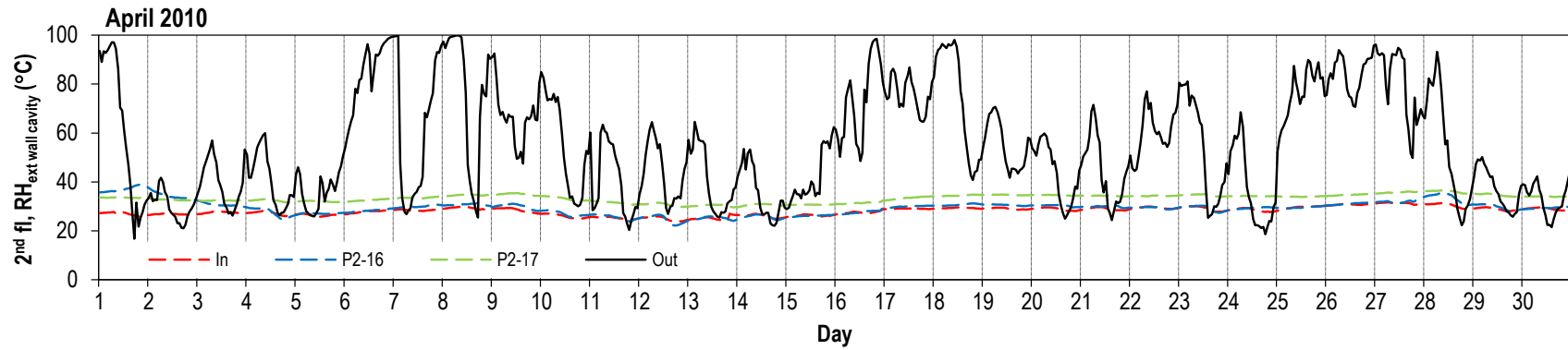

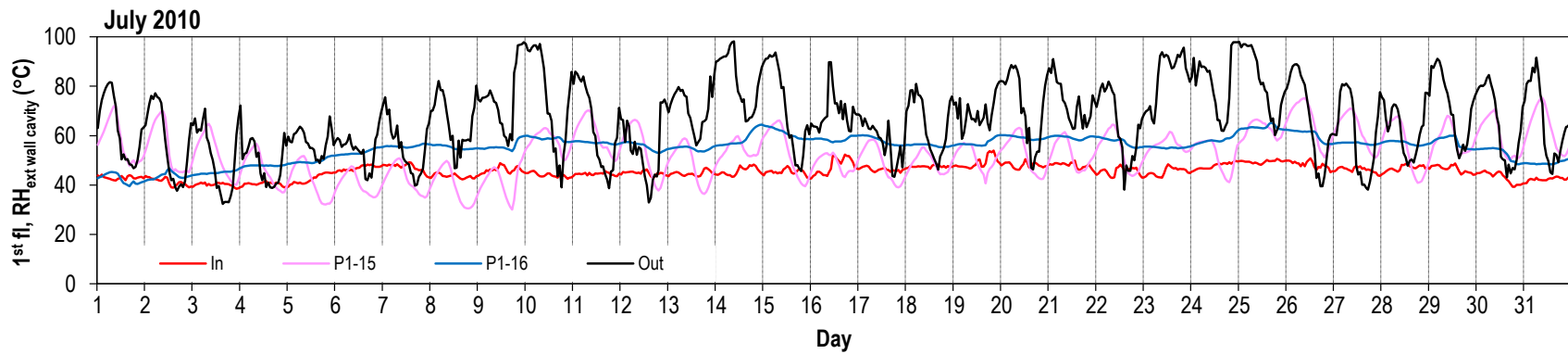
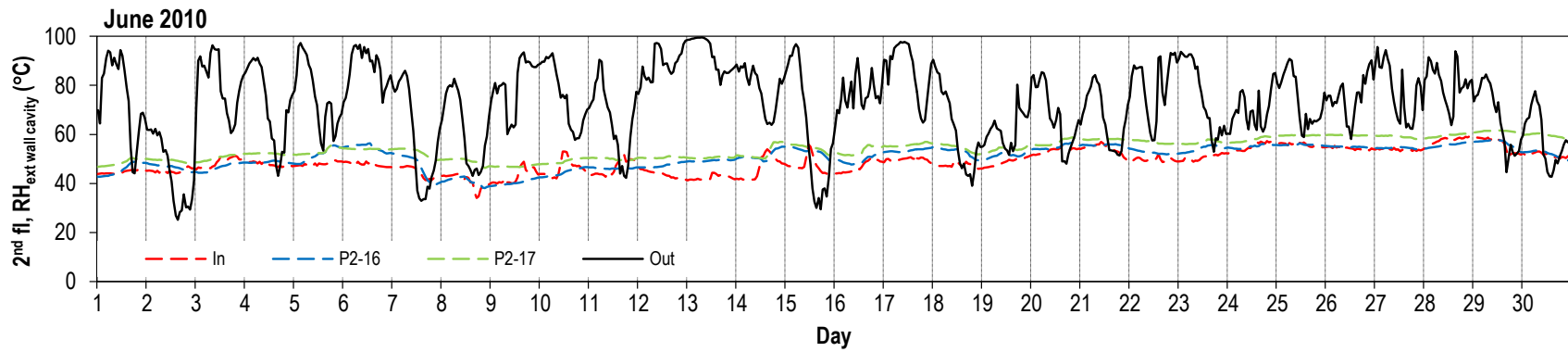
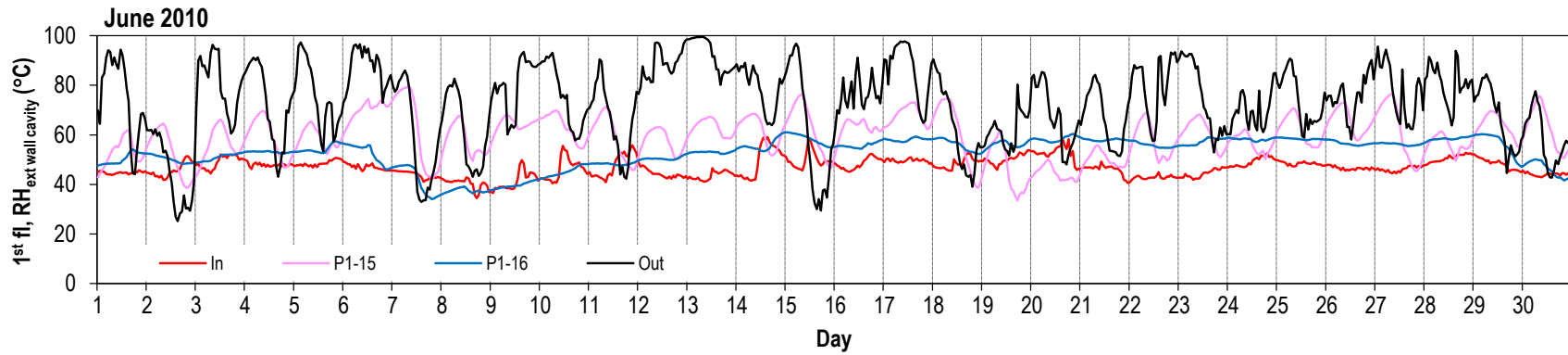

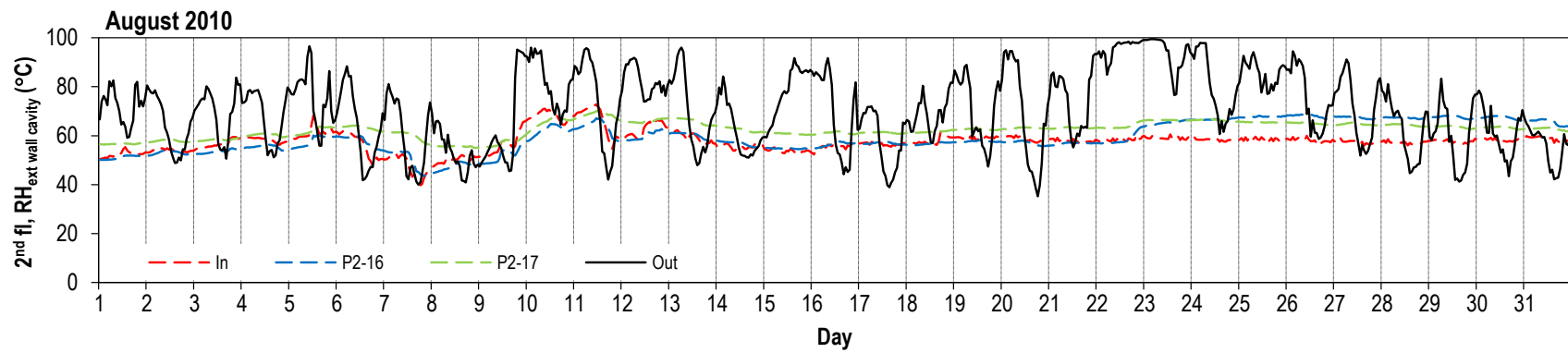
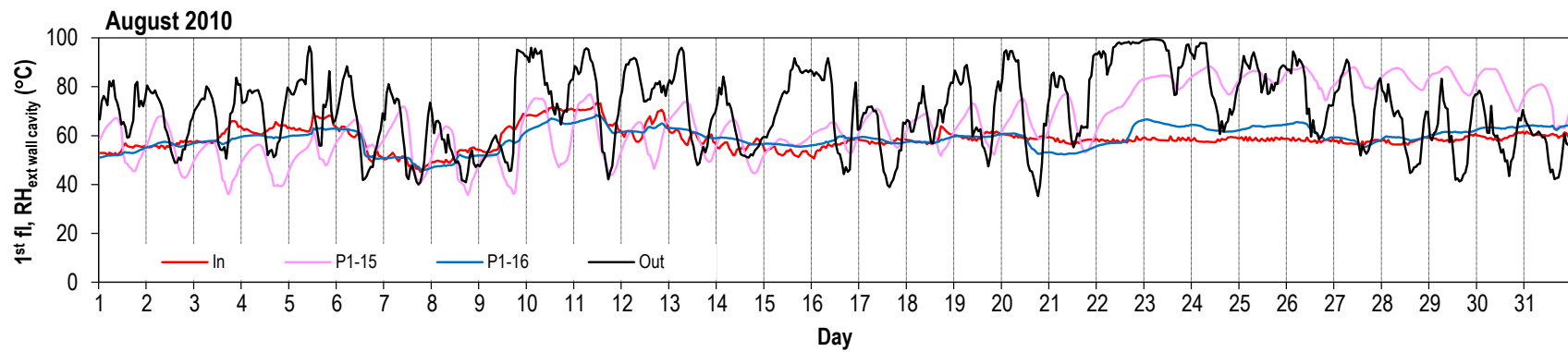
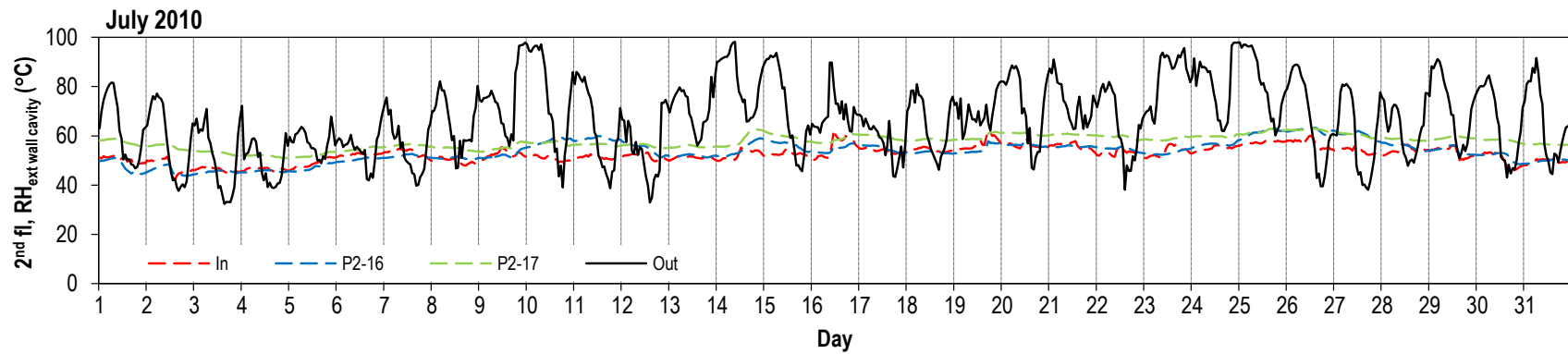

Water vapor pressure (kPa) at exterior side of stud cavity. Refer to Figures 25 thru 28 for sensor location.

Data from panel P2-15 is not shown because of equipment malfunction.

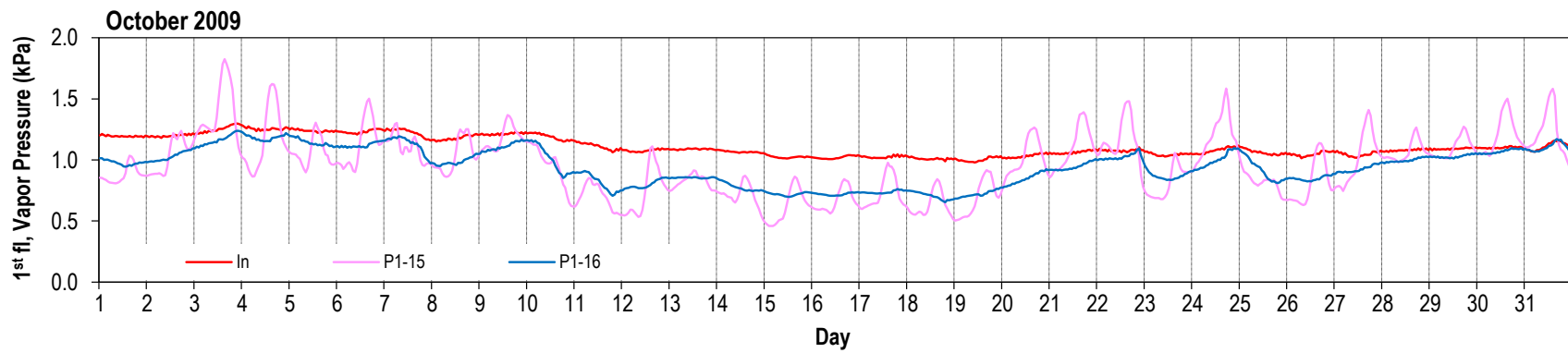
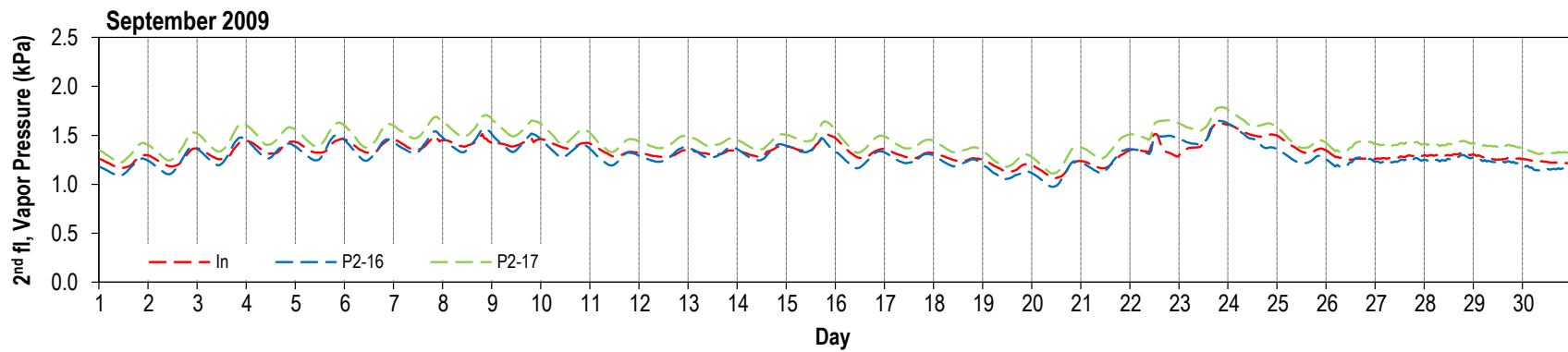
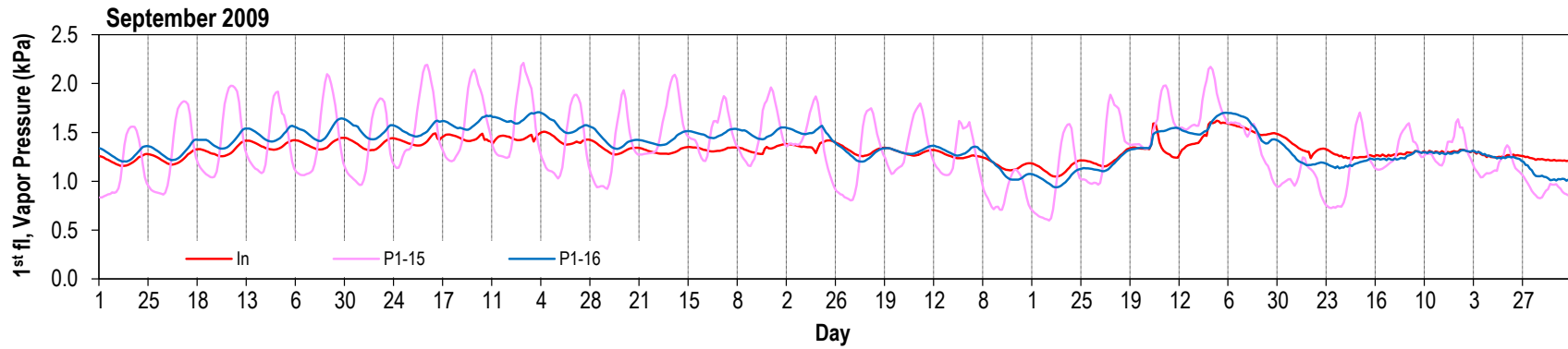

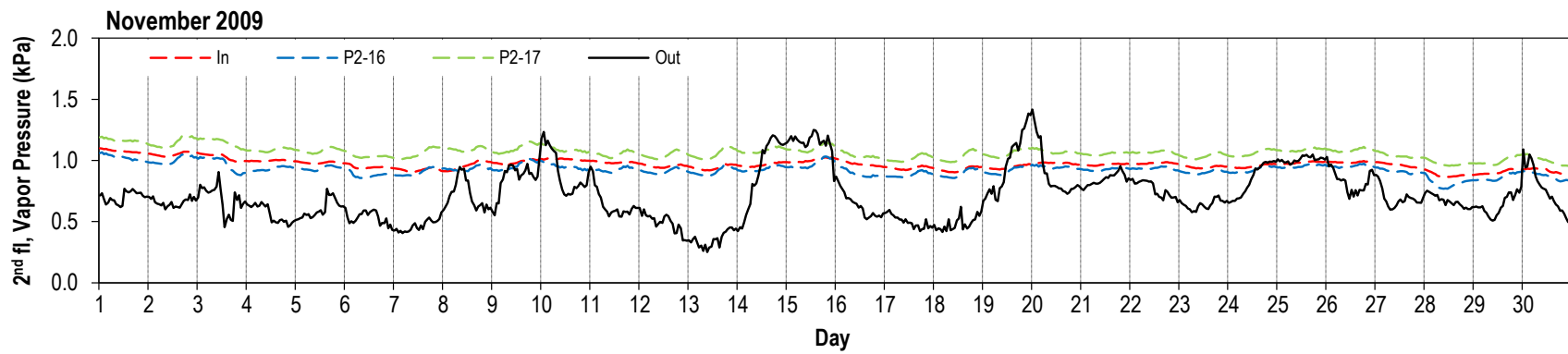
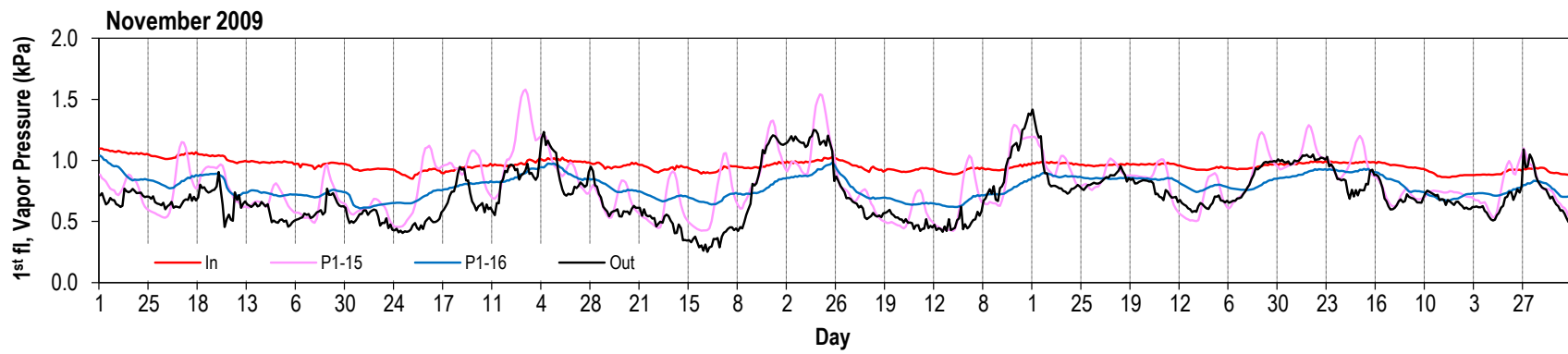
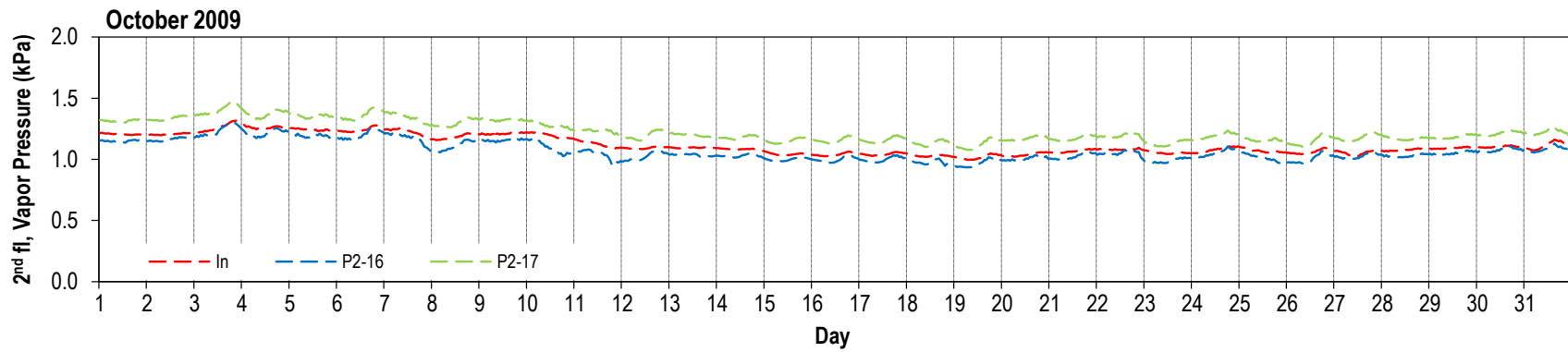

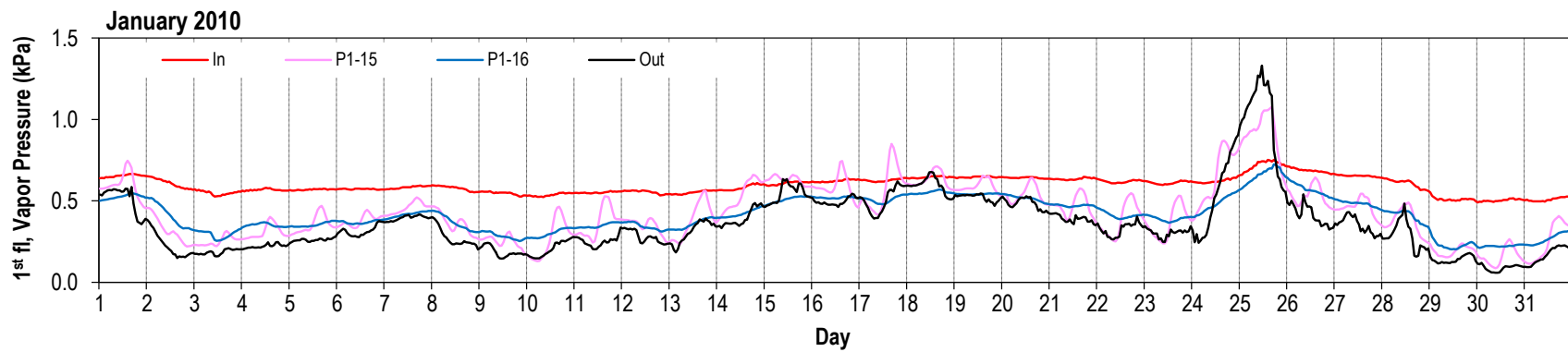
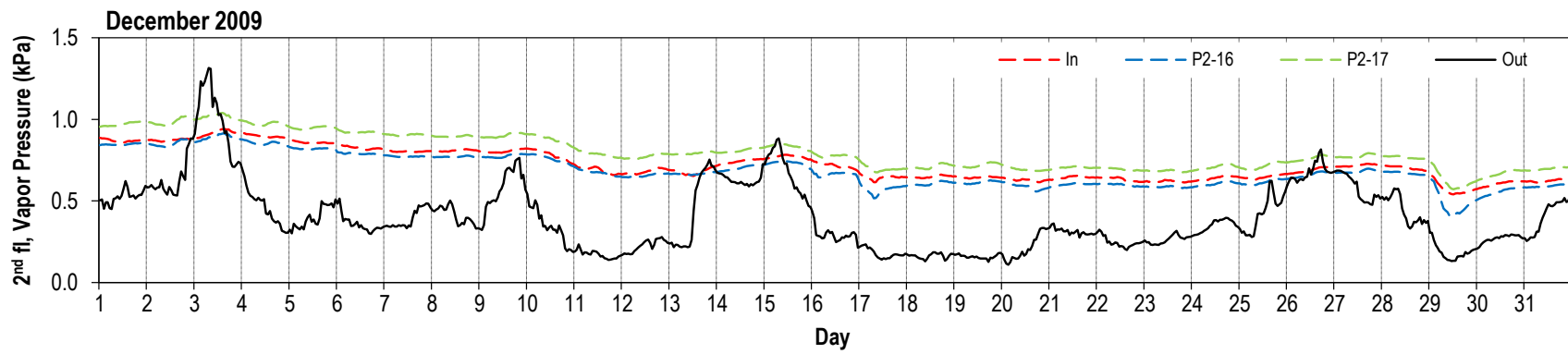
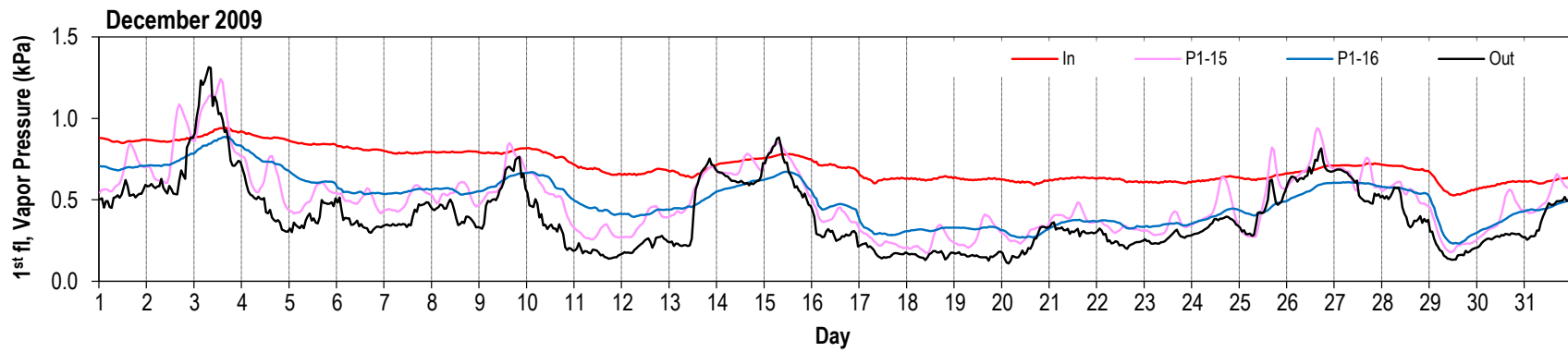

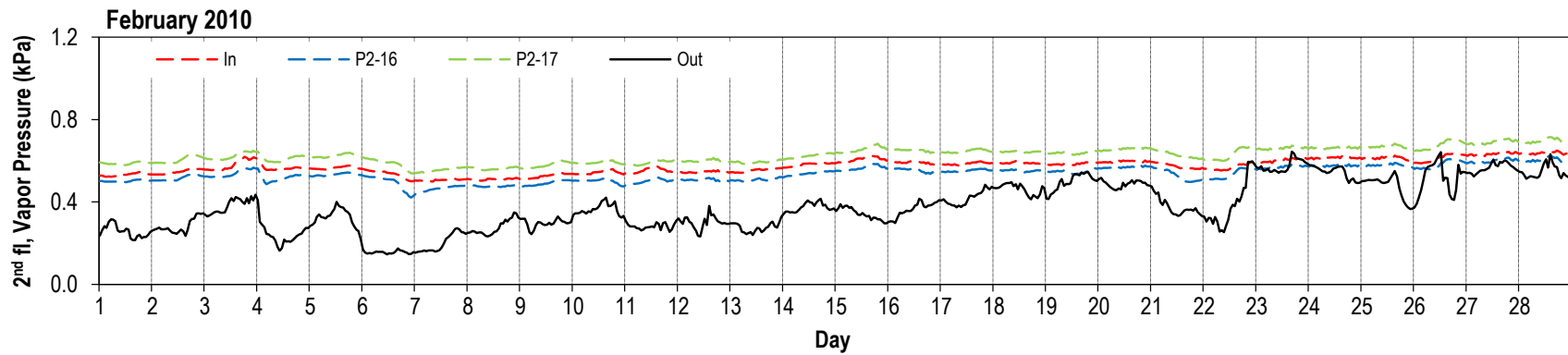
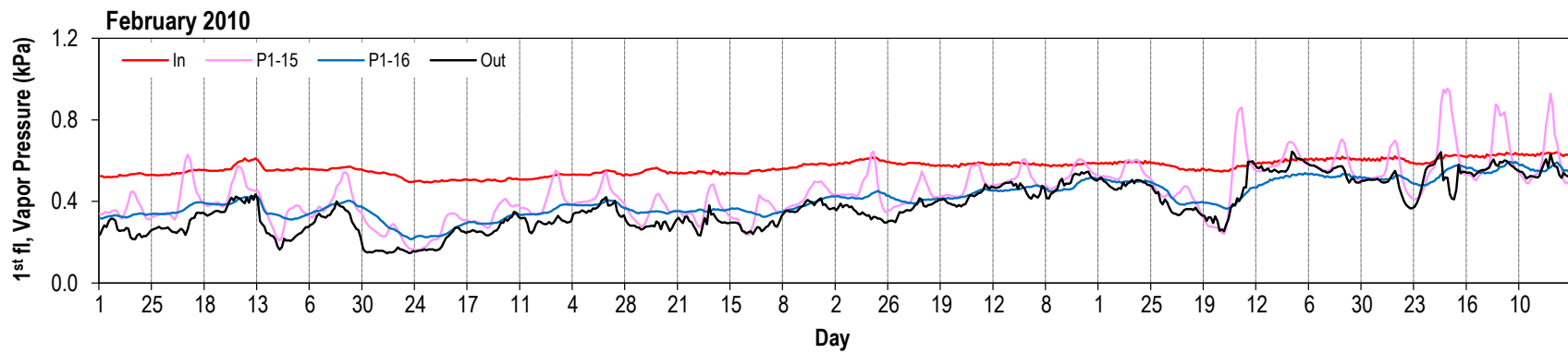
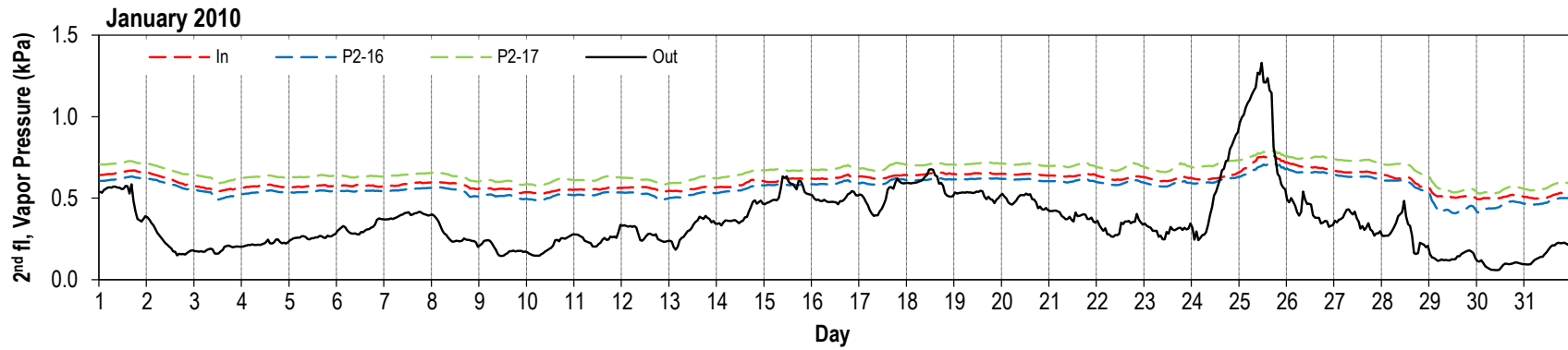

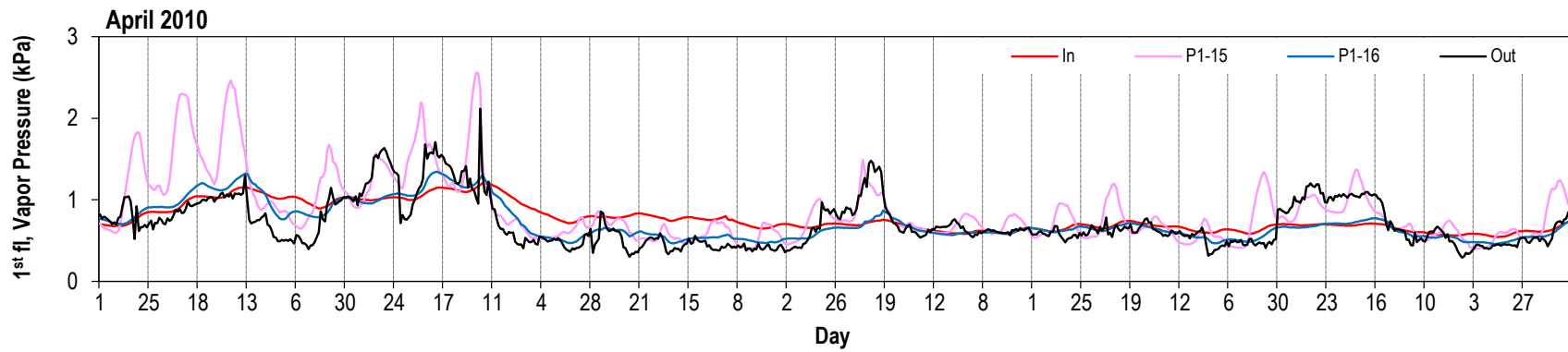
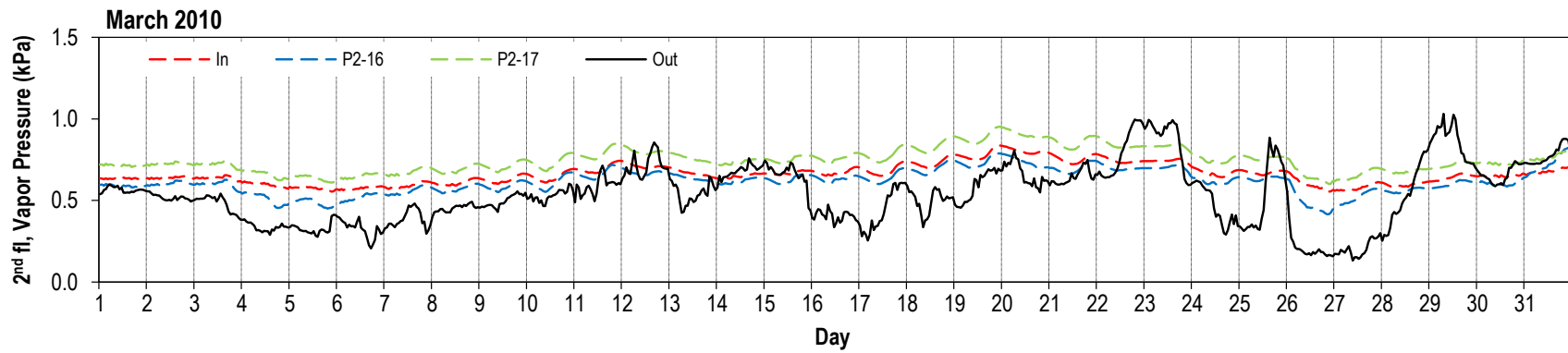
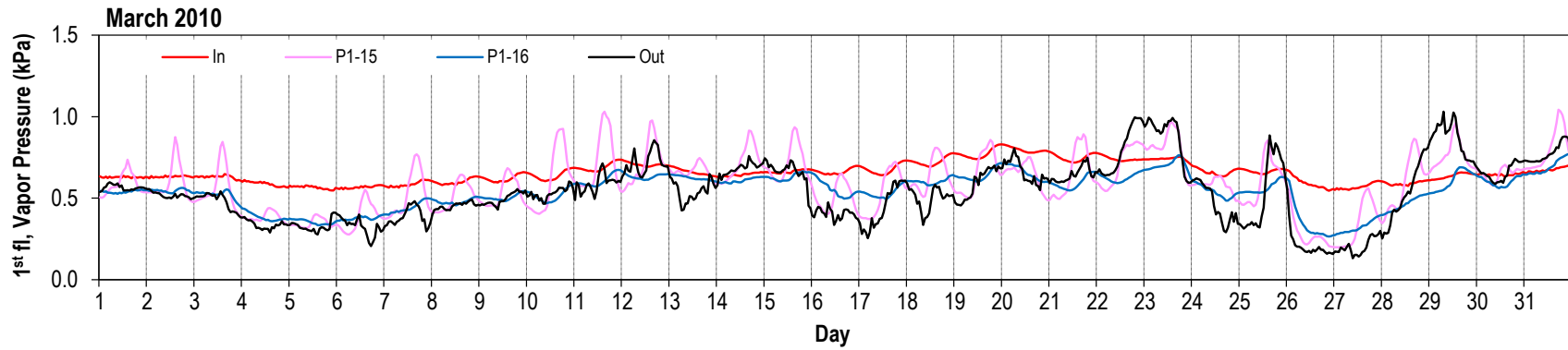

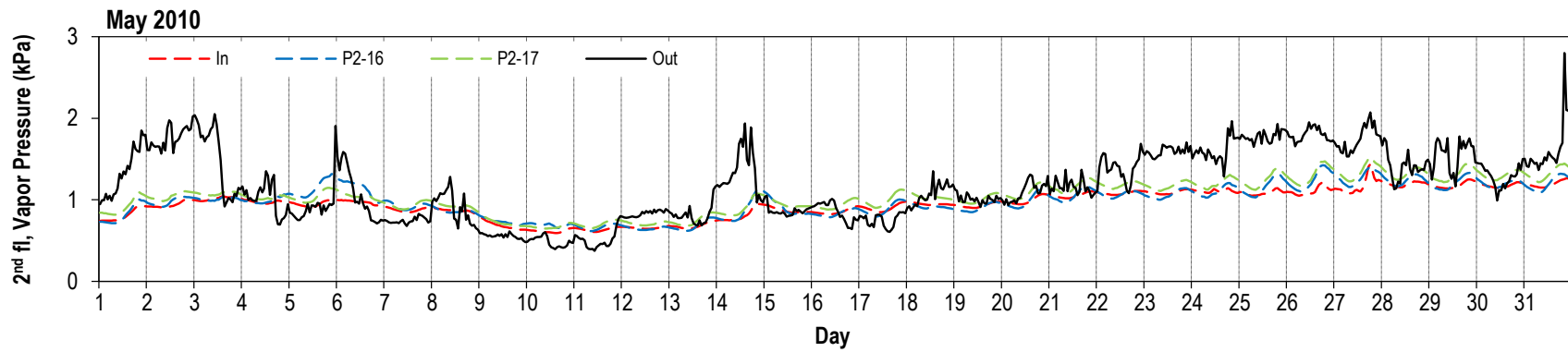
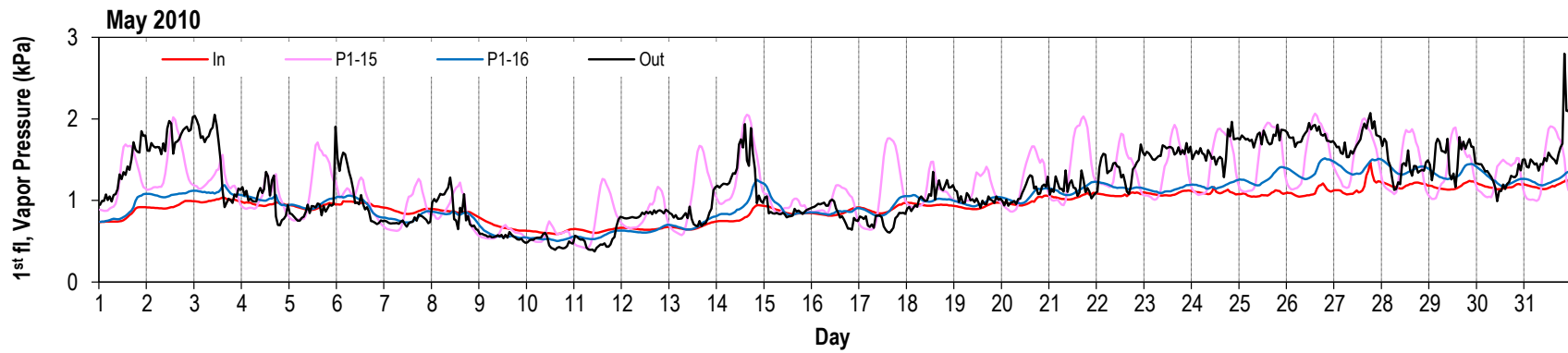
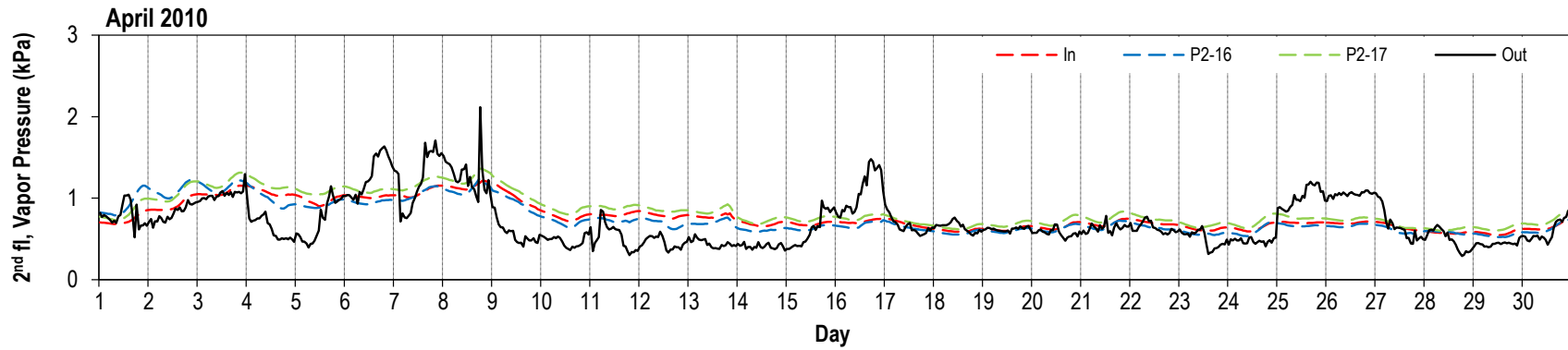

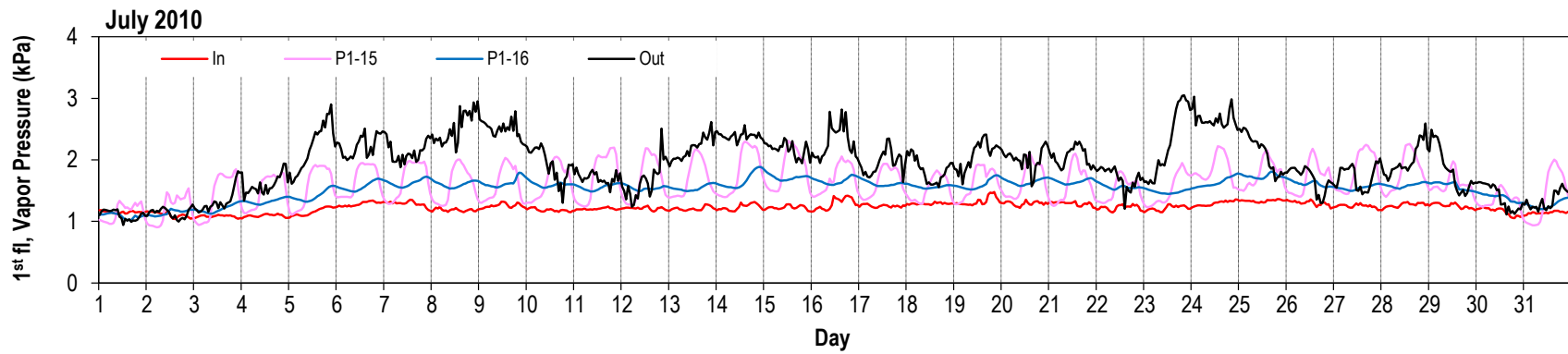
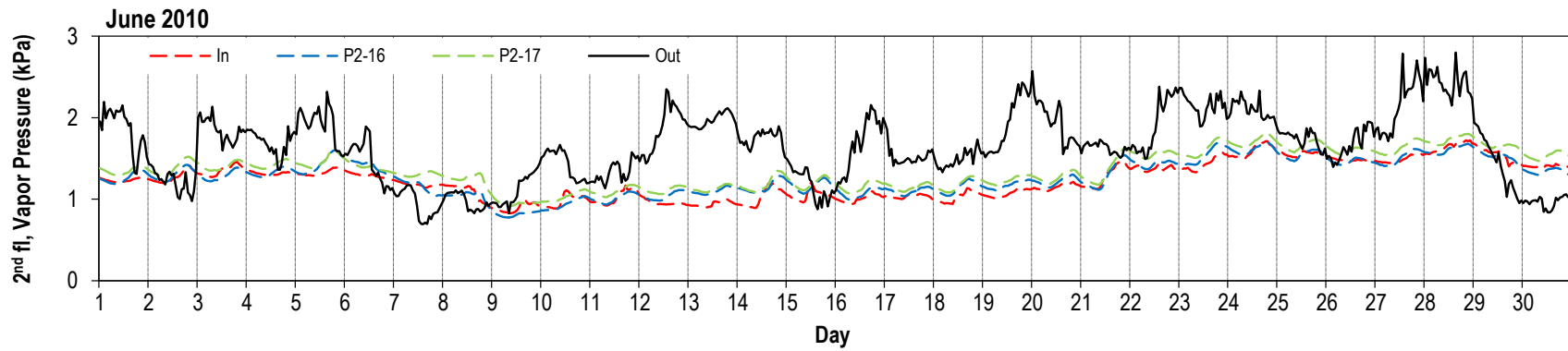
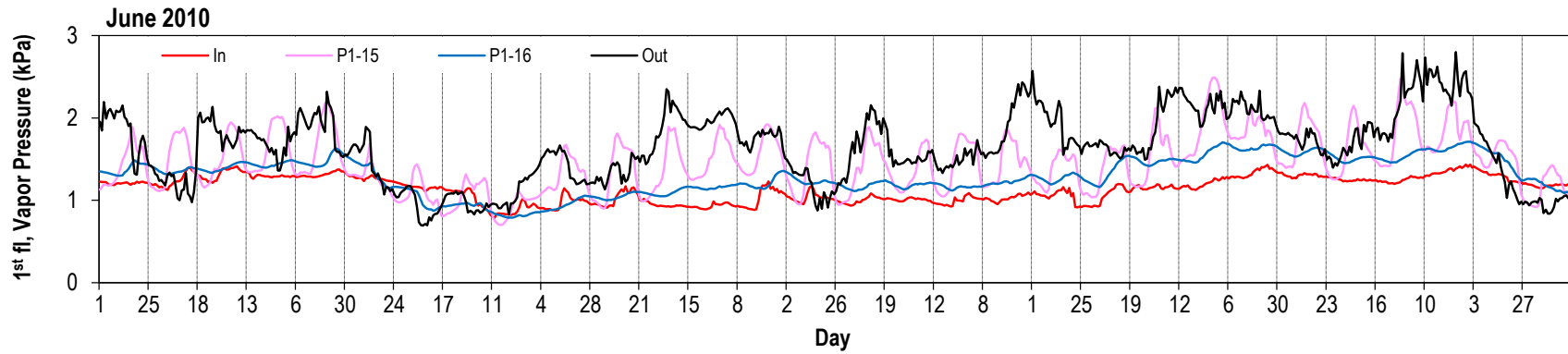

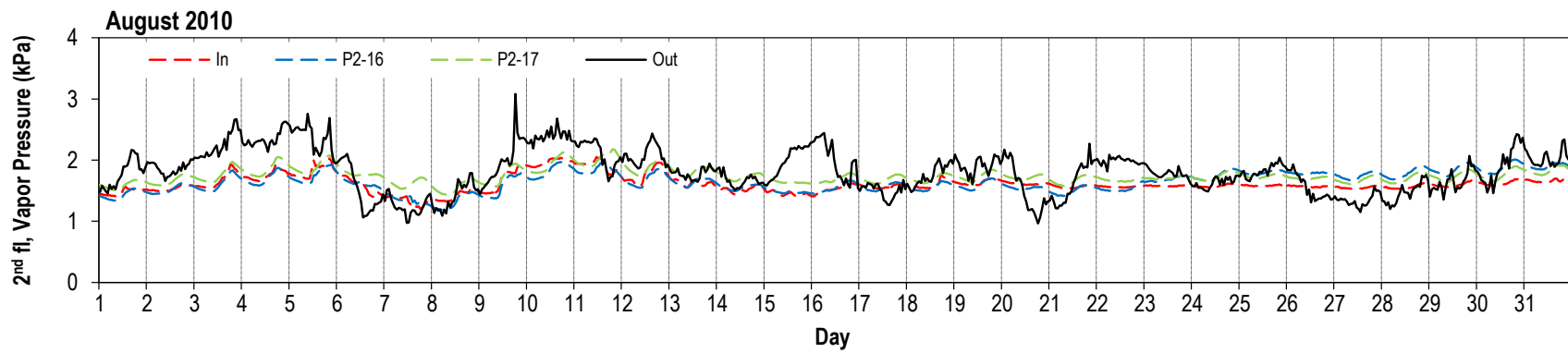
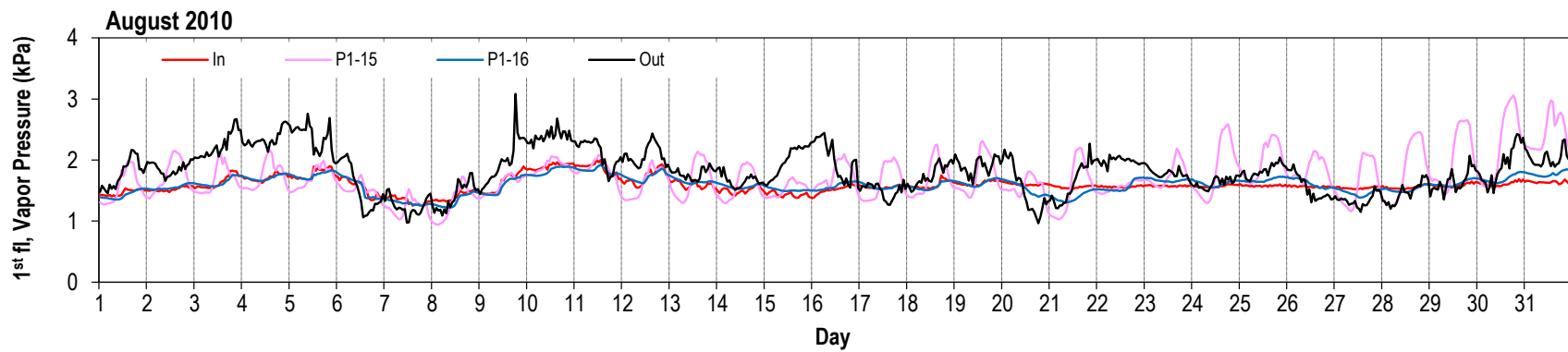
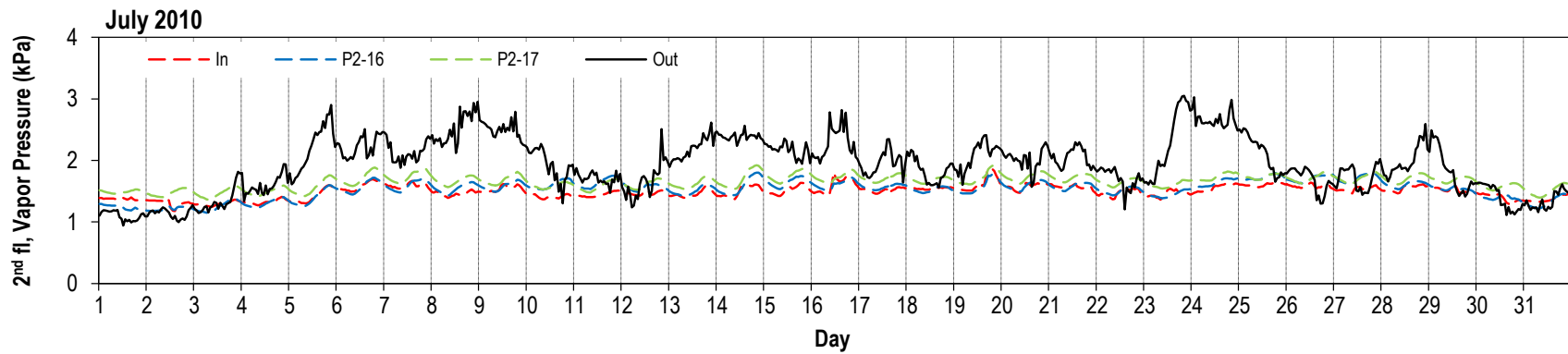

Heat flux (W/m^2) thru interior side of stud cavity. Refer to Figures 25 thru 28 for sensor location.

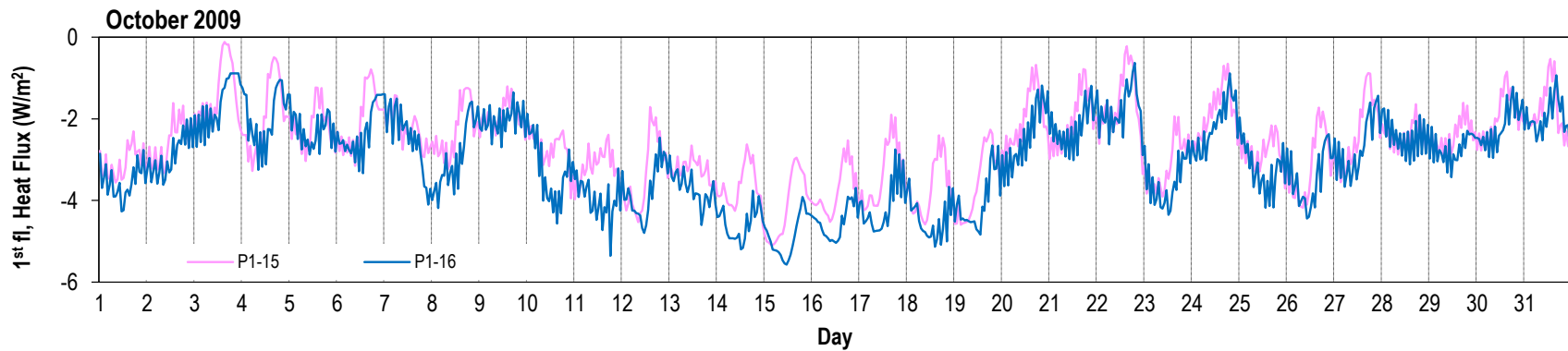
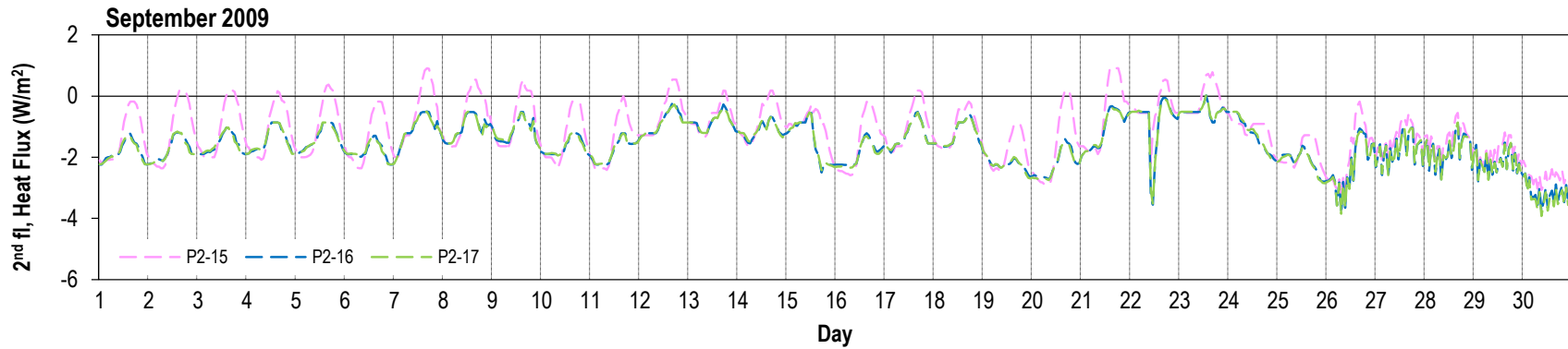
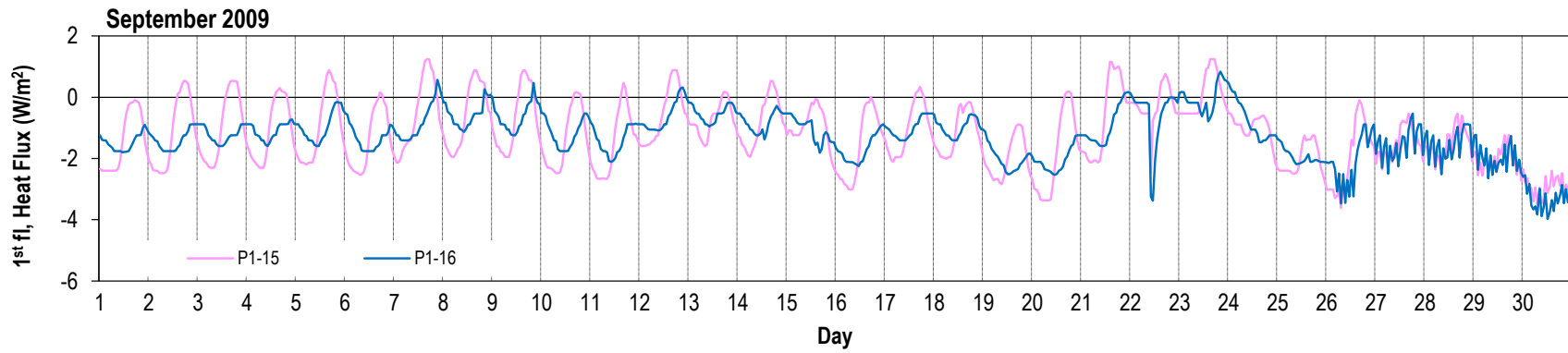

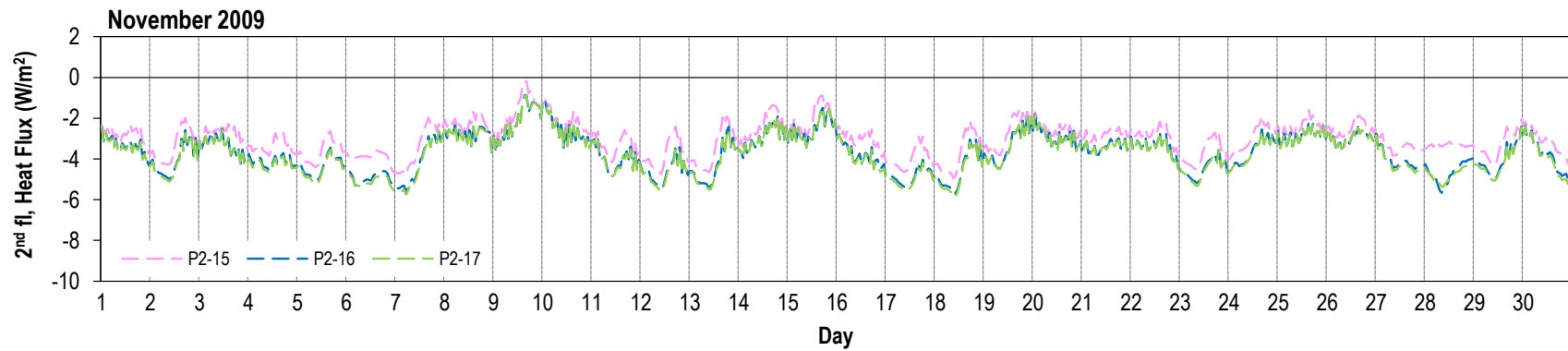
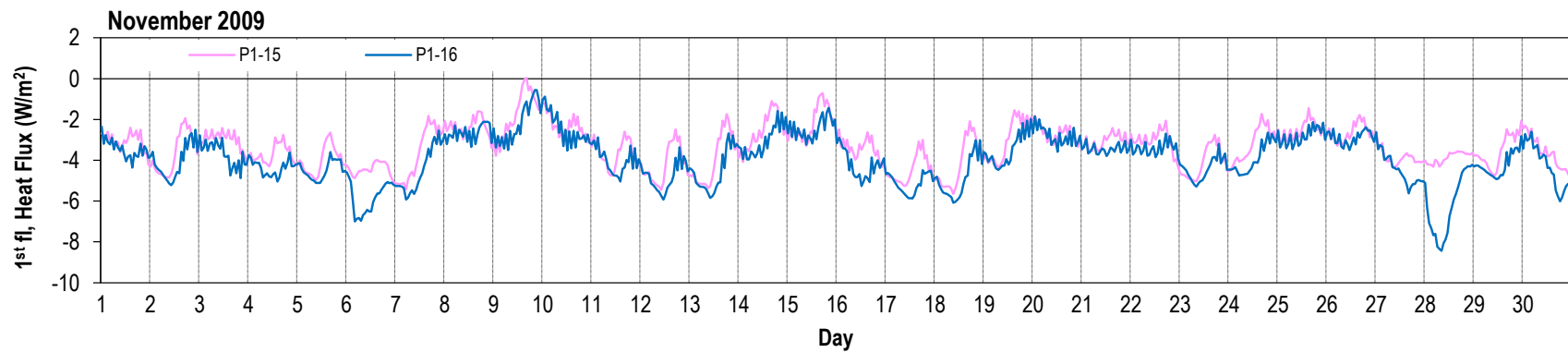
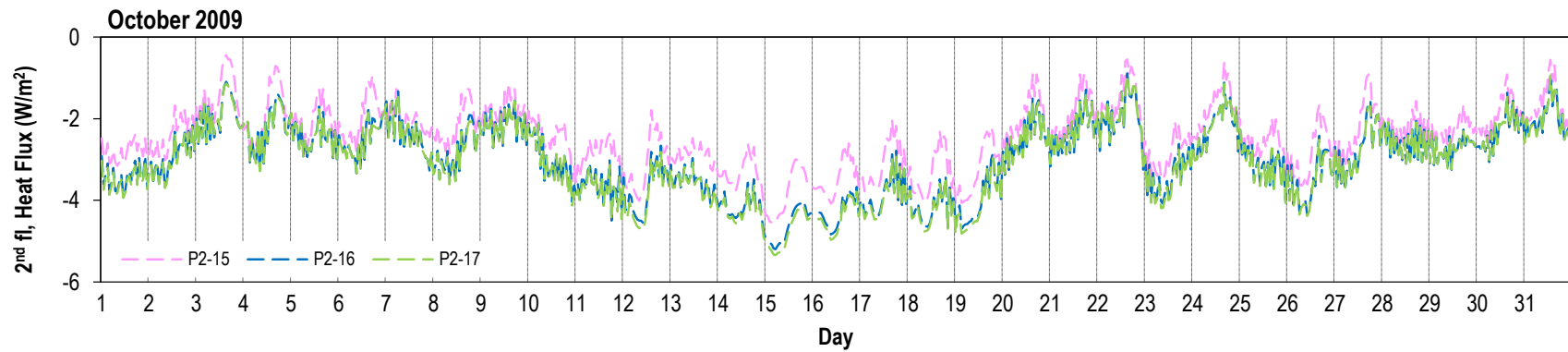

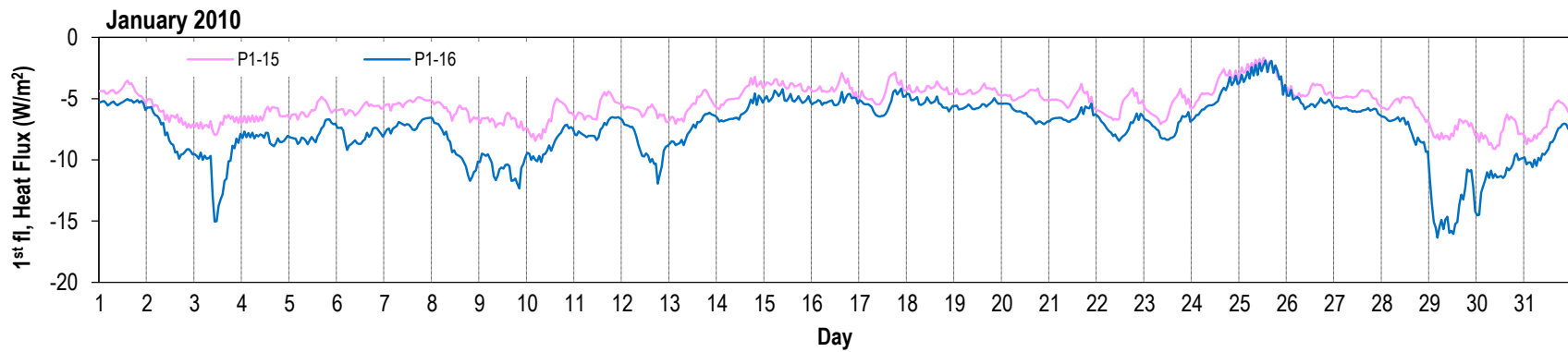
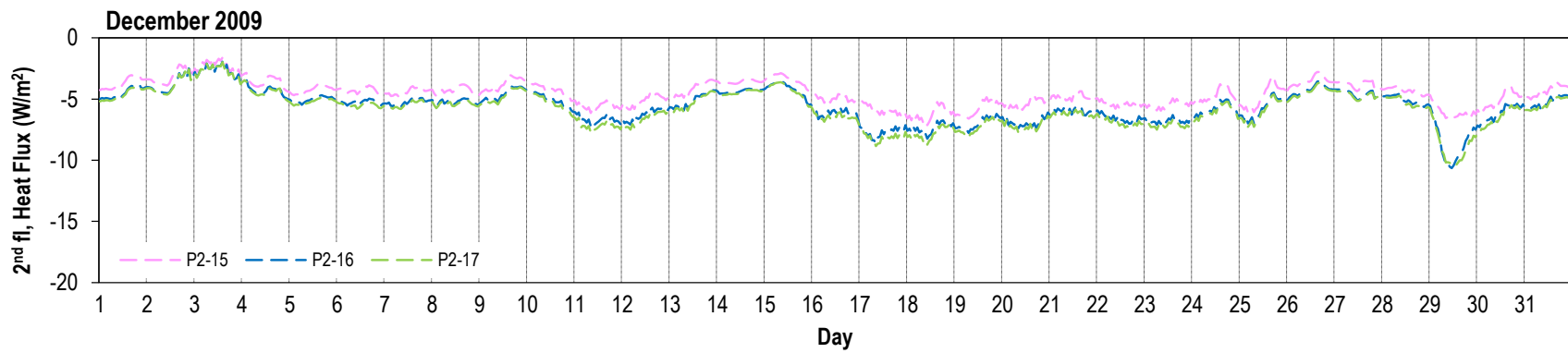
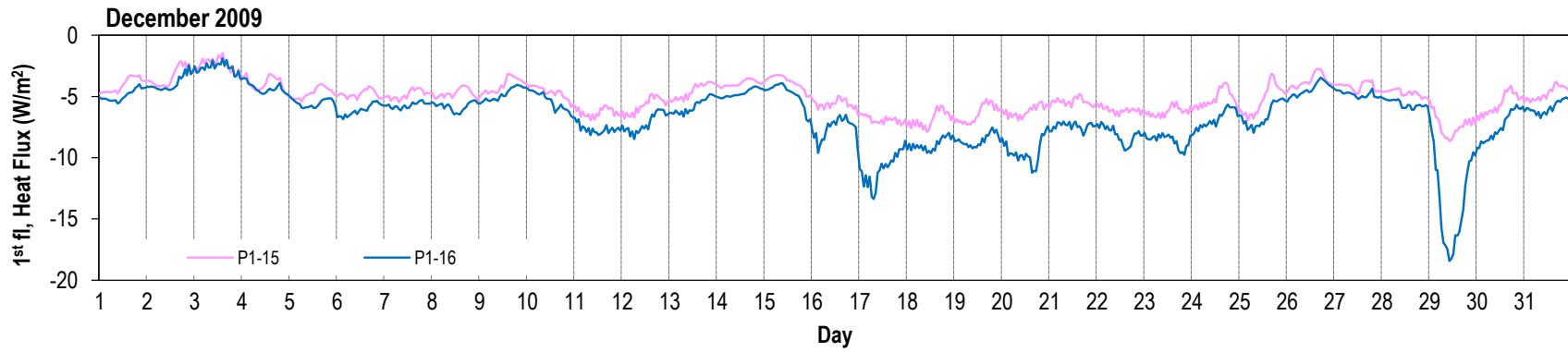

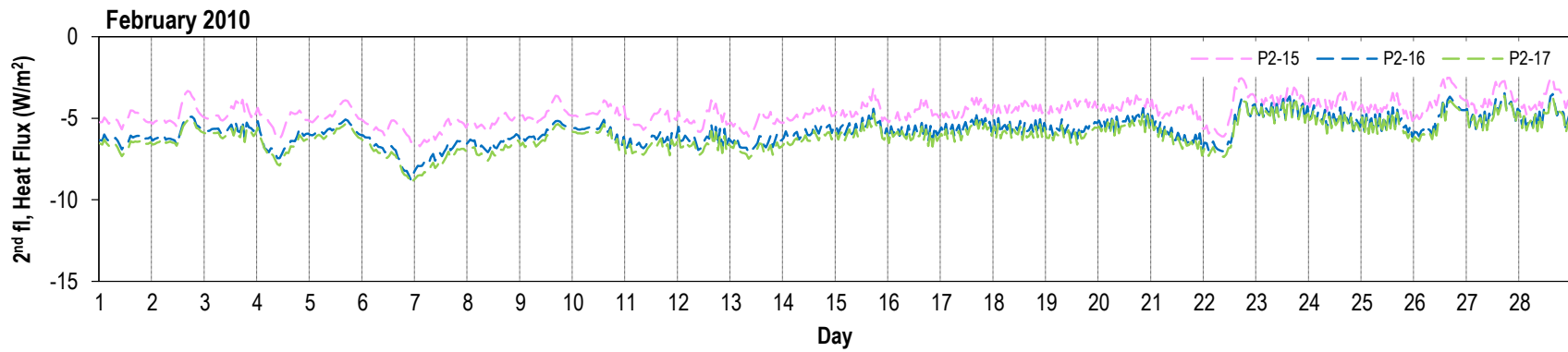
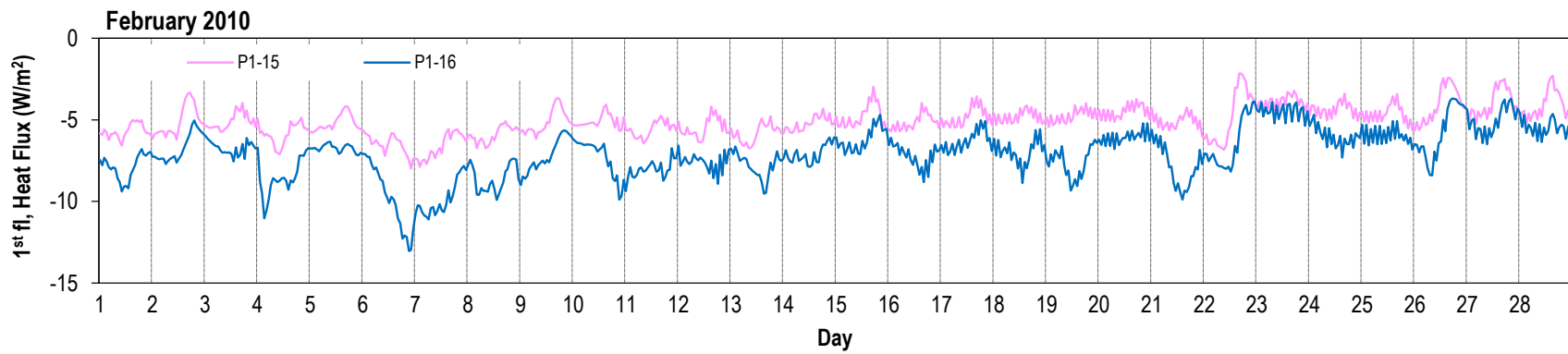
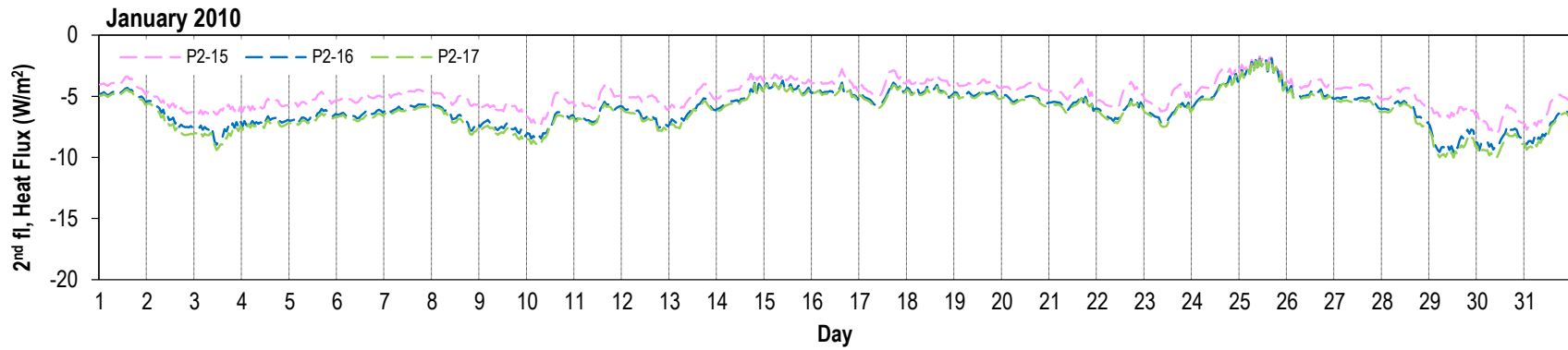

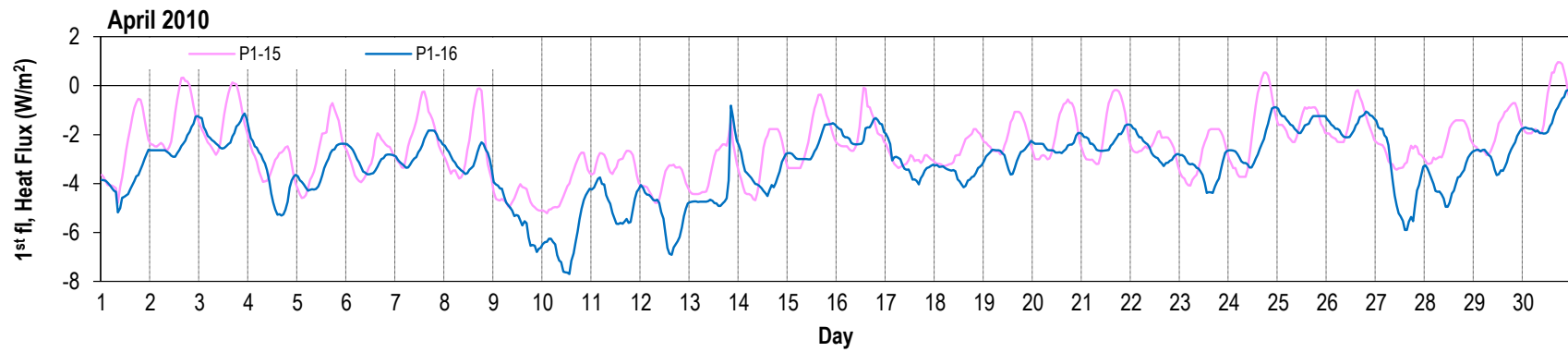
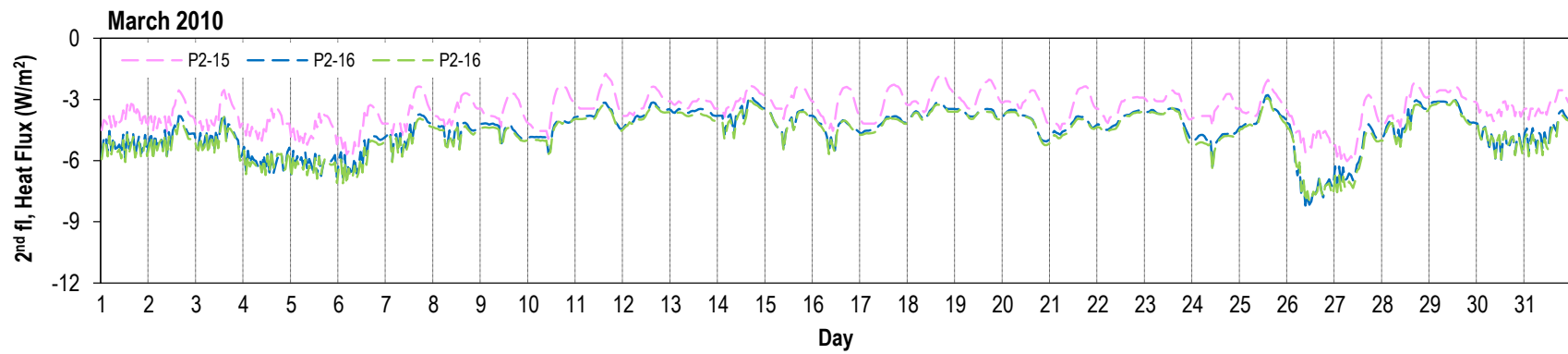
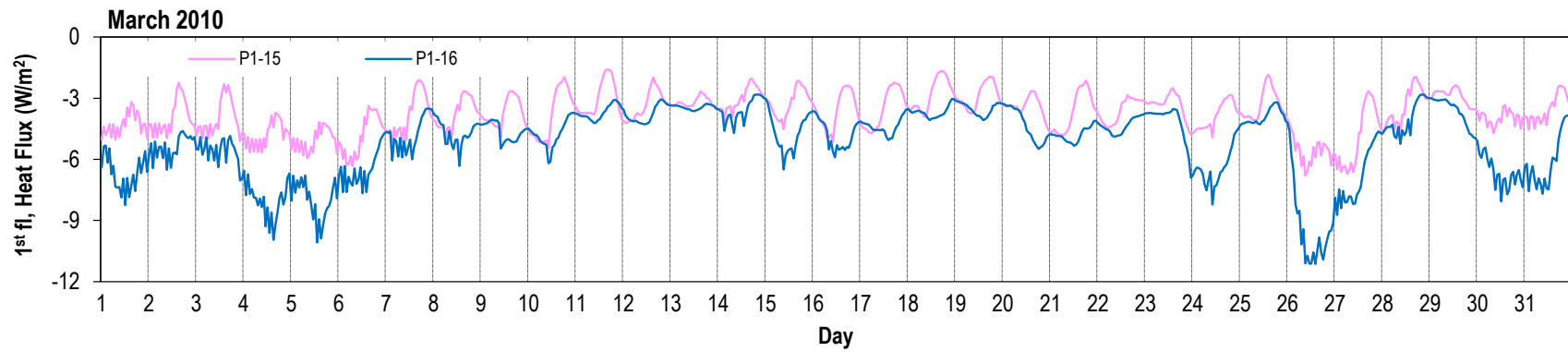

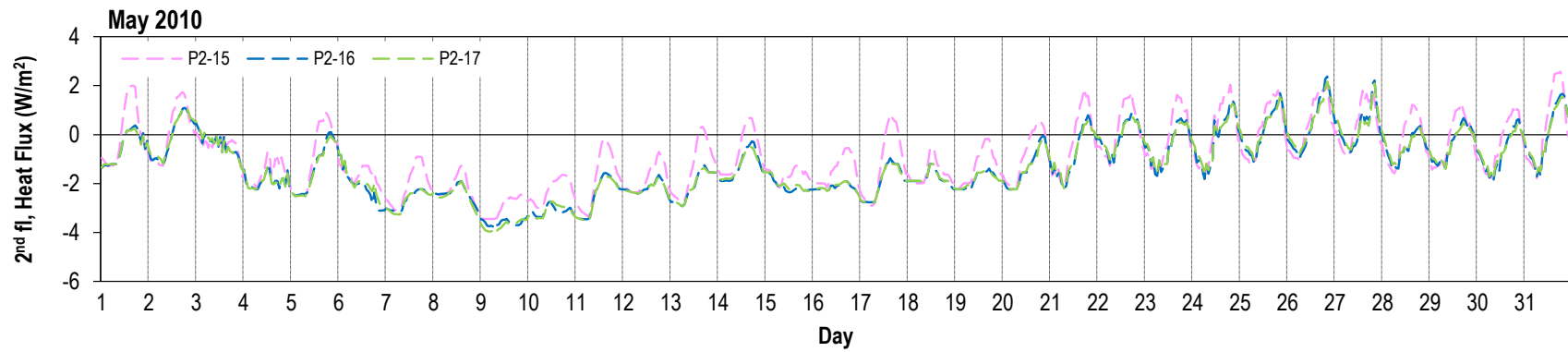
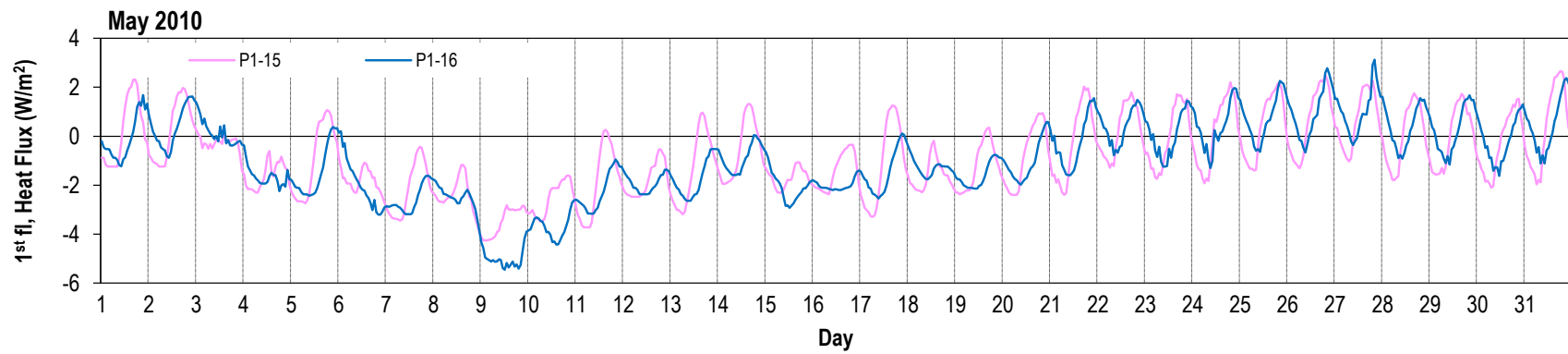
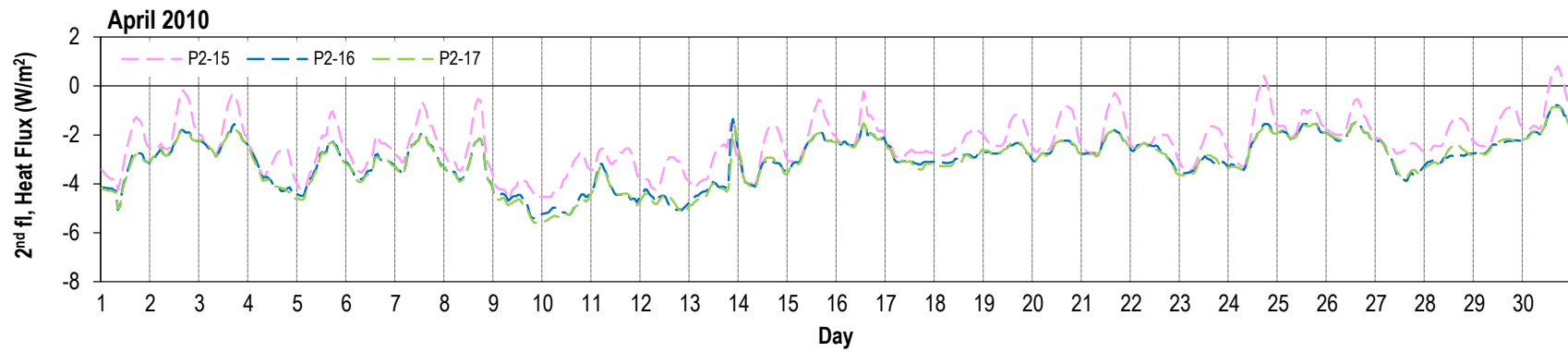

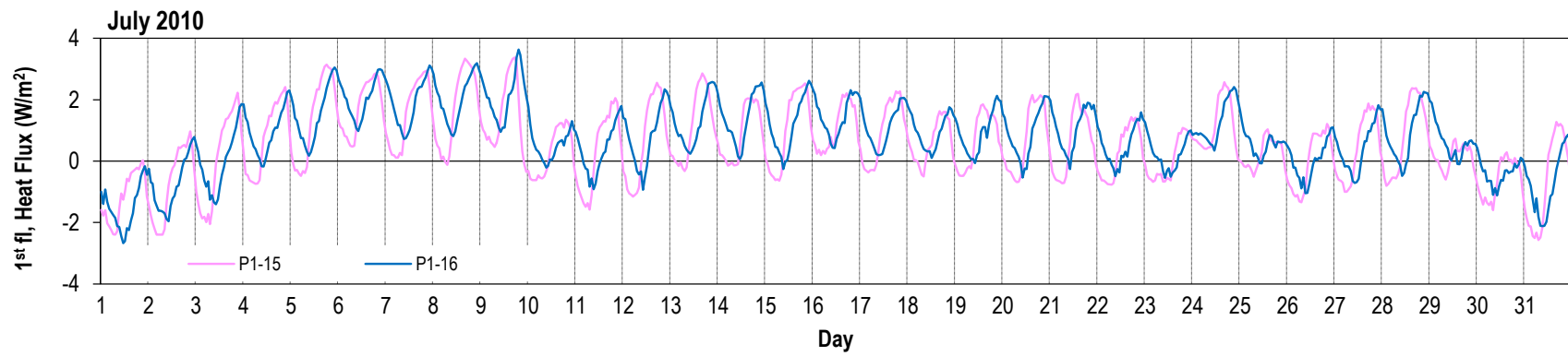
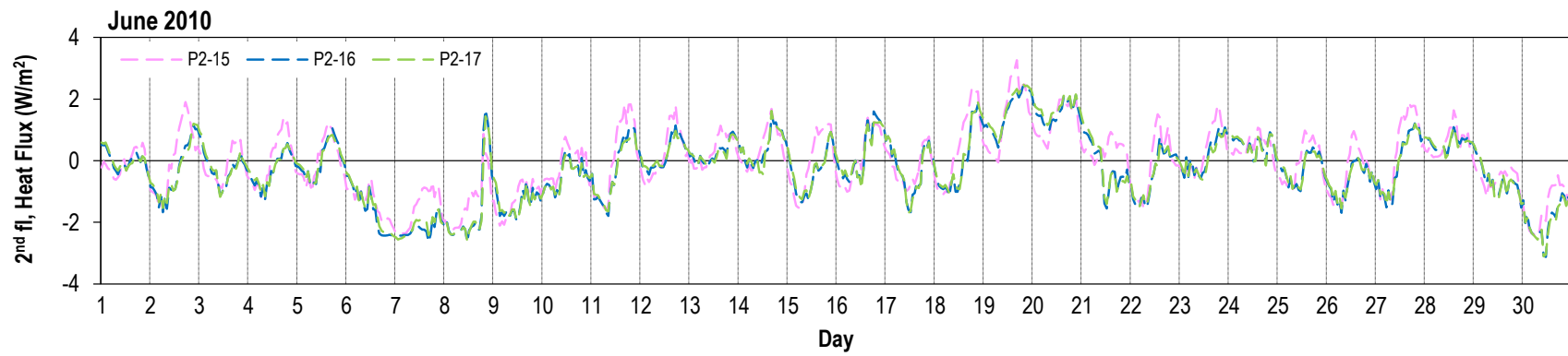
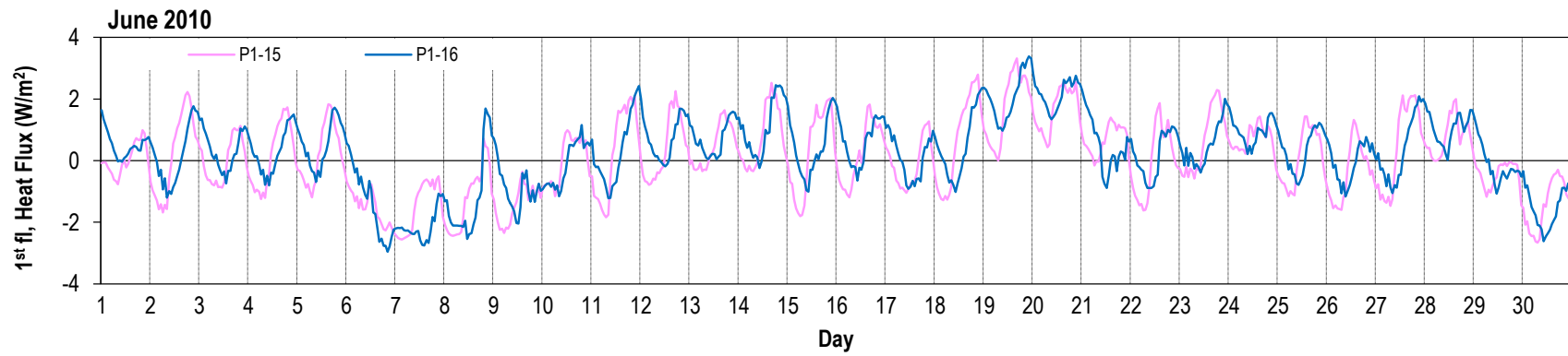

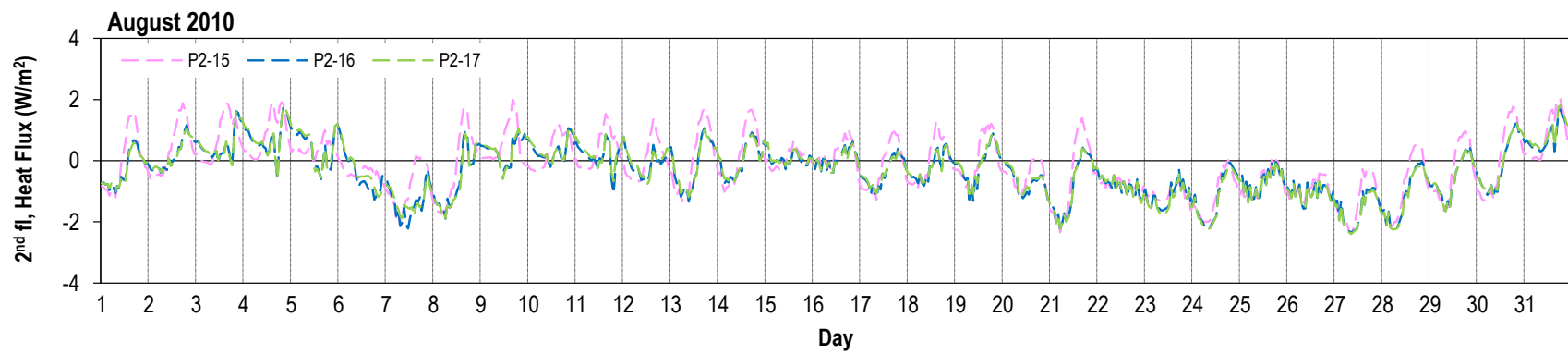
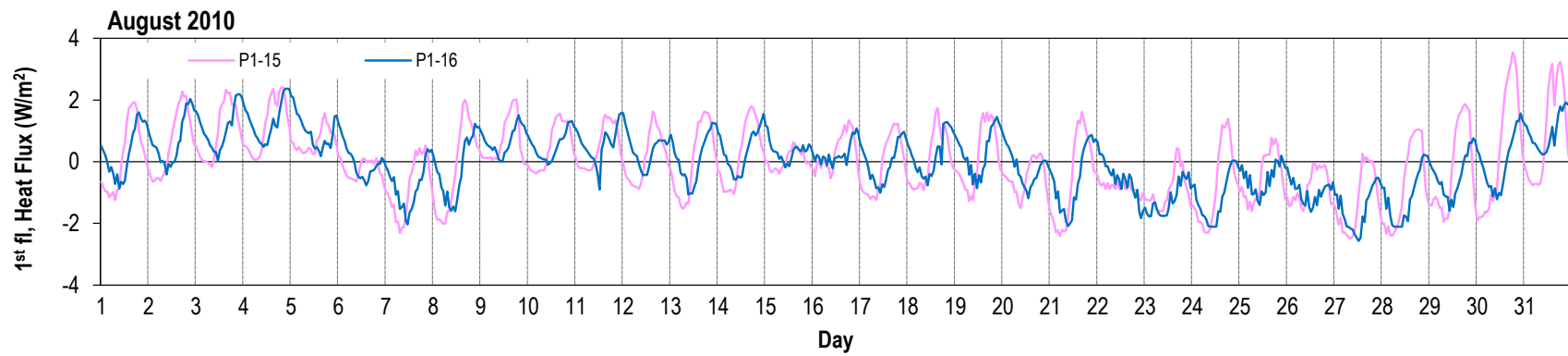
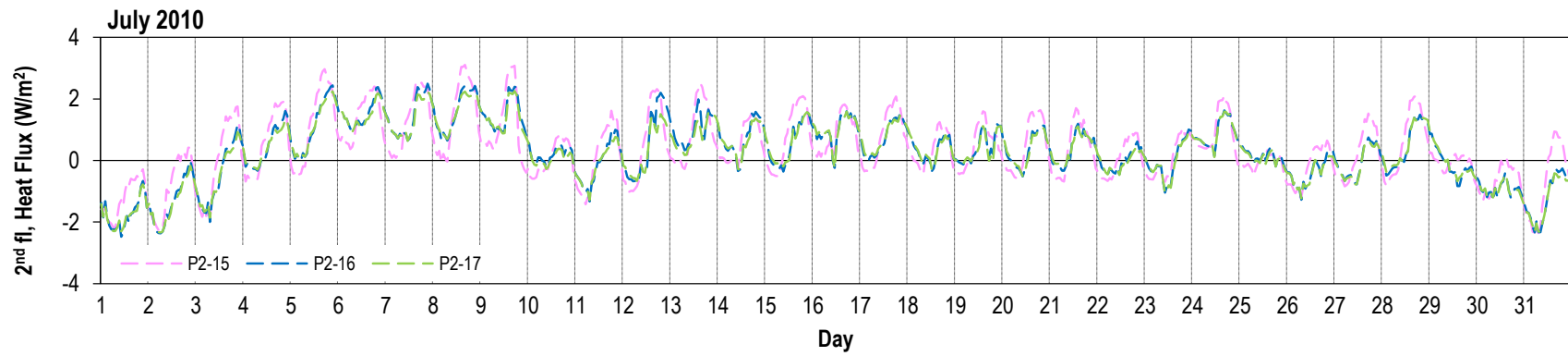

Cooling loads (Wh/m^2). Refer to Figures 25 thru 28 for sensor location.

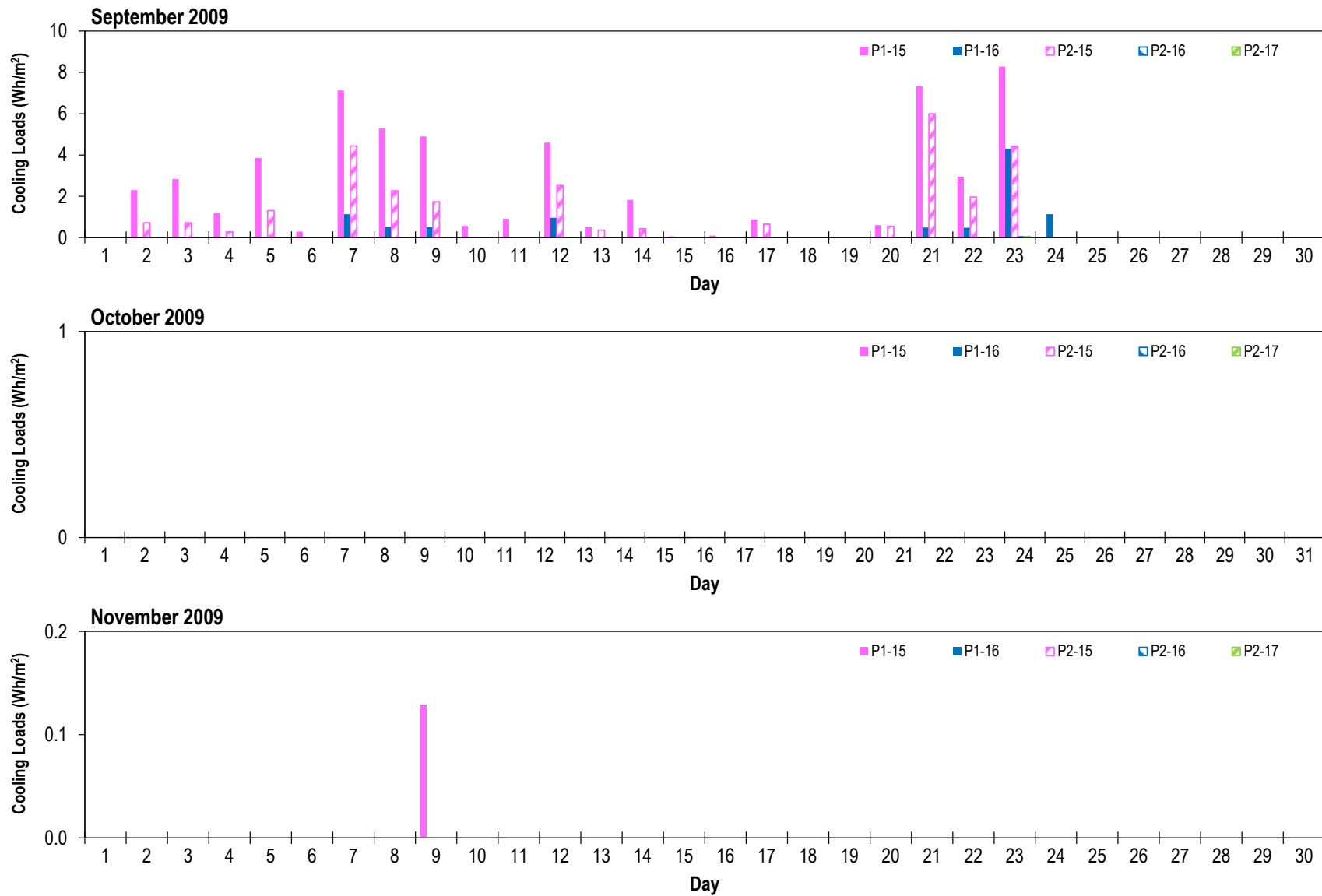

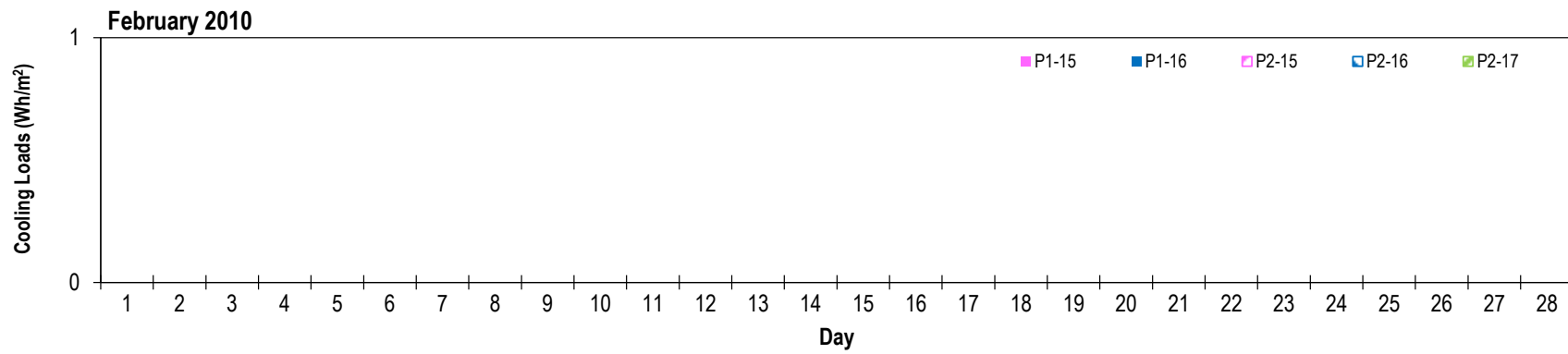
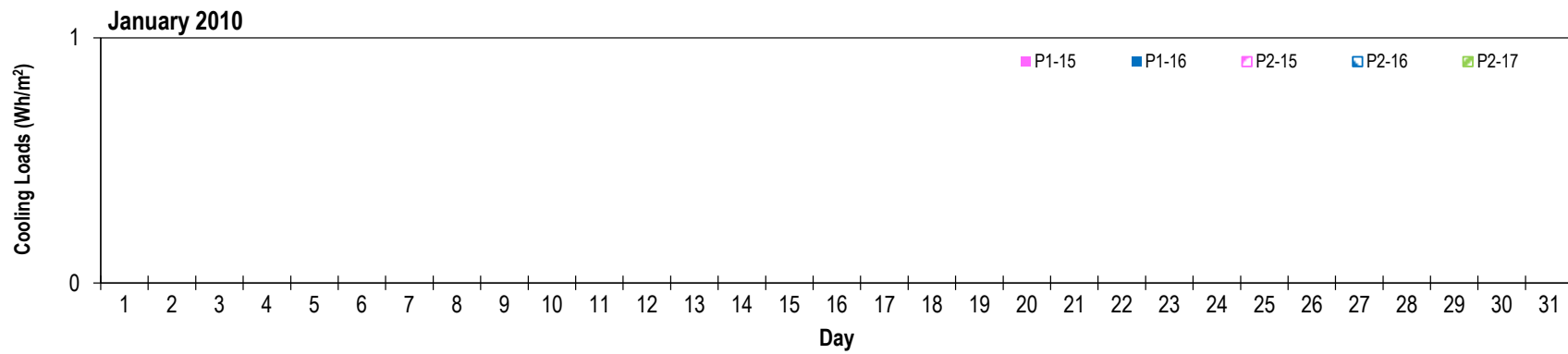
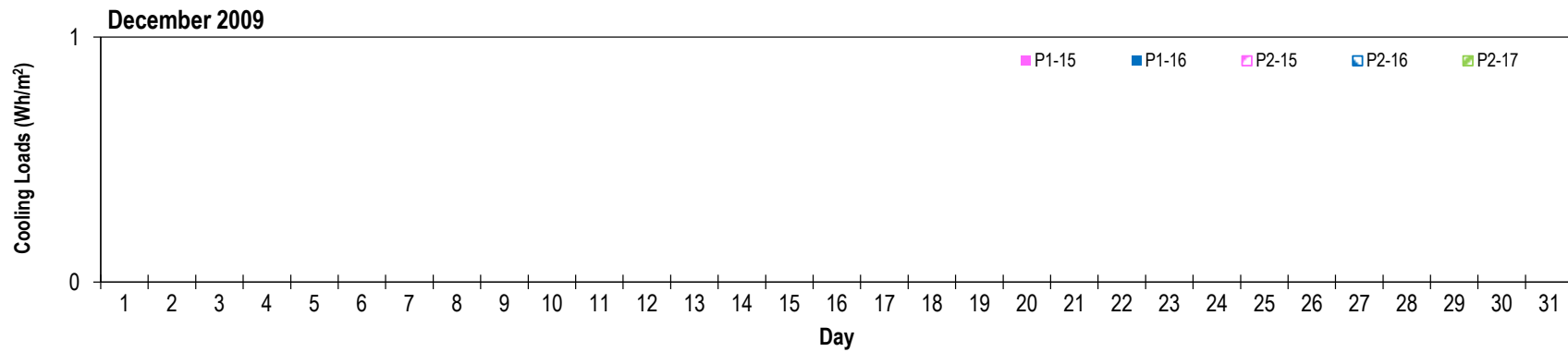

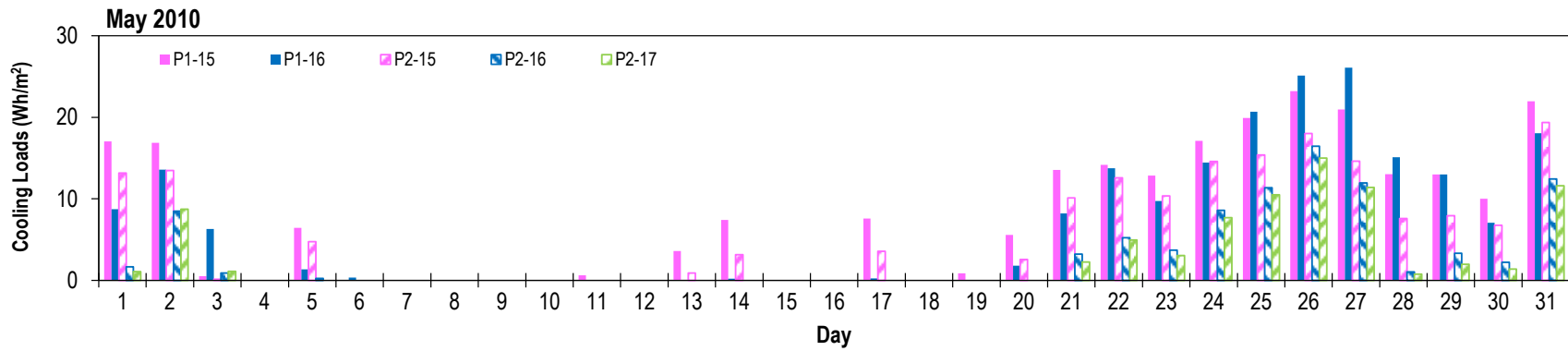
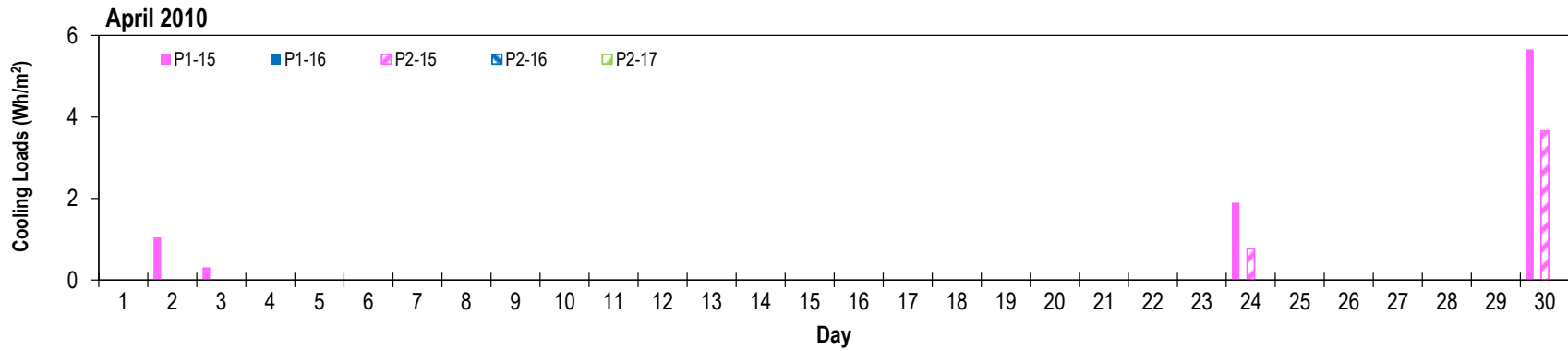
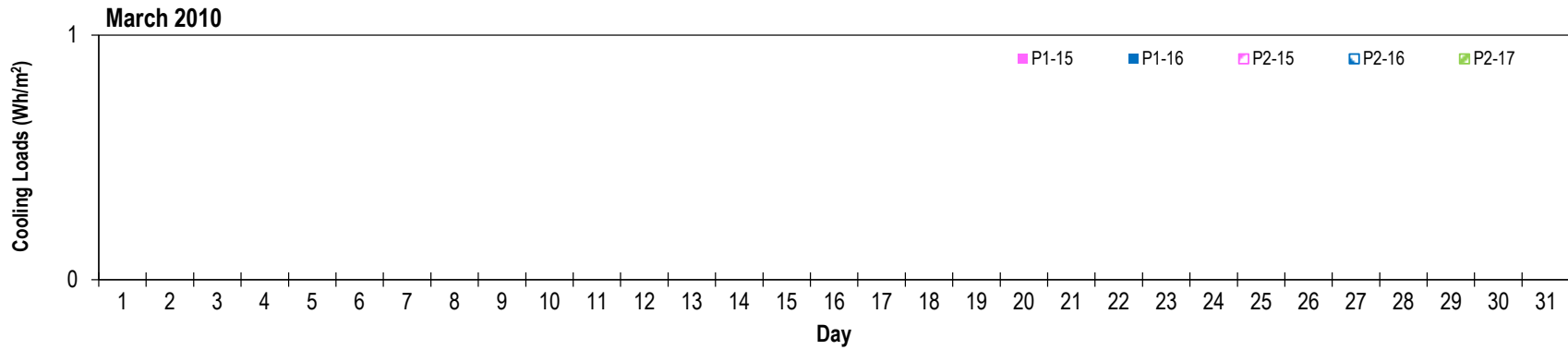

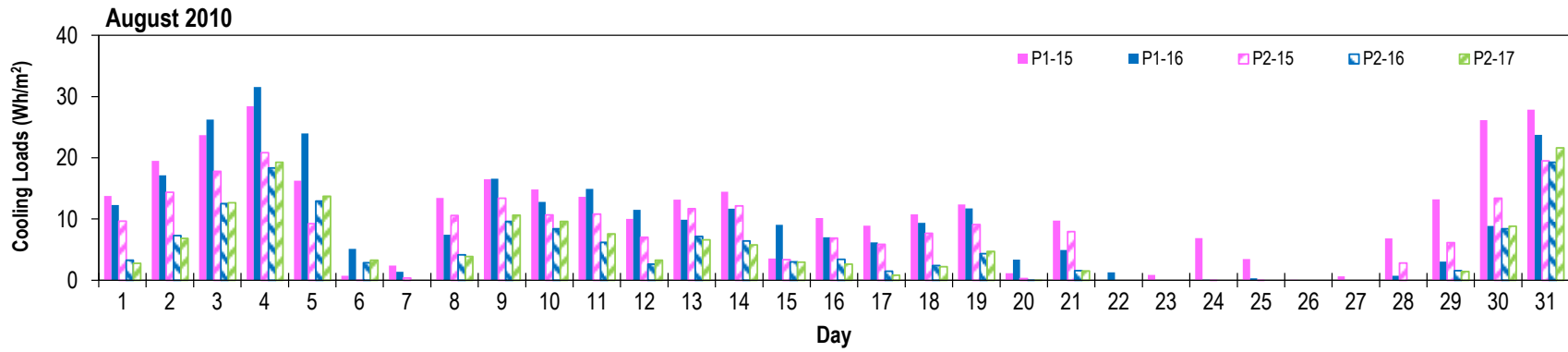
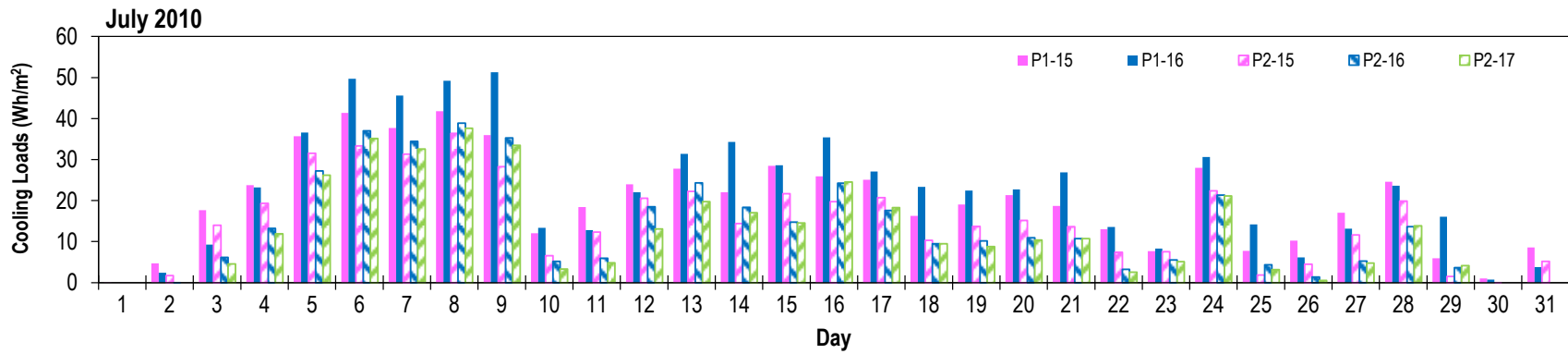
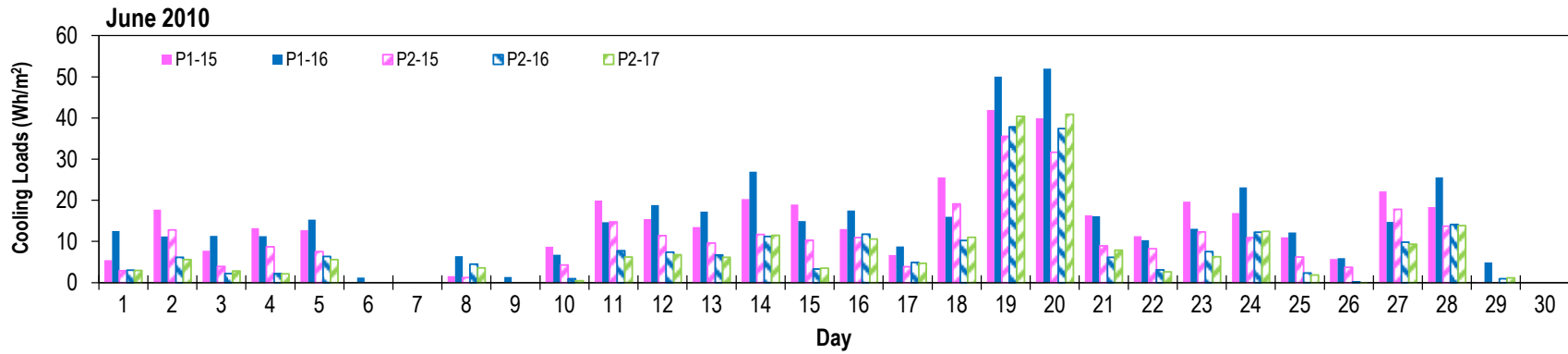

Heating loads (Wh/m^2). Refer to Figures 25 thru 28 for sensor location.

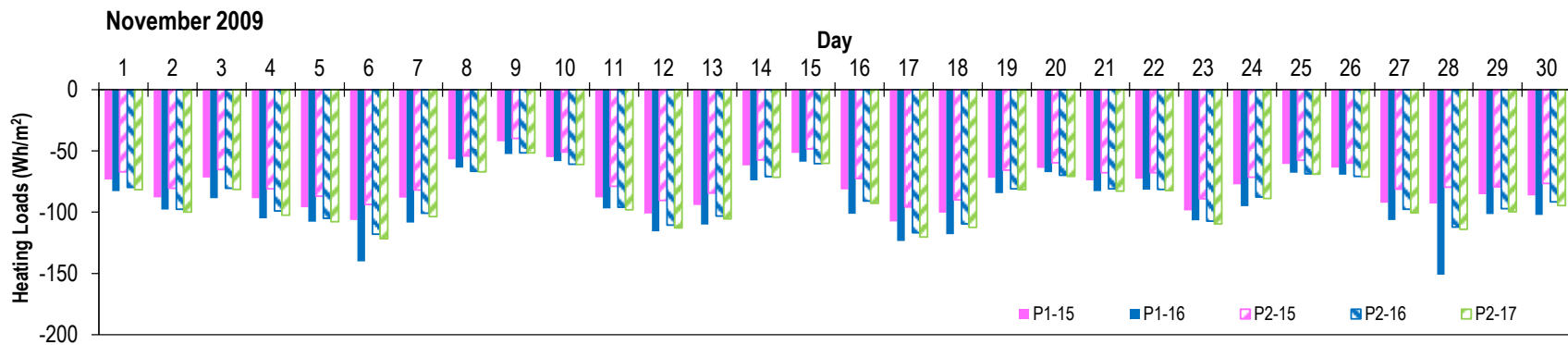
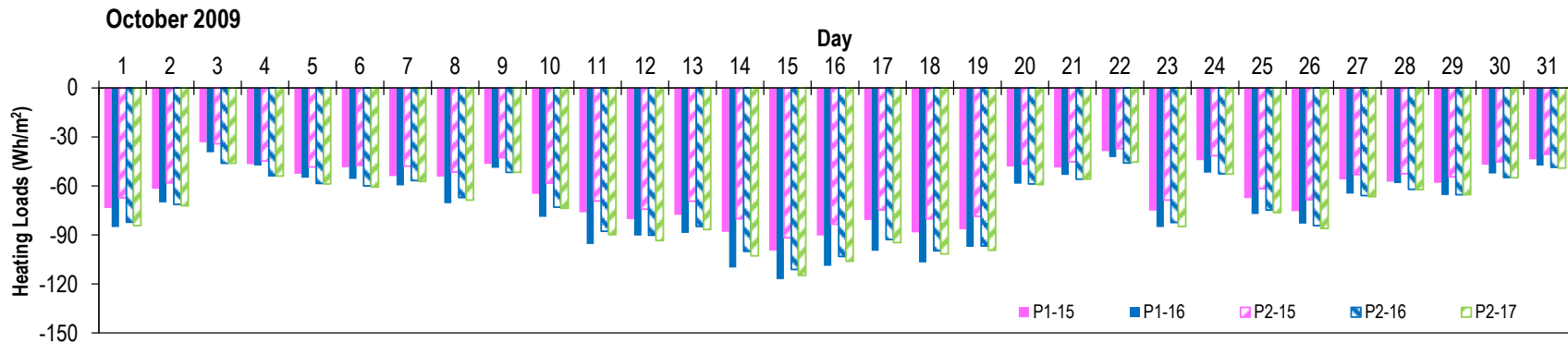
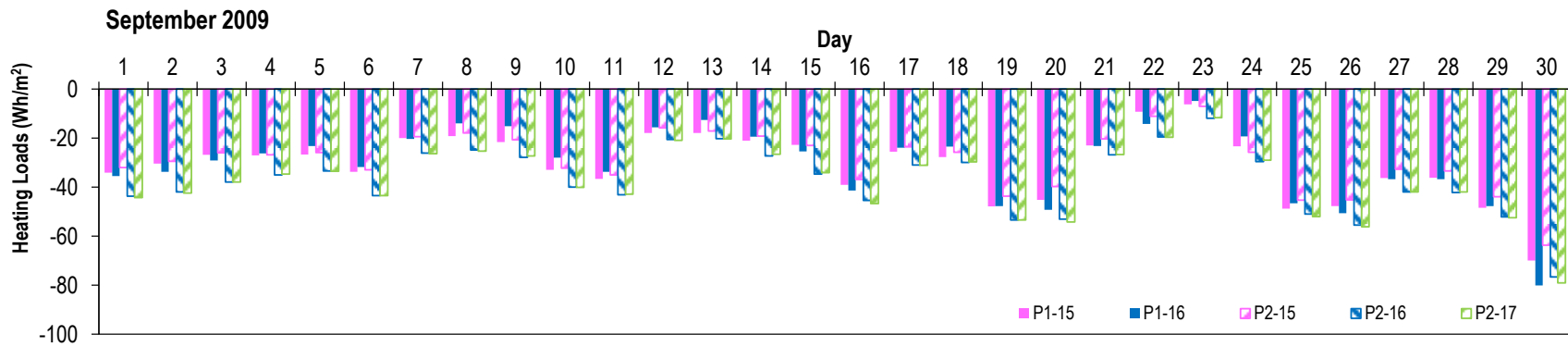

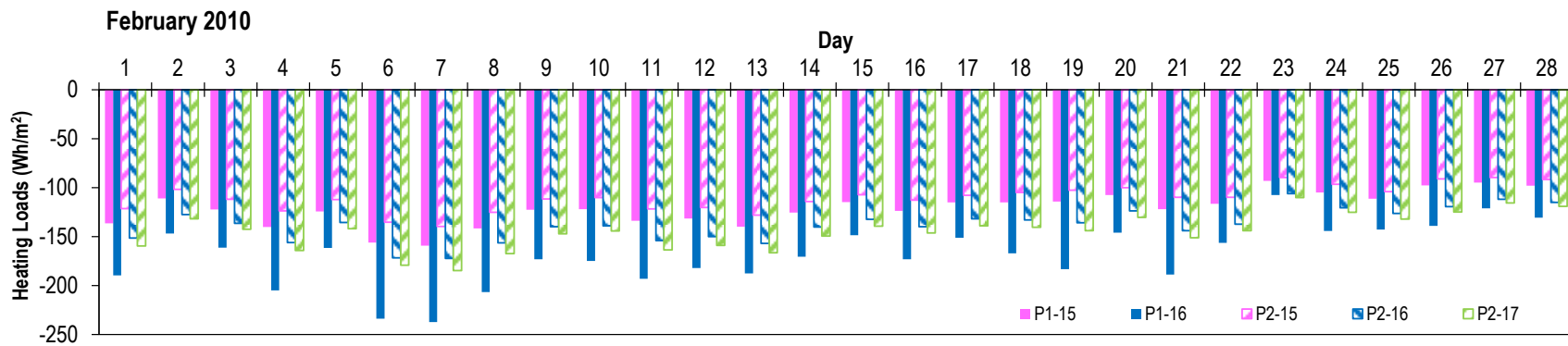
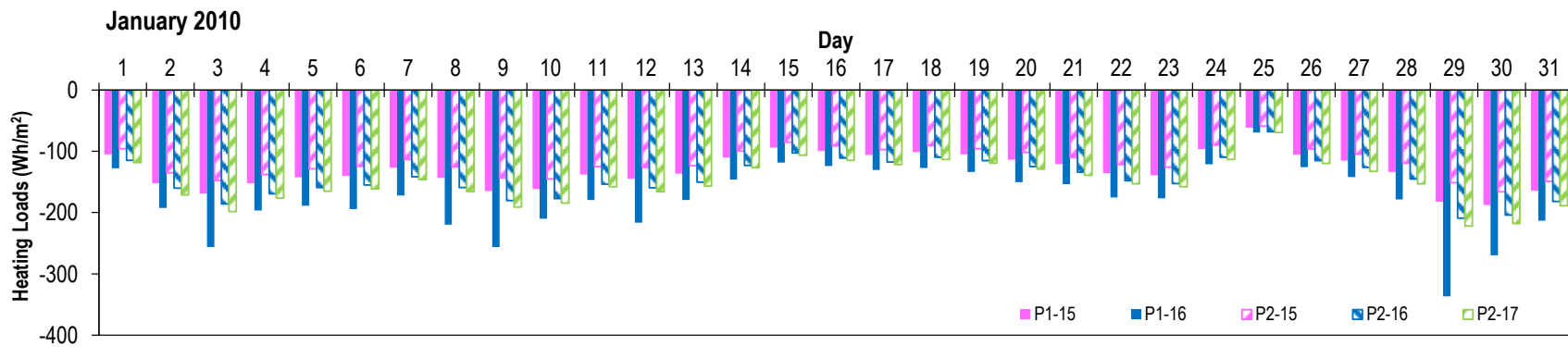
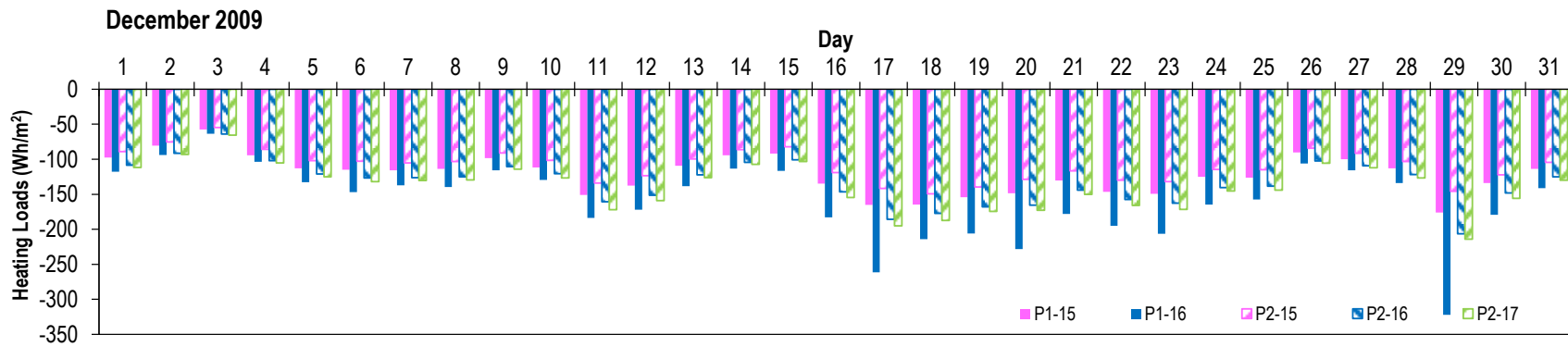

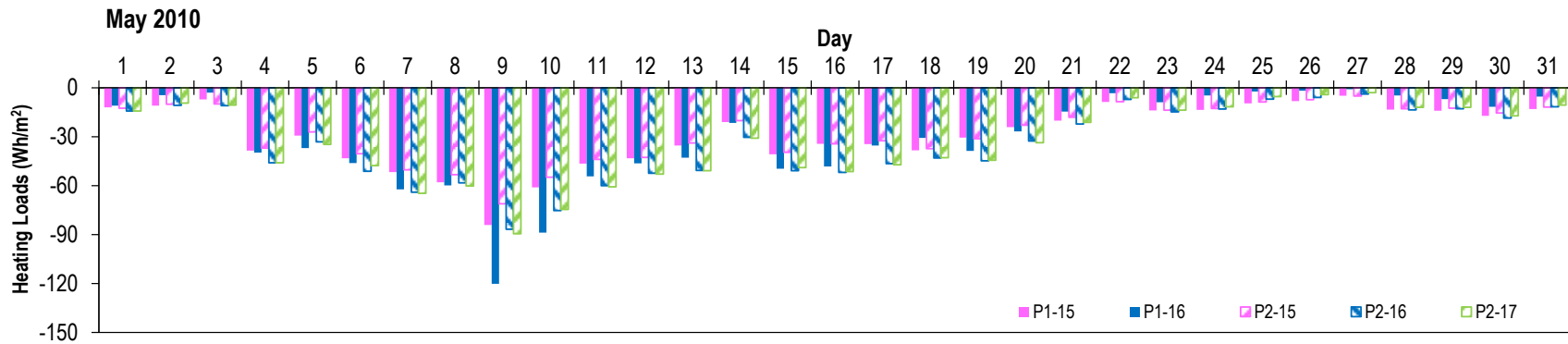
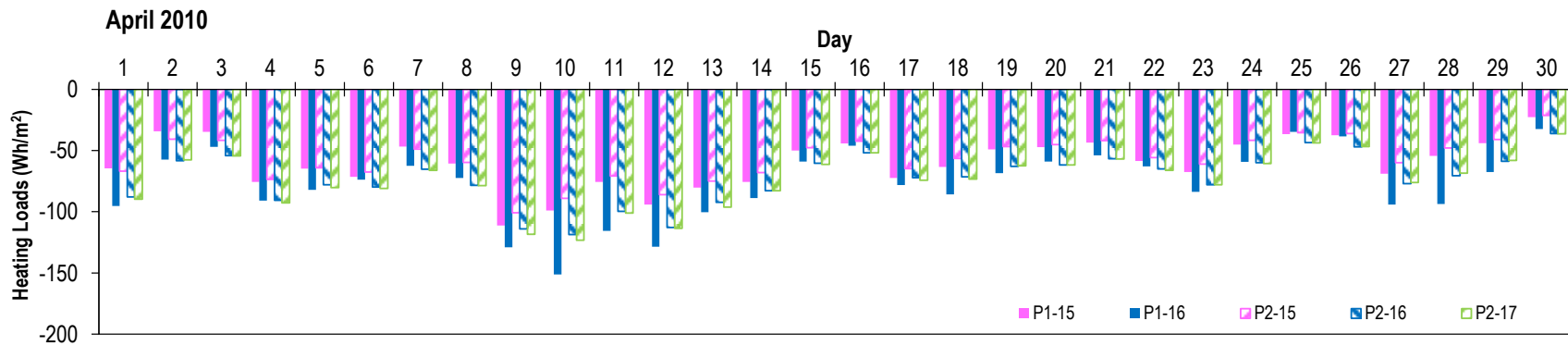
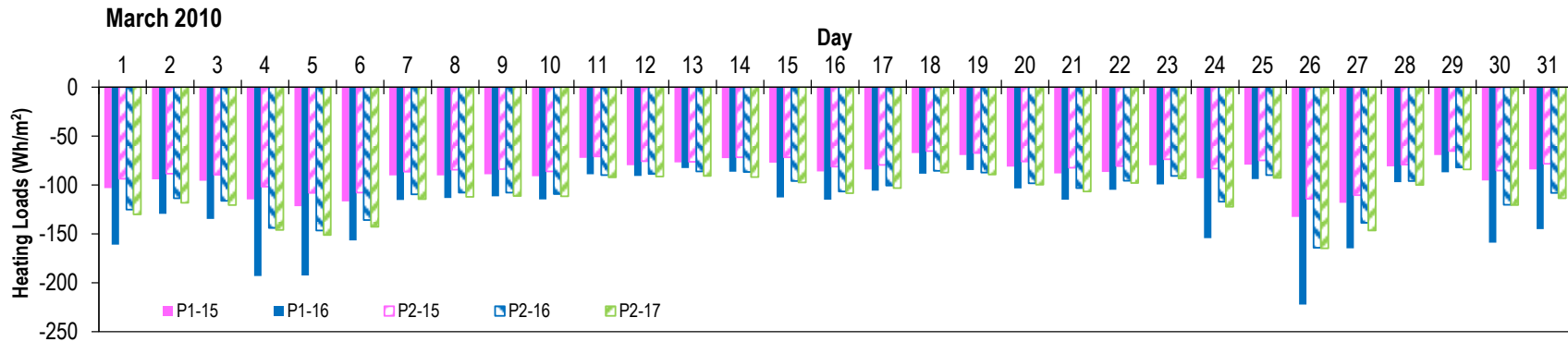

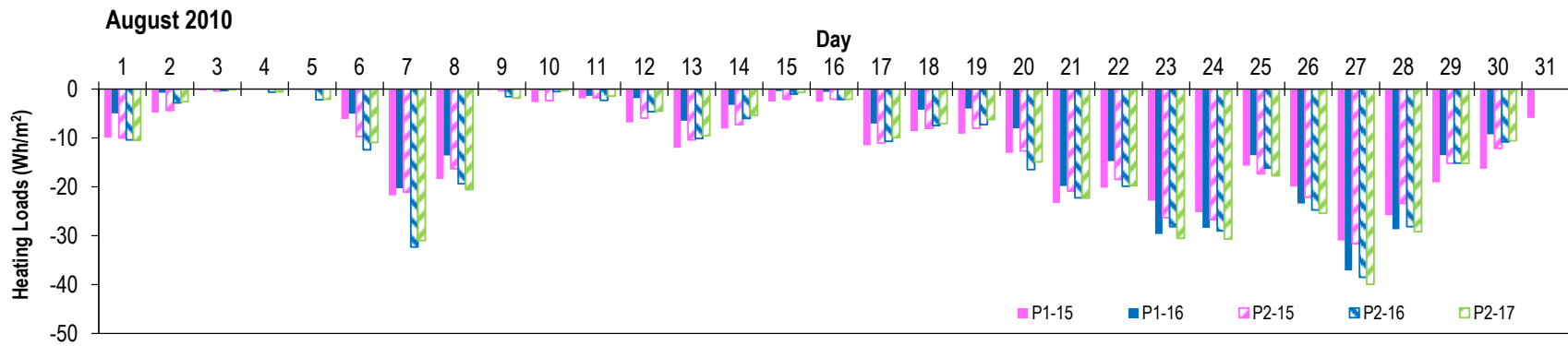
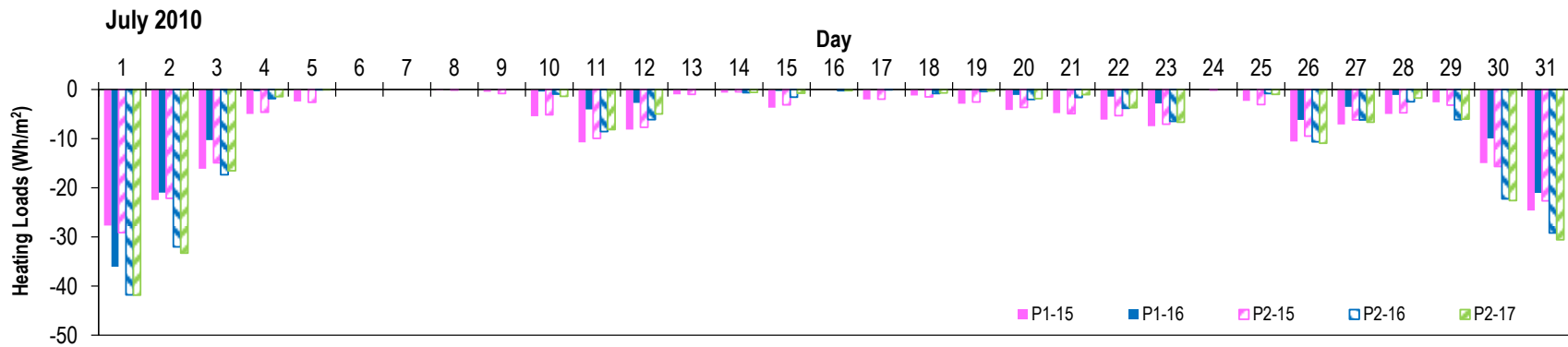
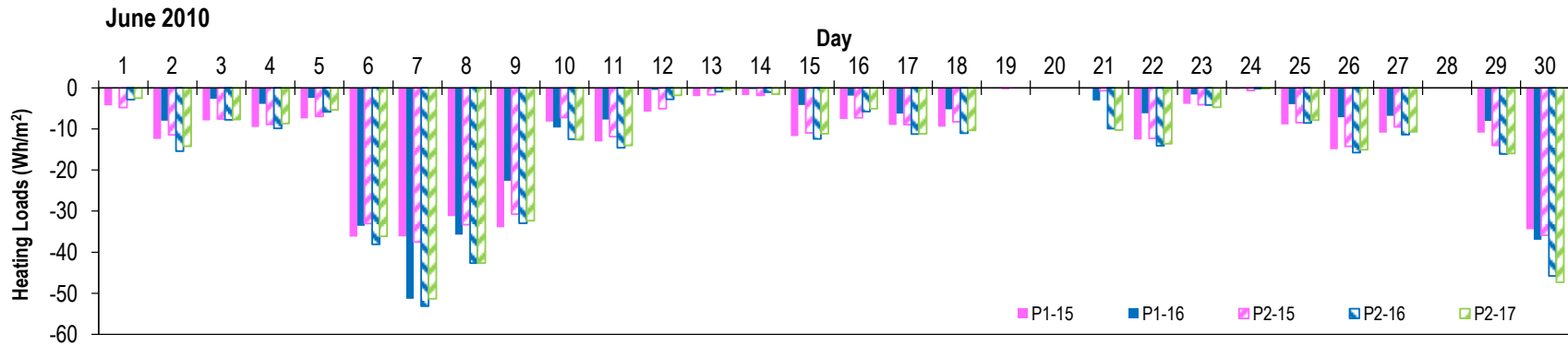

Appendix B: East Panels

Temperature (°C) at exterior side of stud cavity. Refer to Figures 25 thru 28 for sensor location.

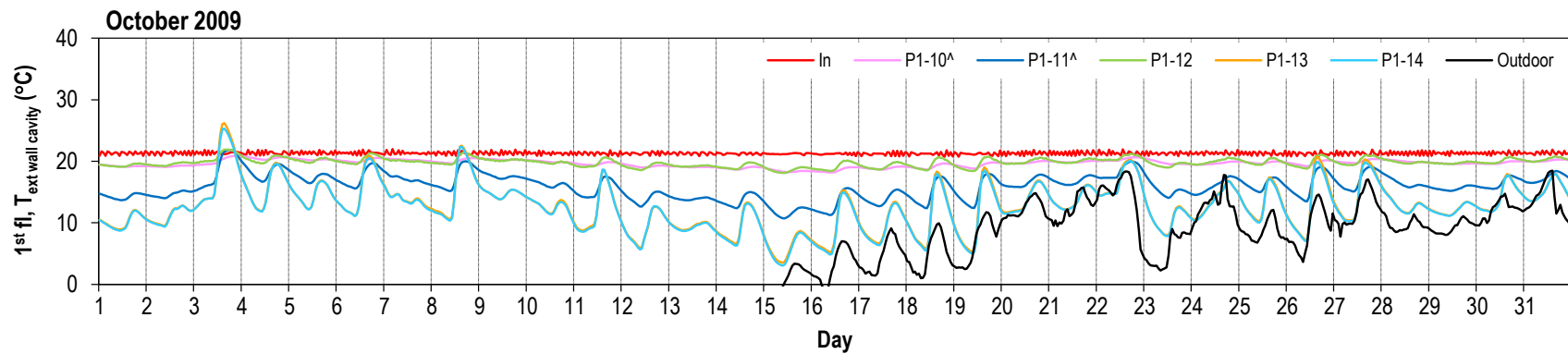
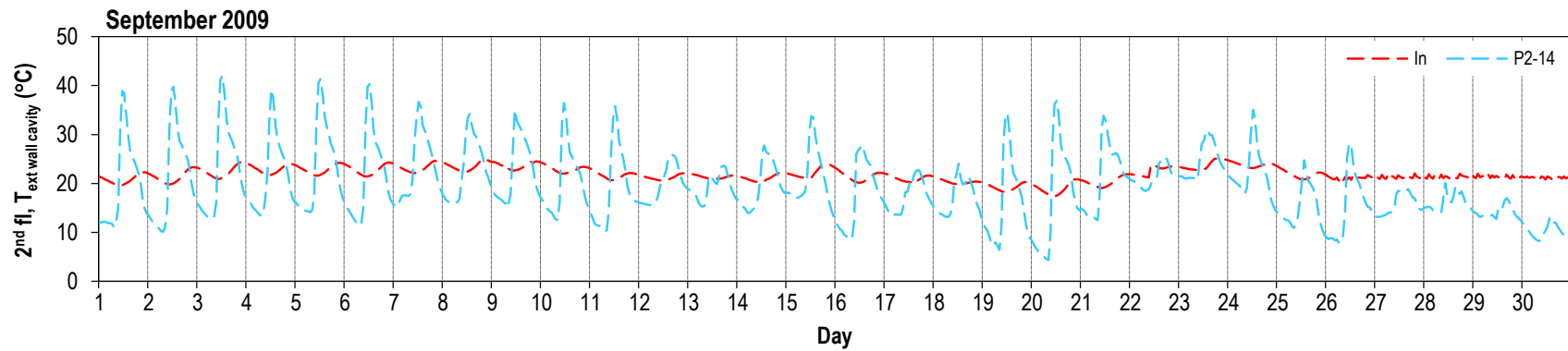
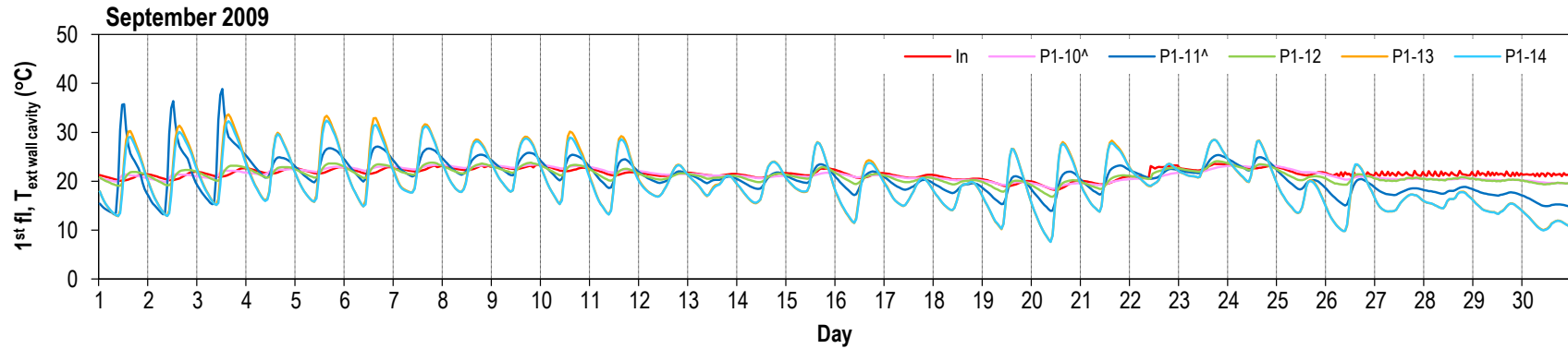

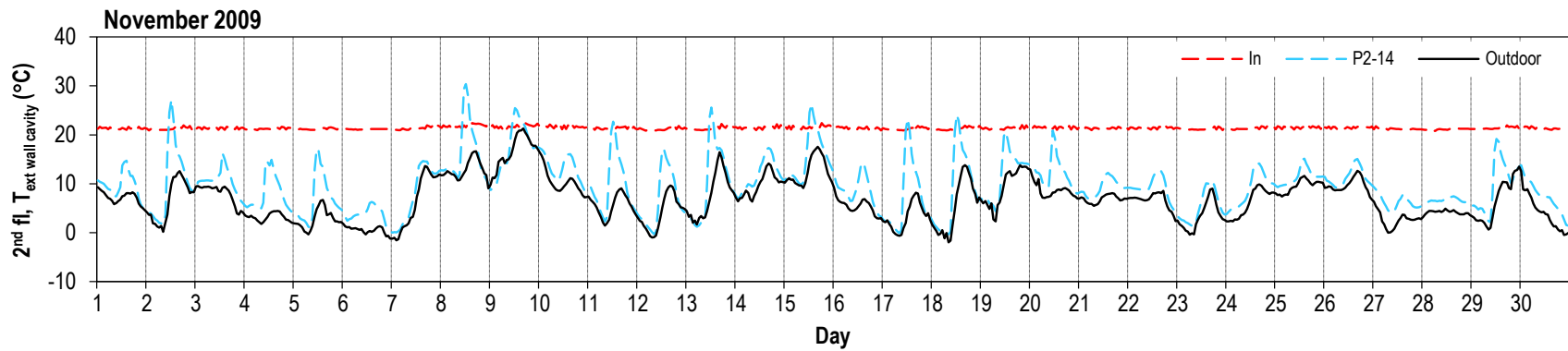
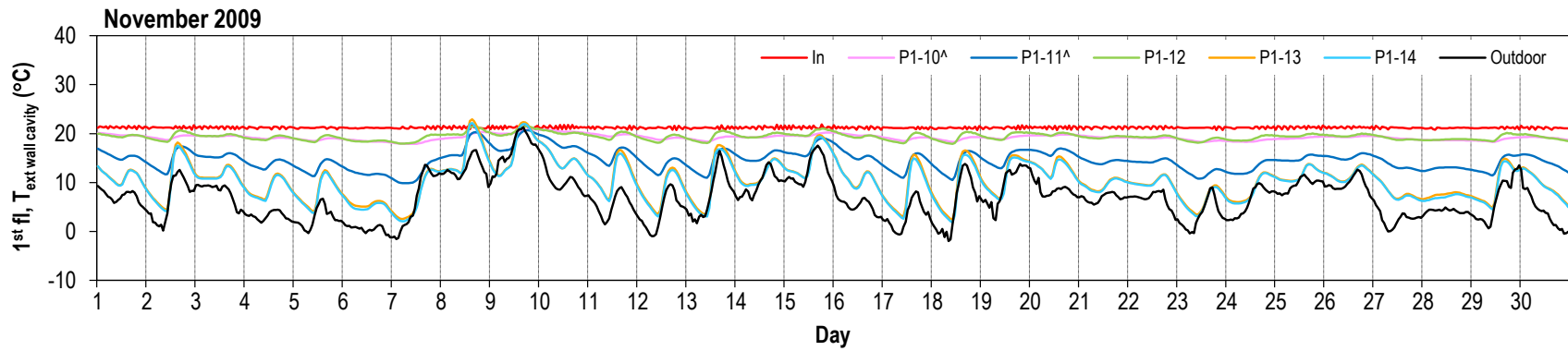
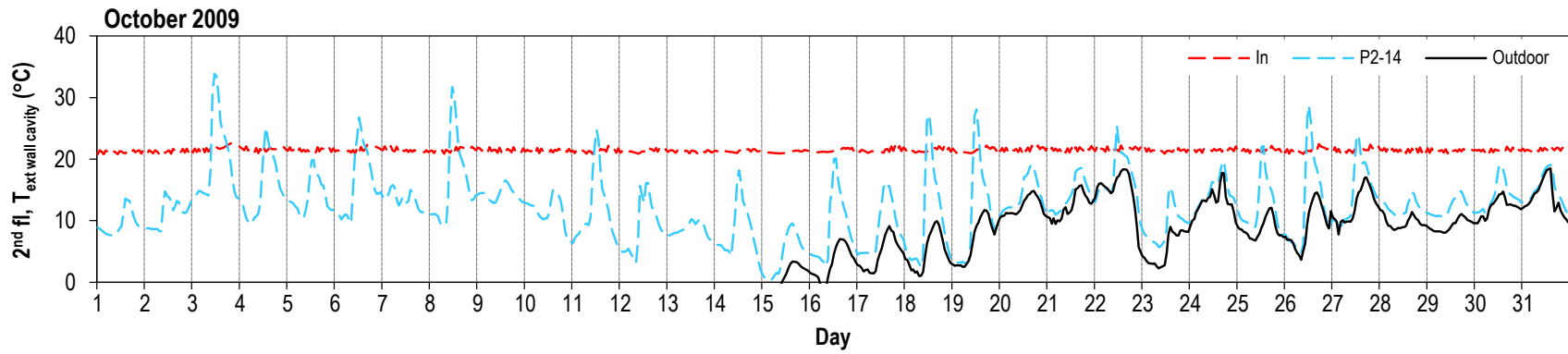

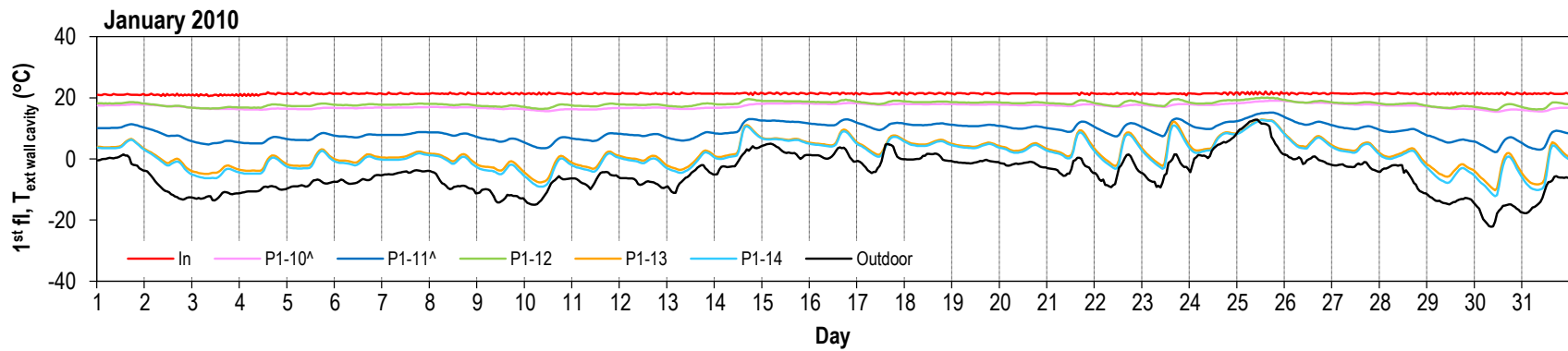
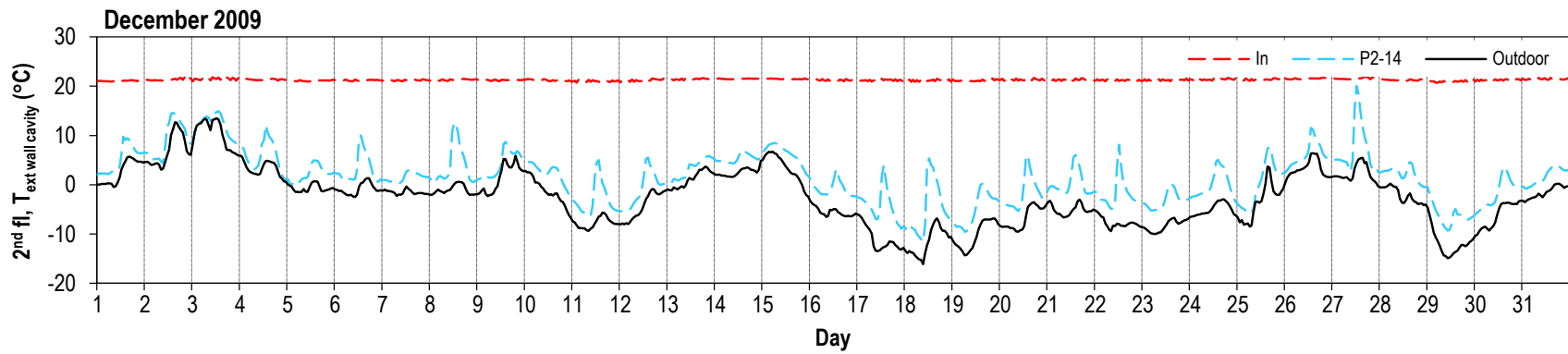
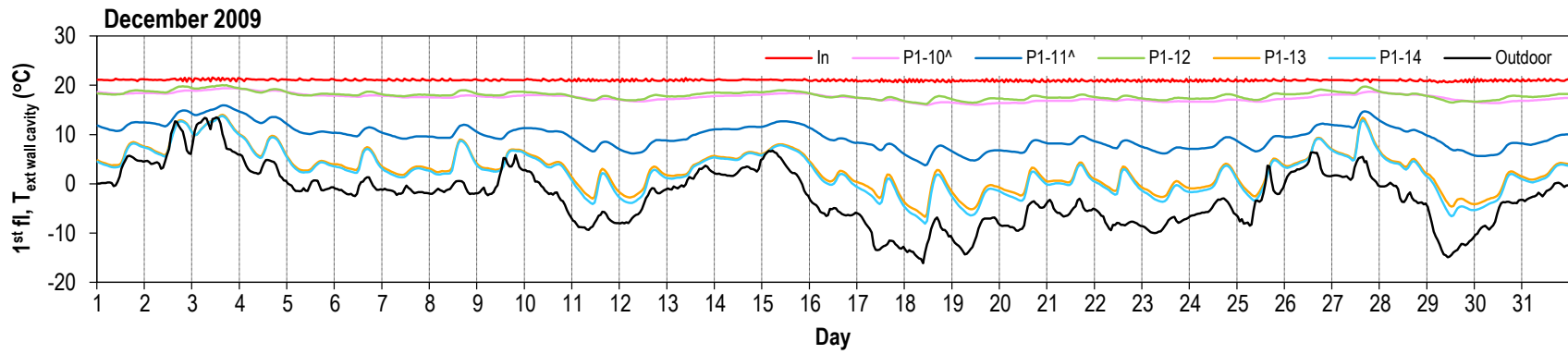

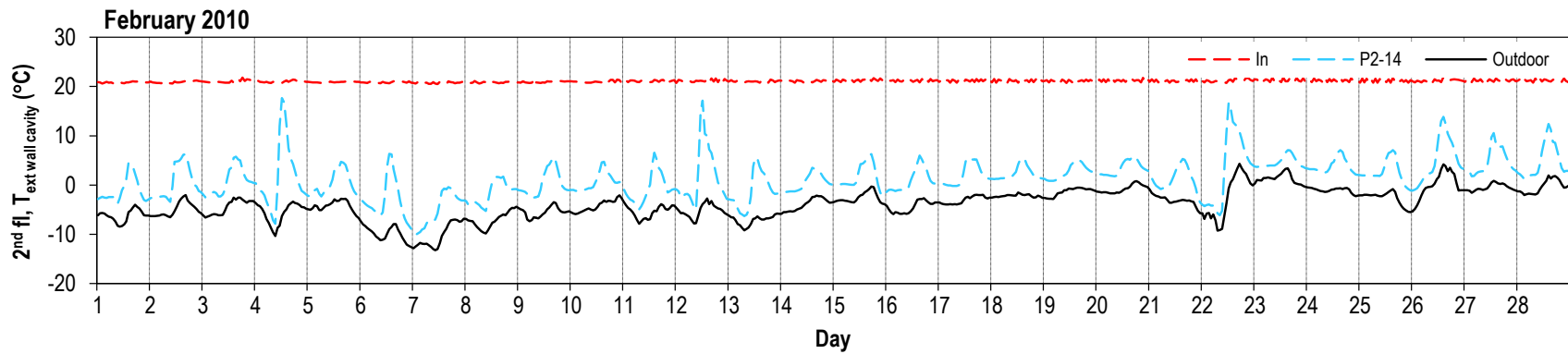
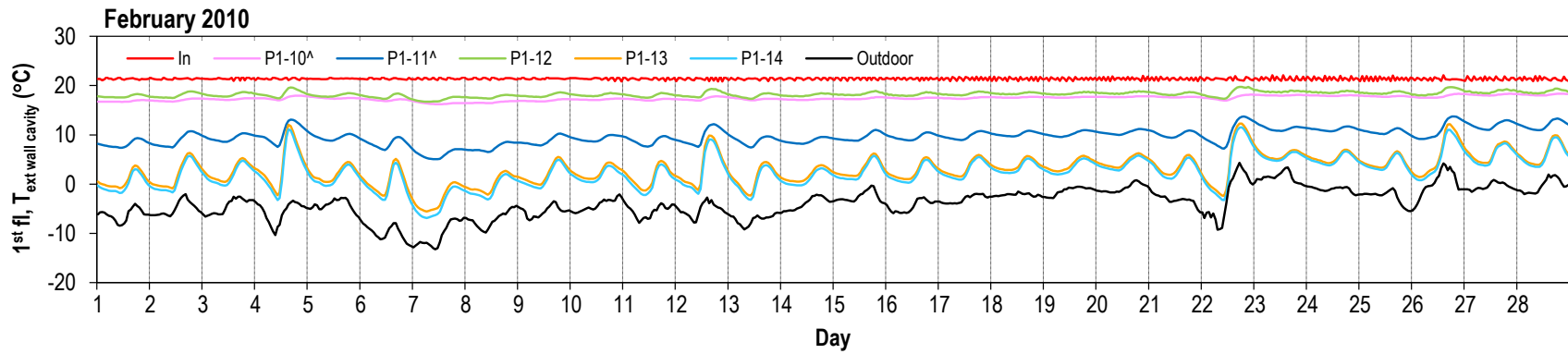
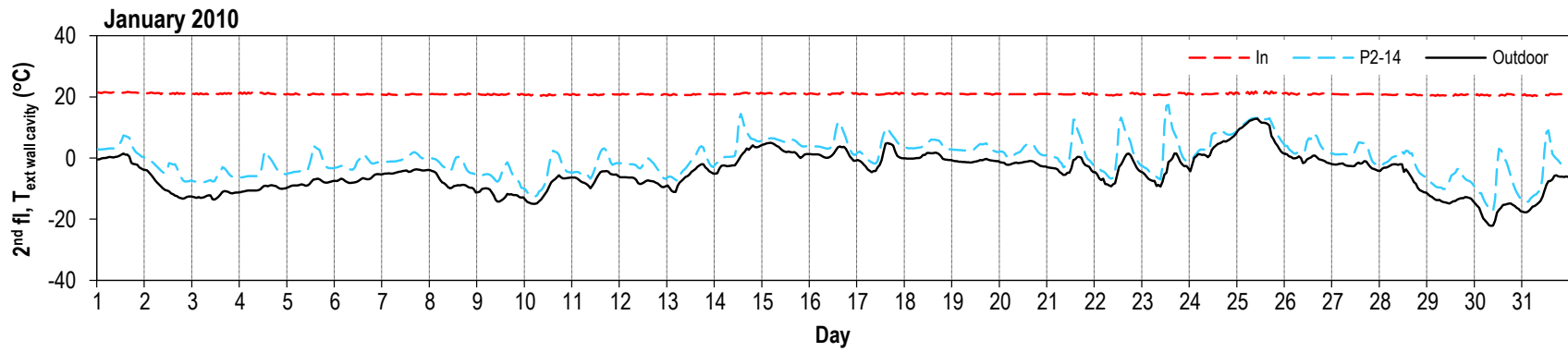

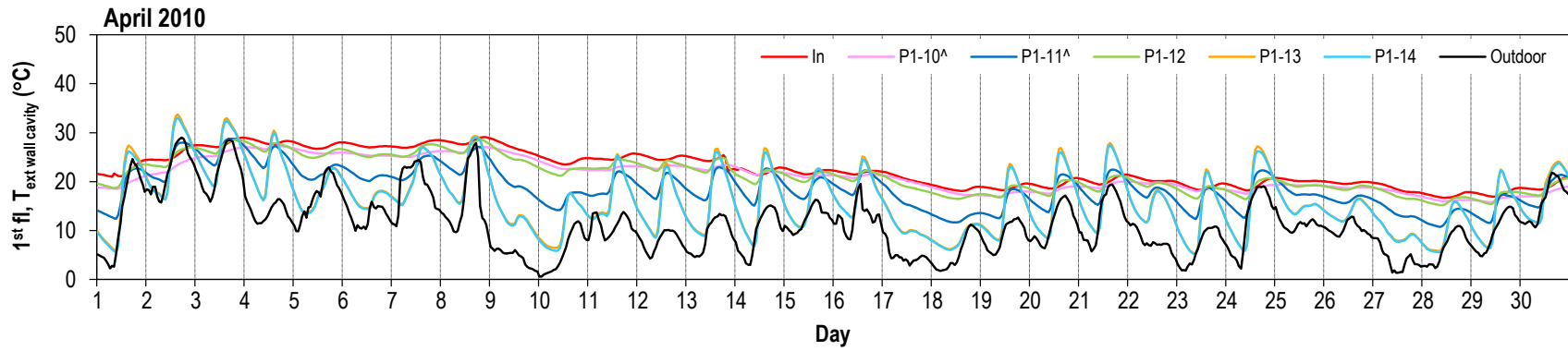
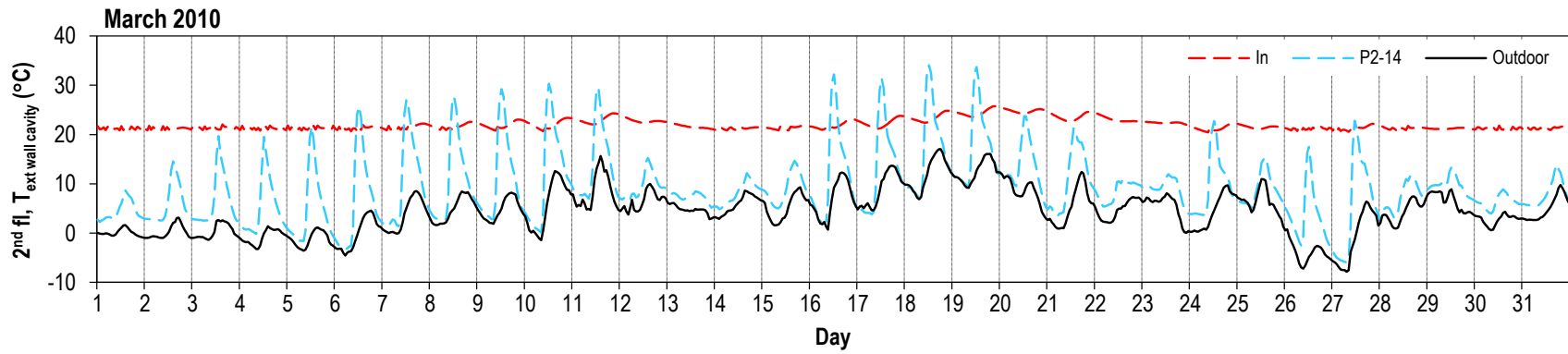
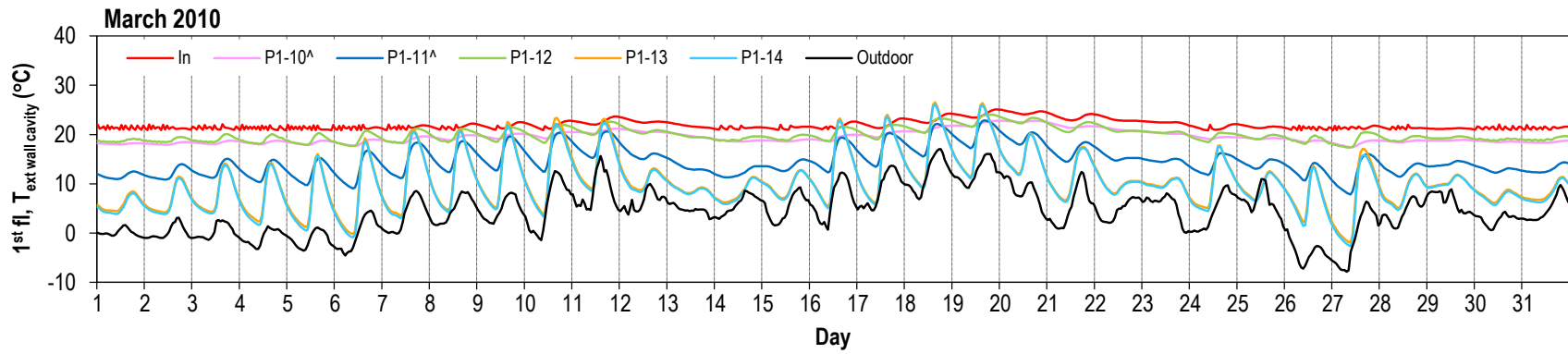

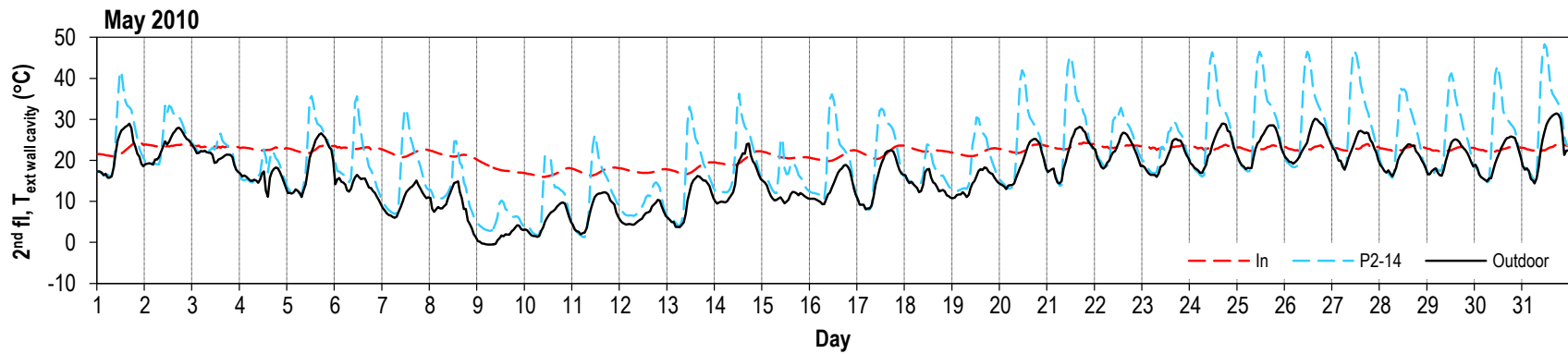
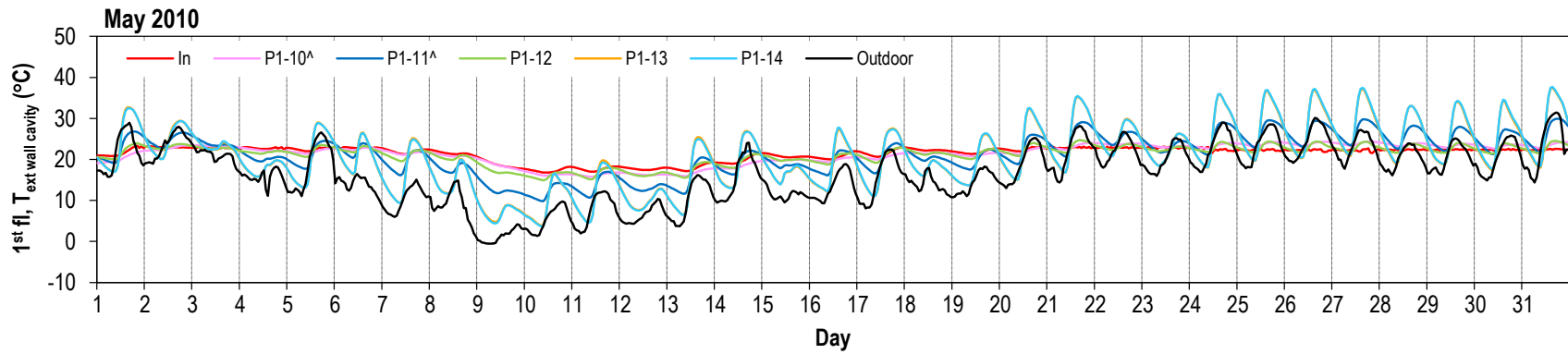
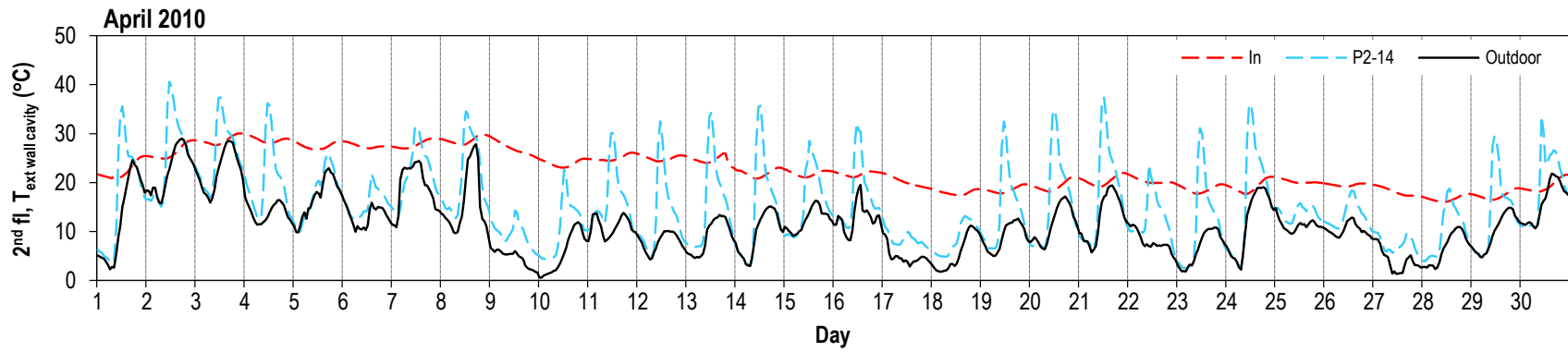

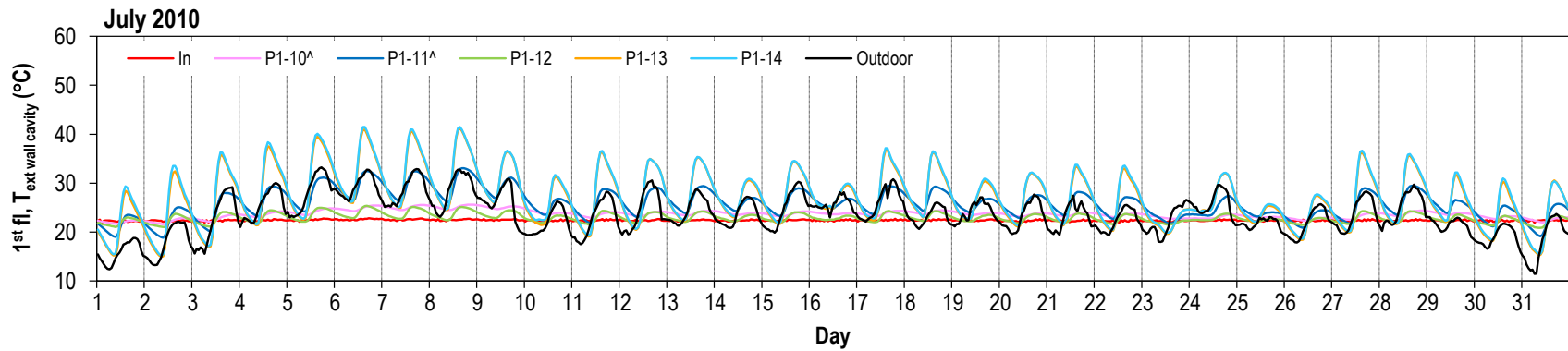
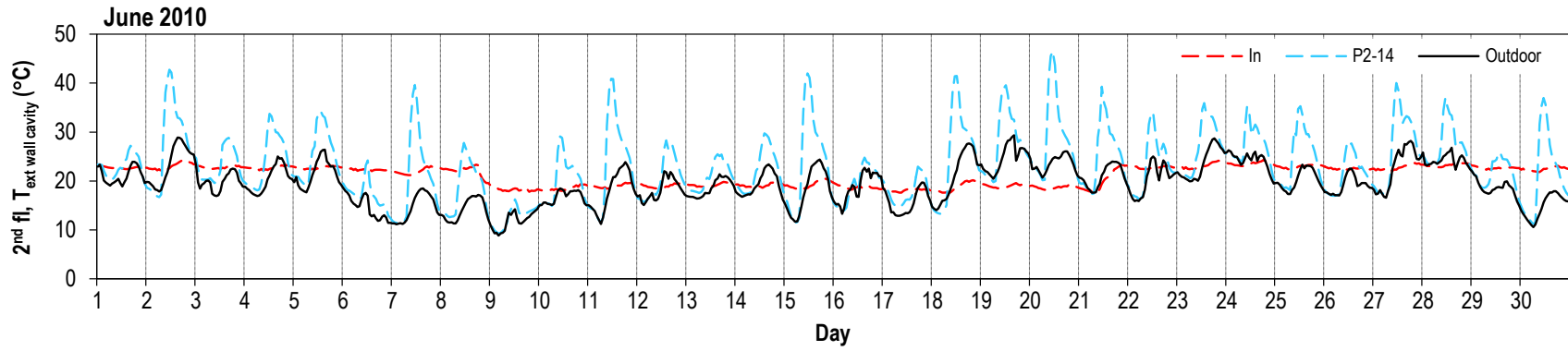
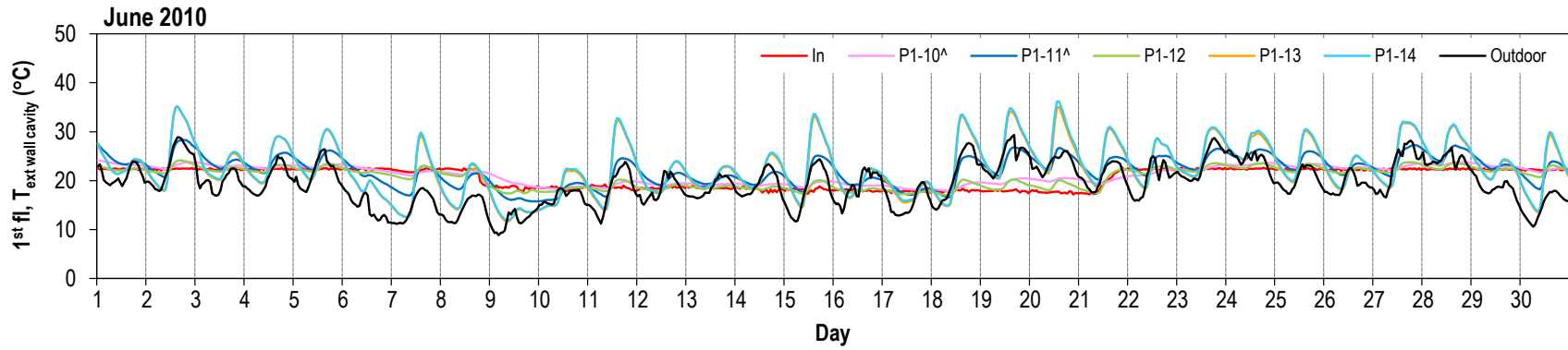

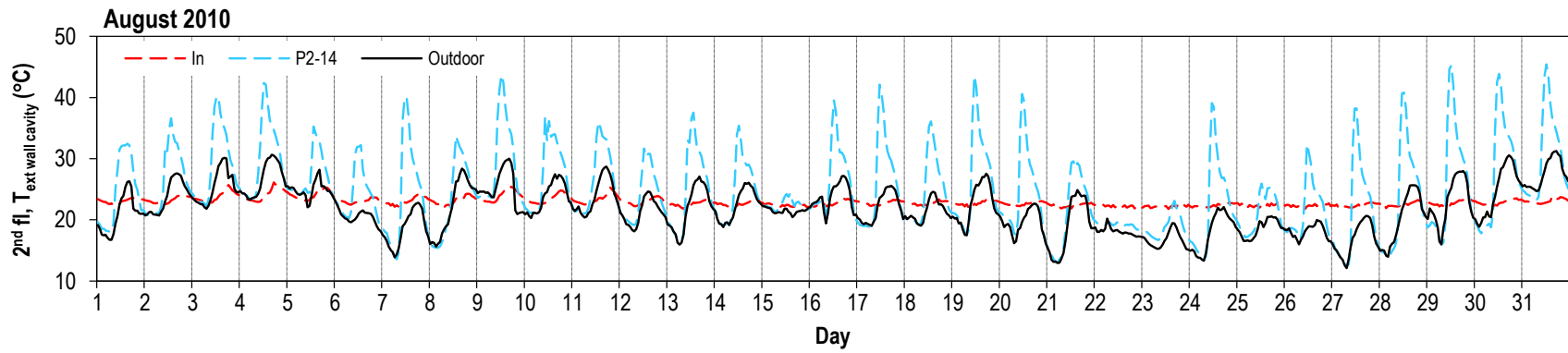
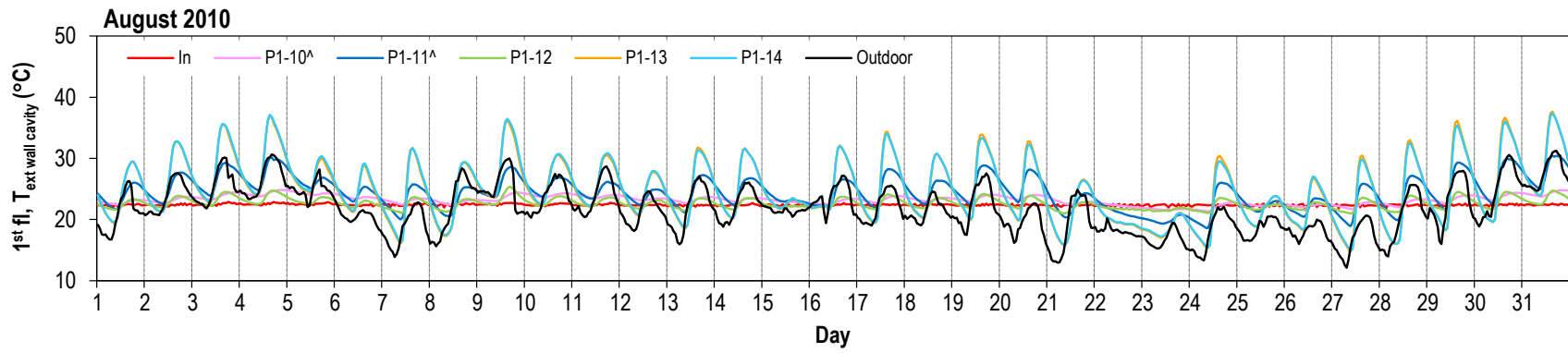
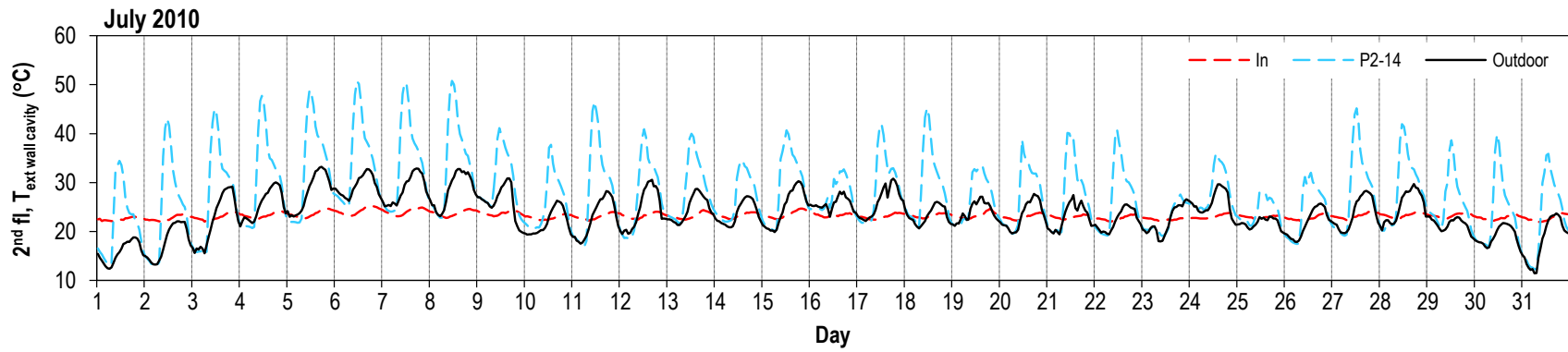

Temperature ($^{\circ}\text{C}$) at interior side of stud cavity. Refer to Figures 25 thru 28 for sensor location.

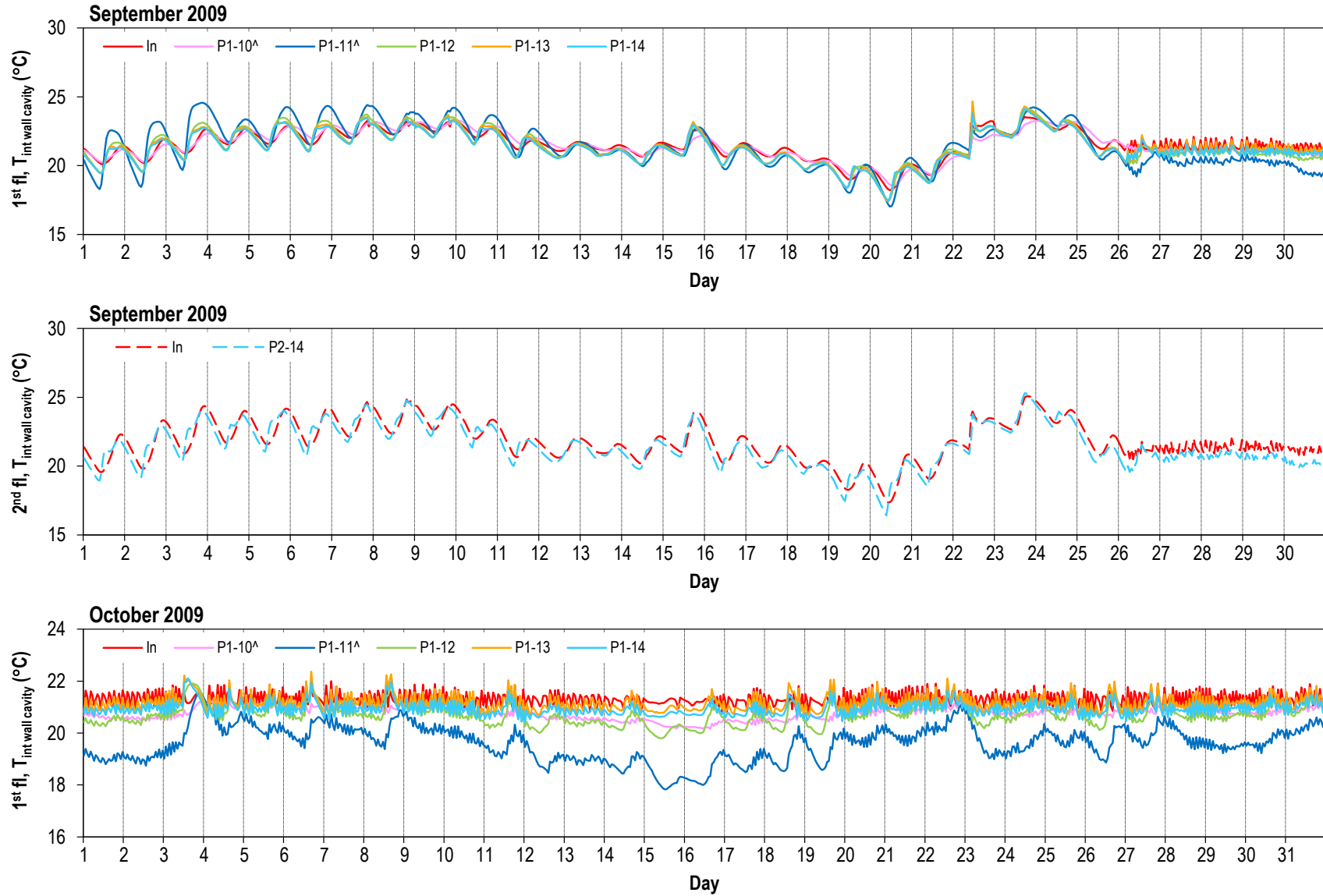

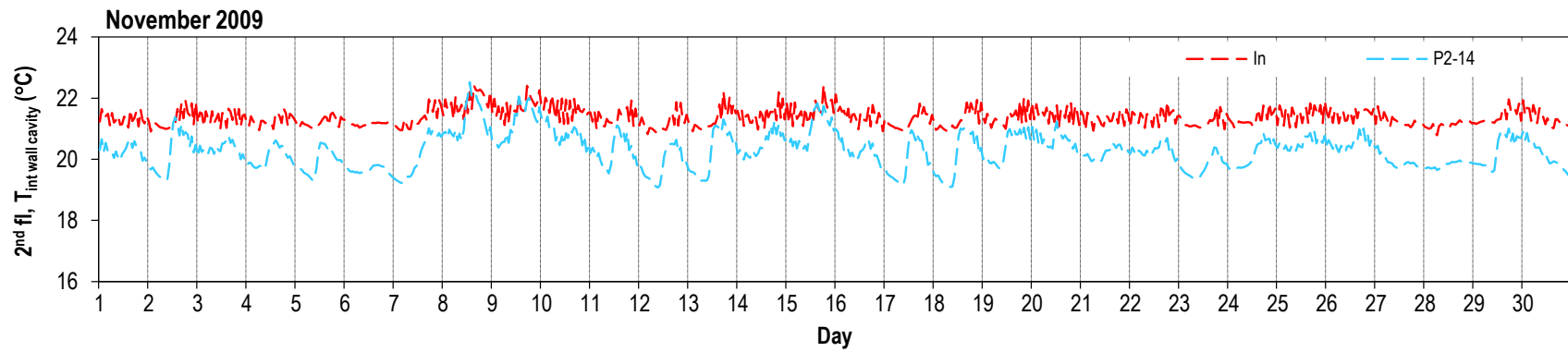
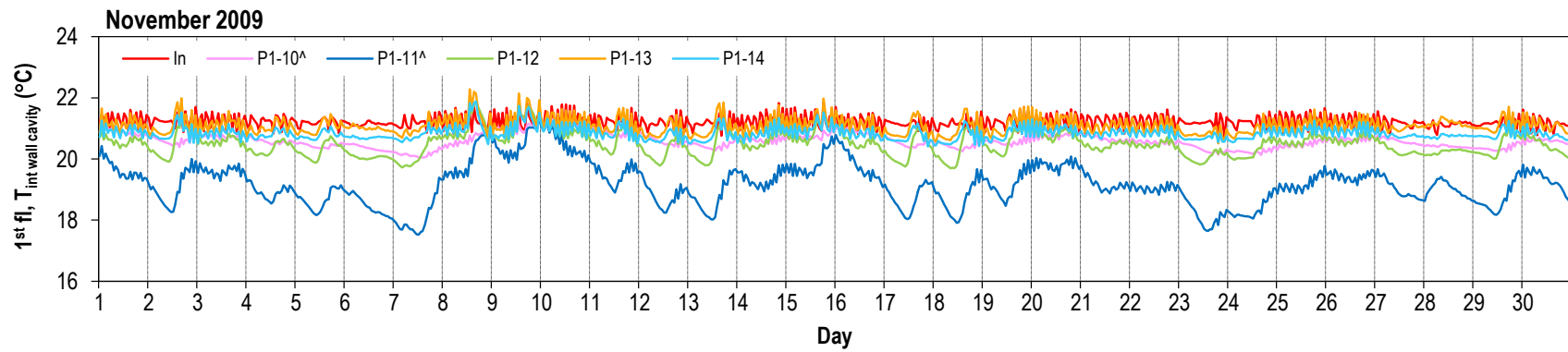
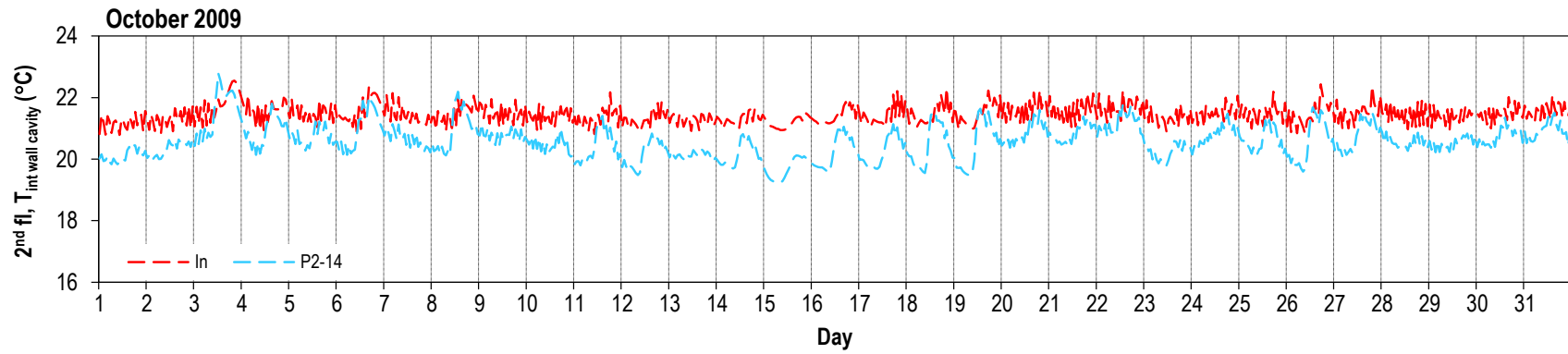

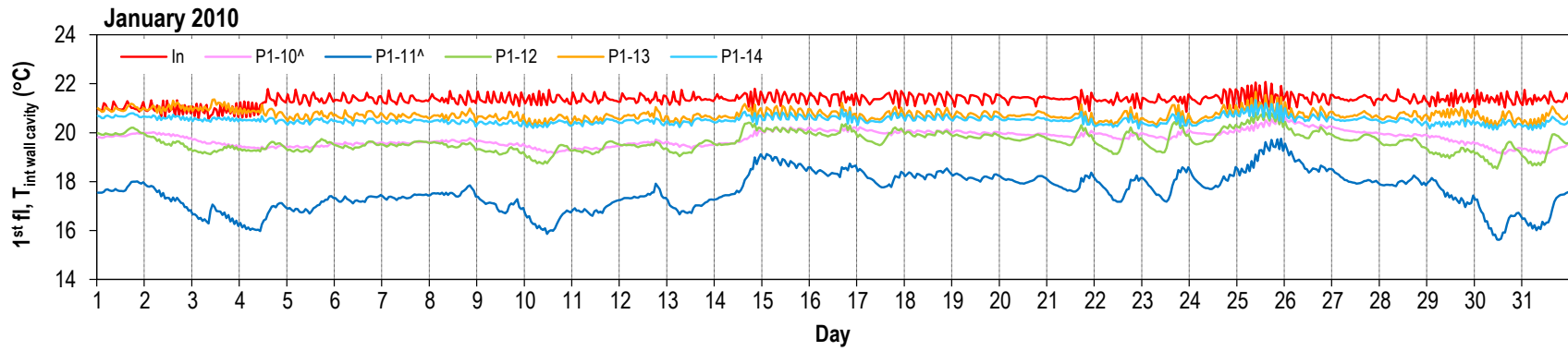
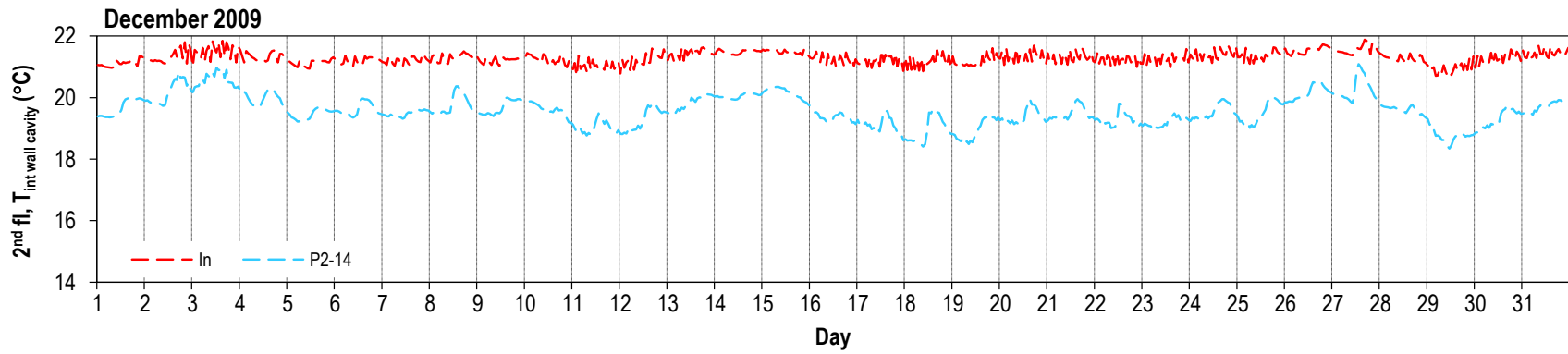
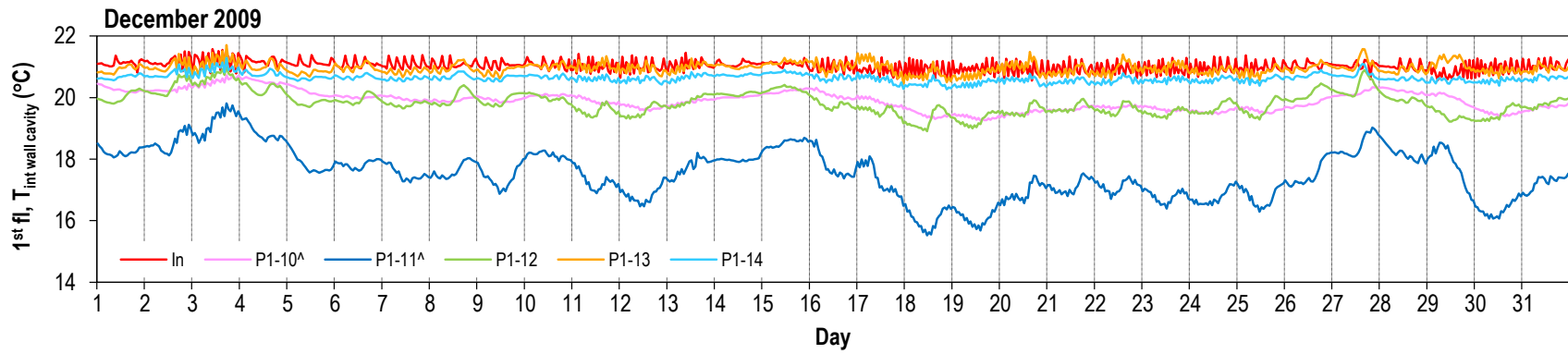

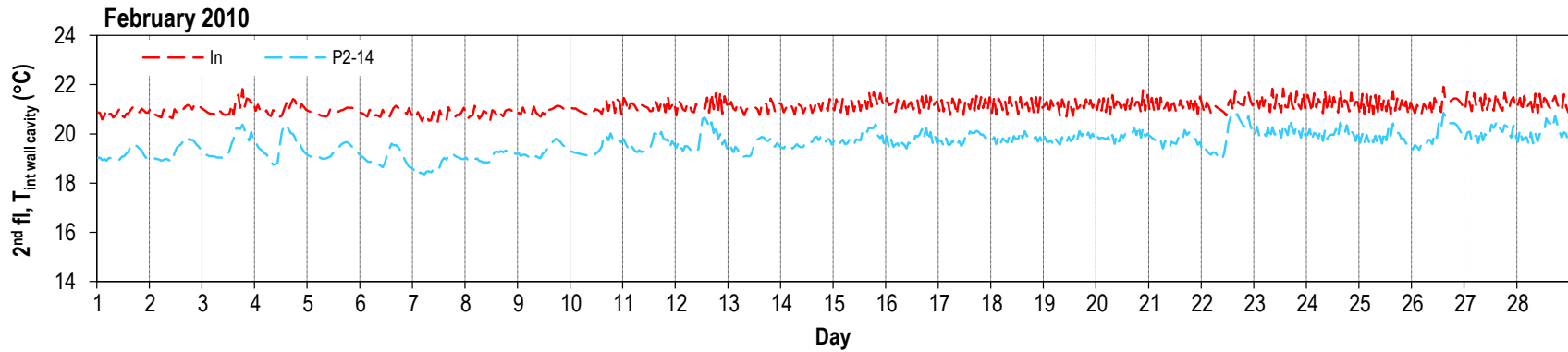
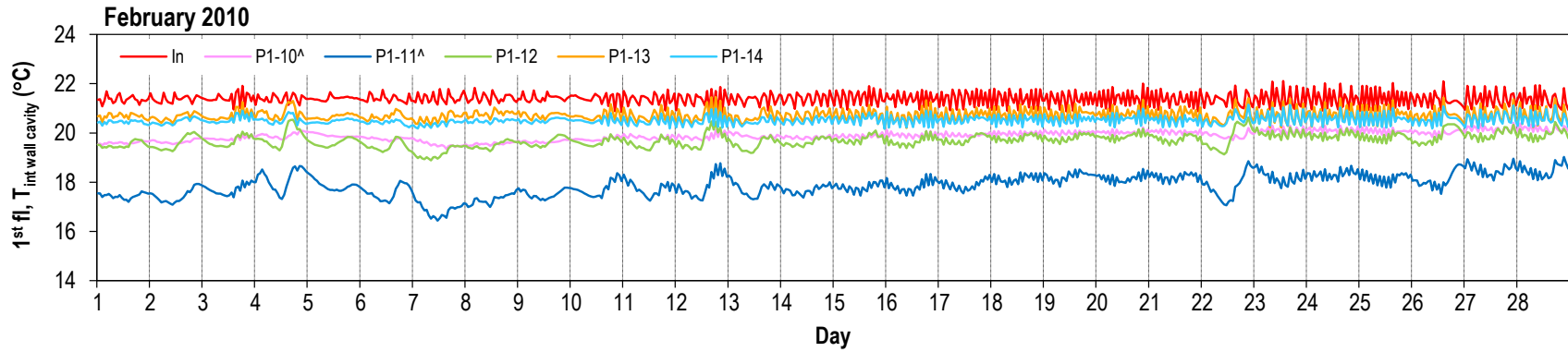
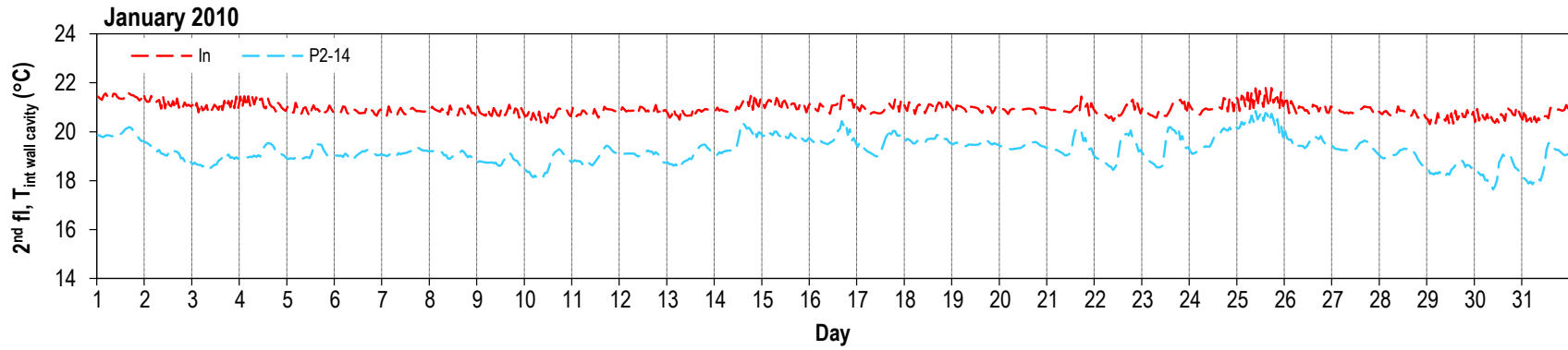

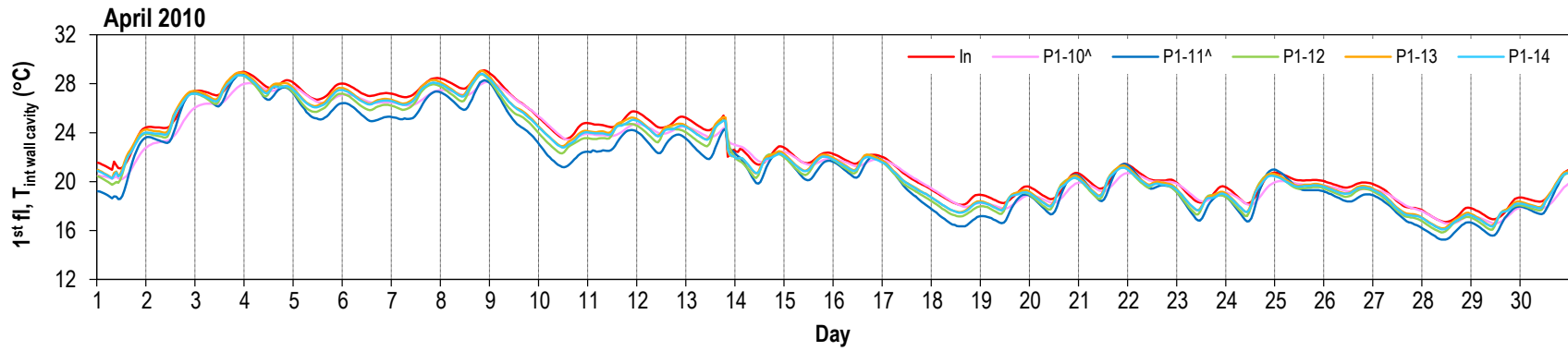
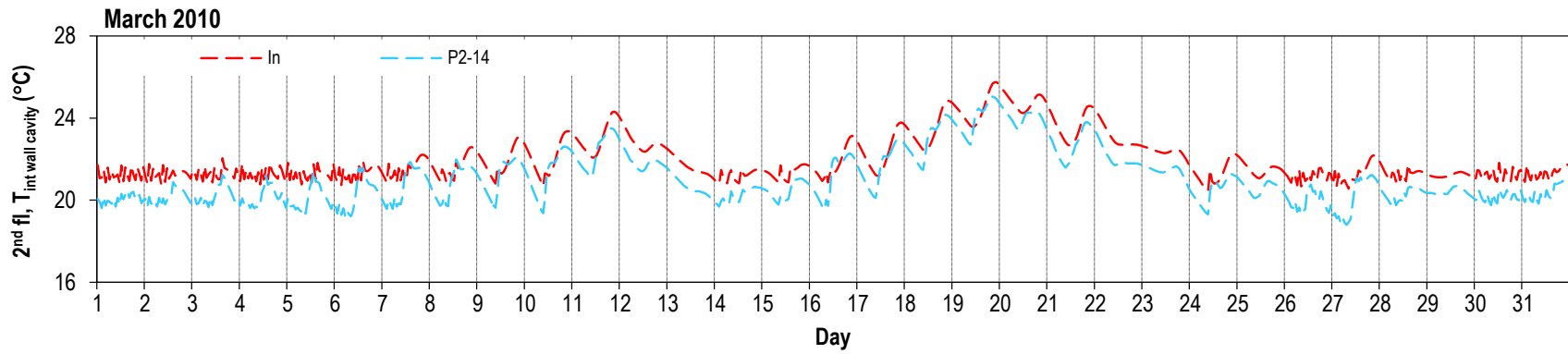
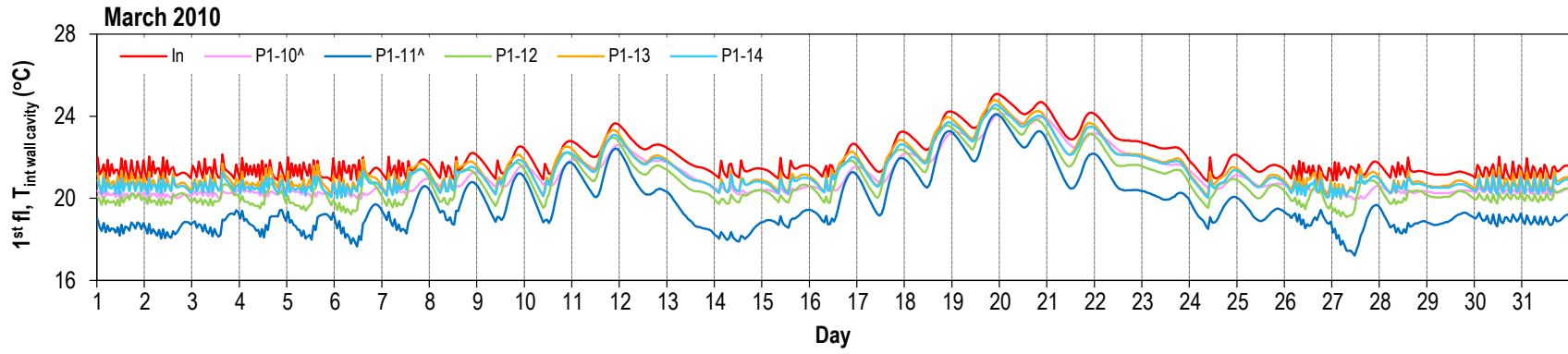

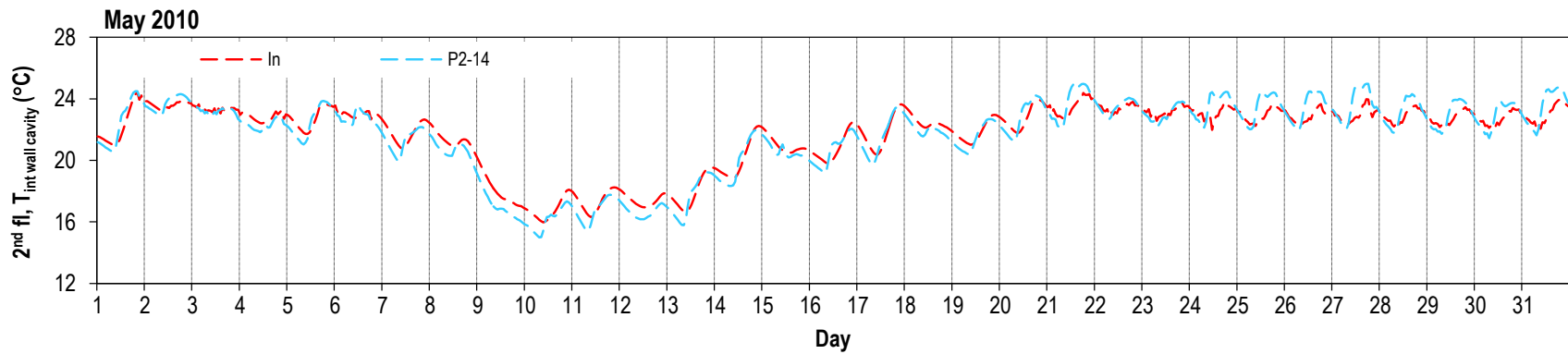
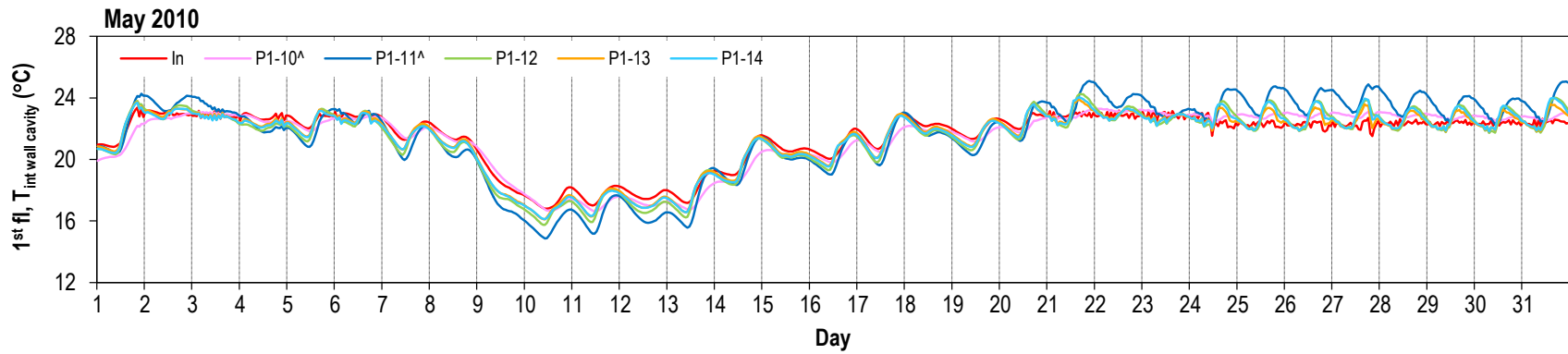
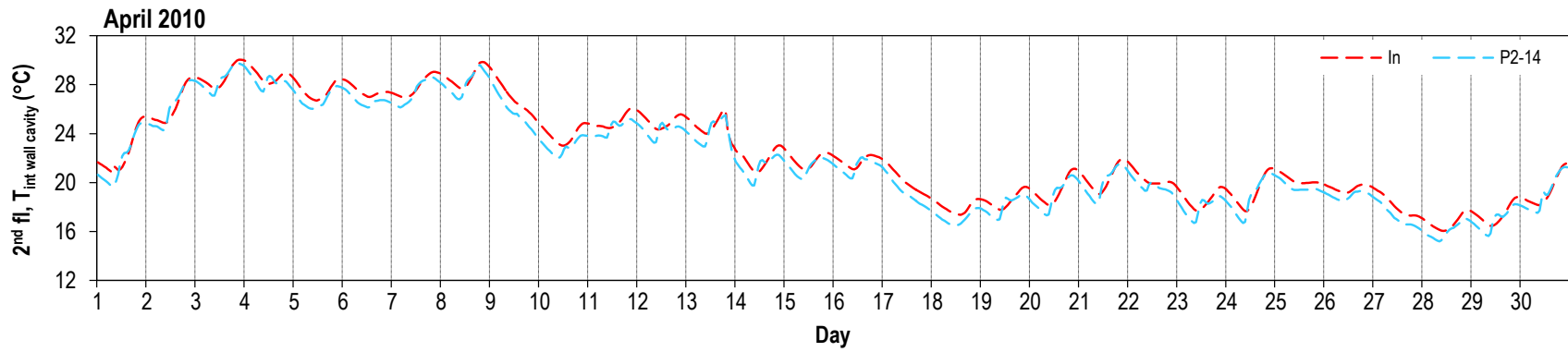

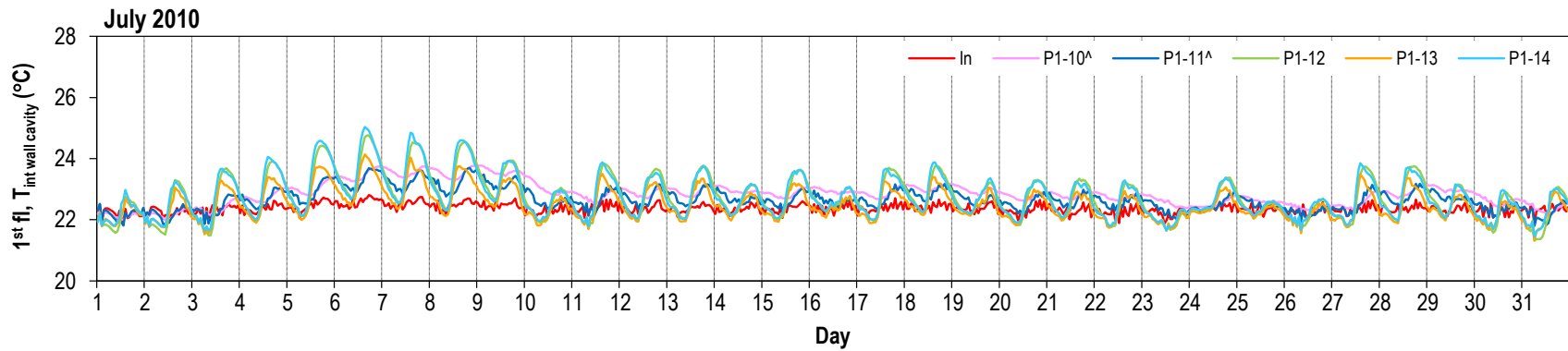
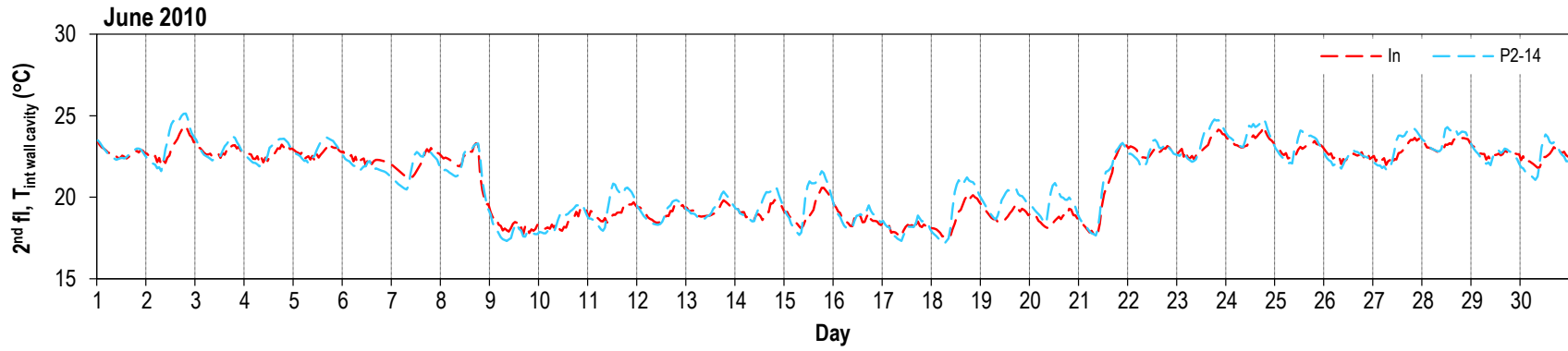
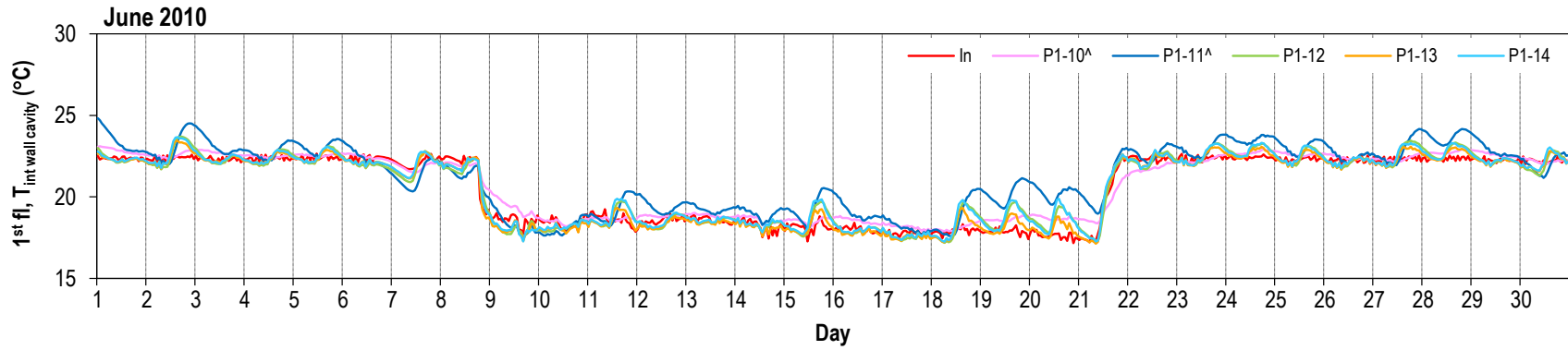

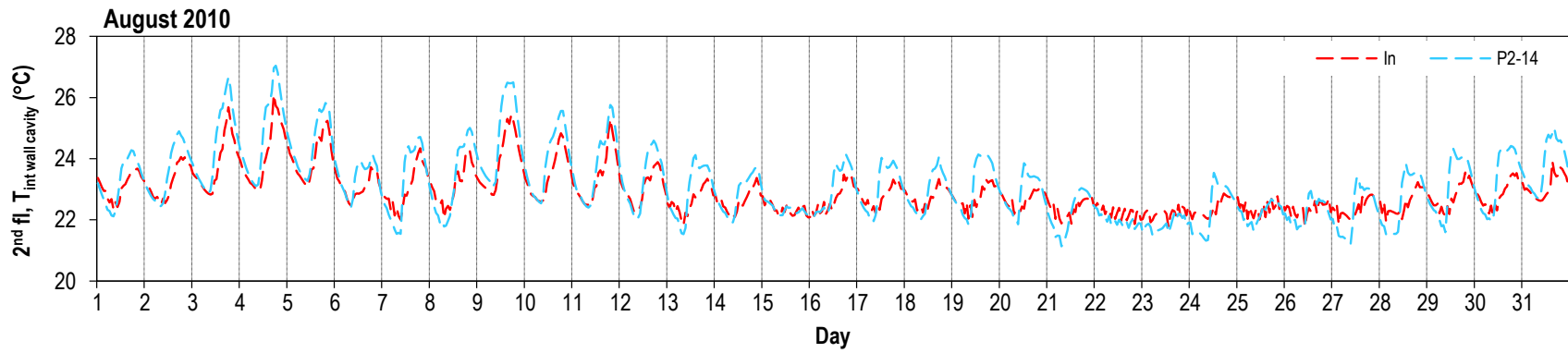
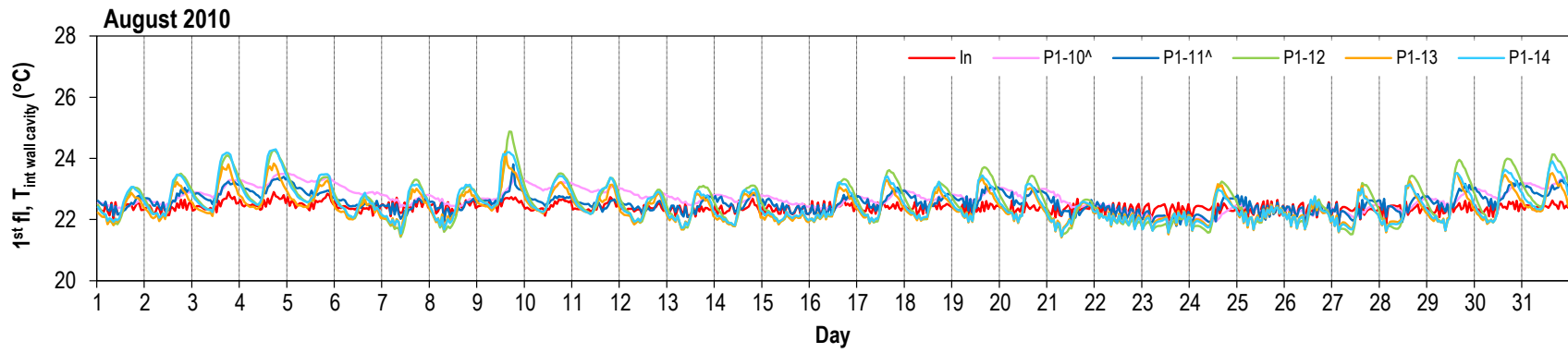
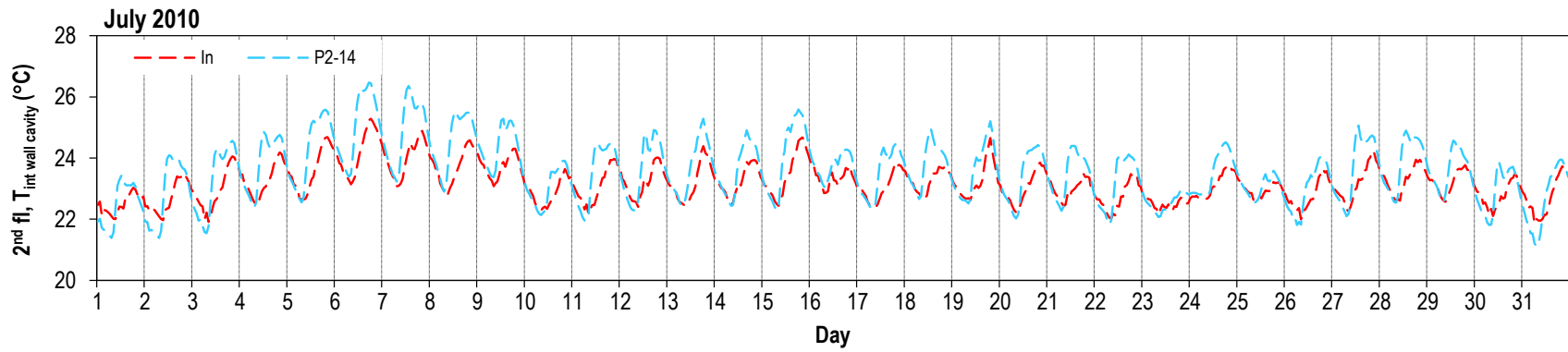

Relative humidity (%) at exterior side of stud cavity. Refer to Figures 25 thru 28 for sensor location.

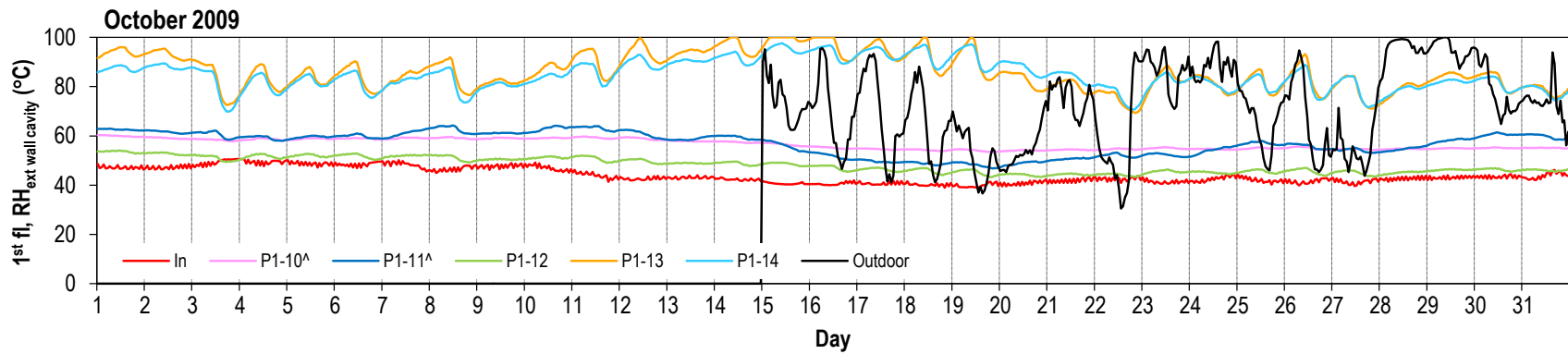
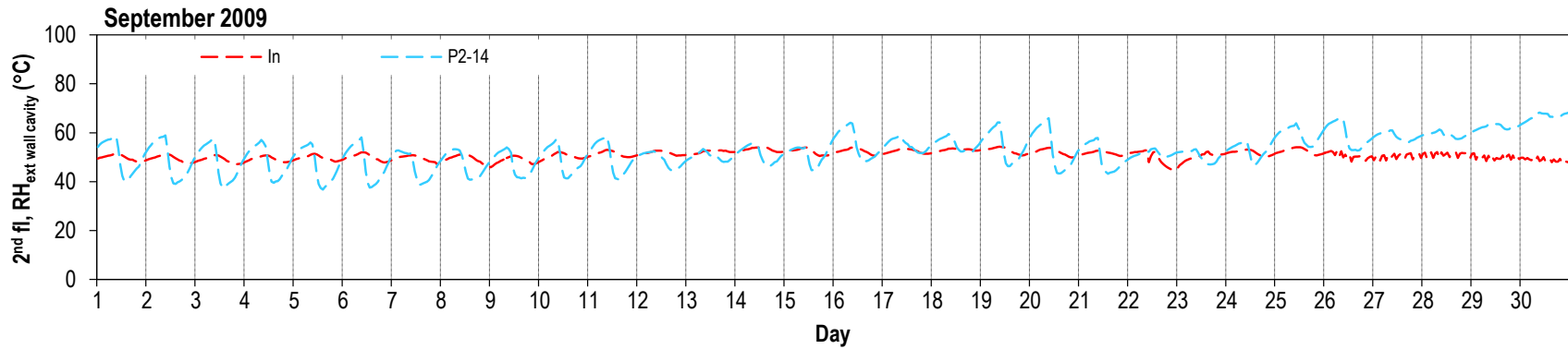
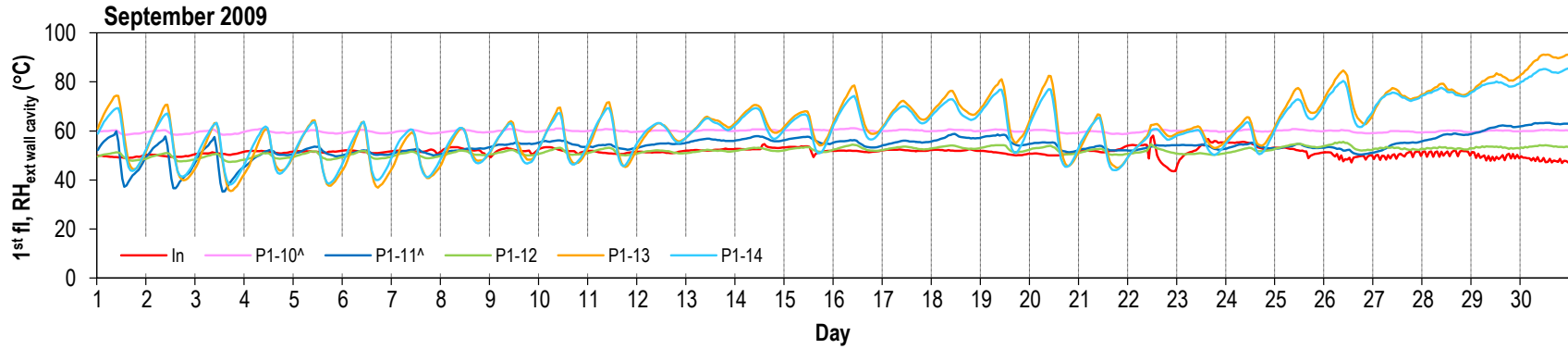

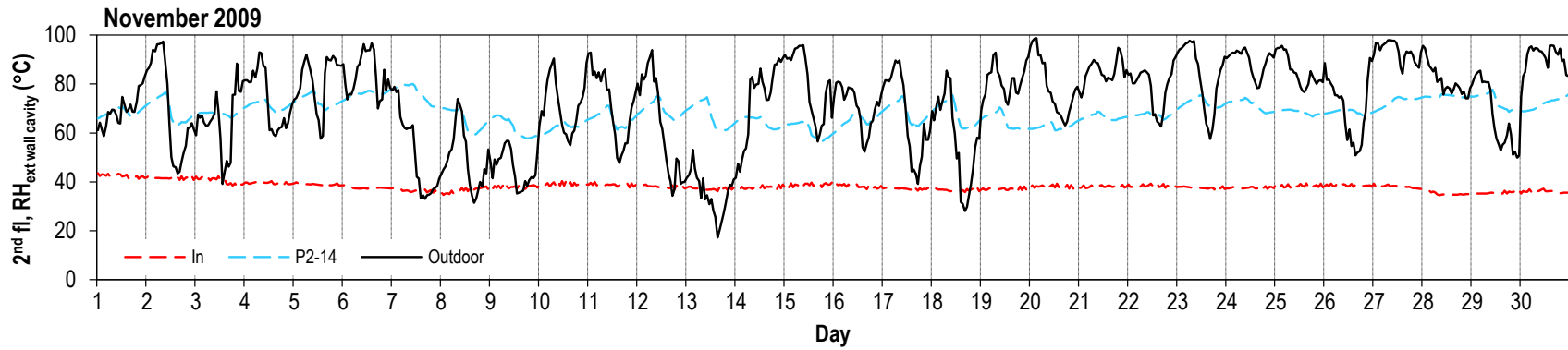
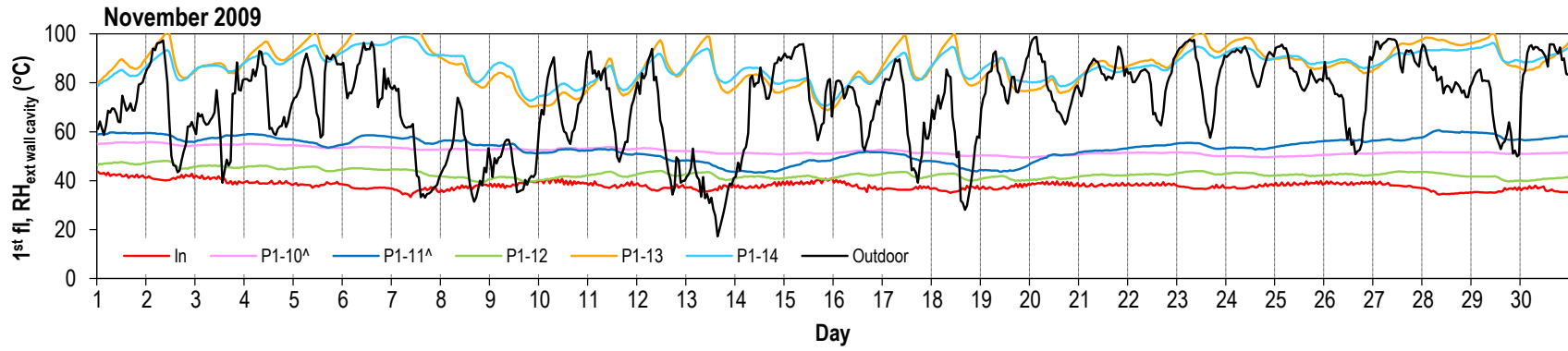
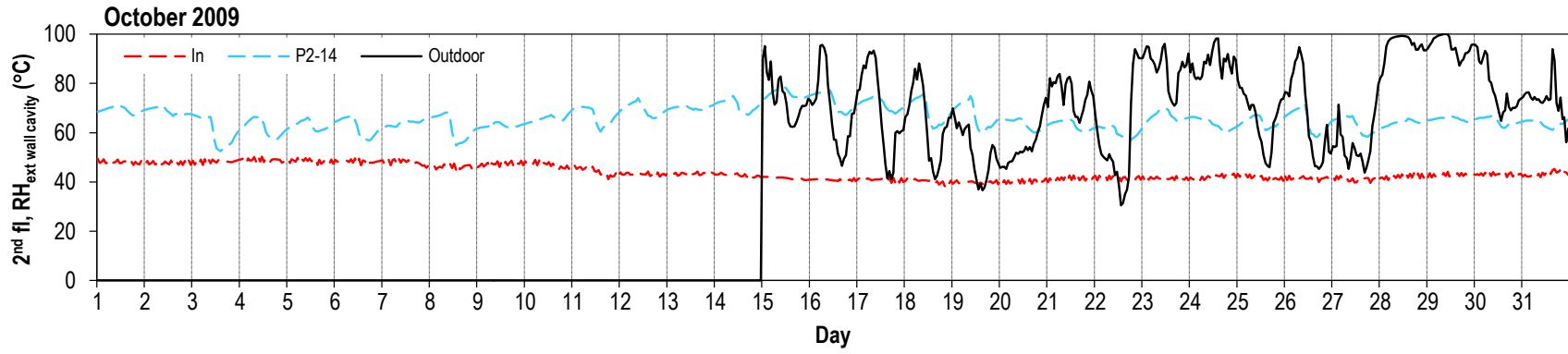

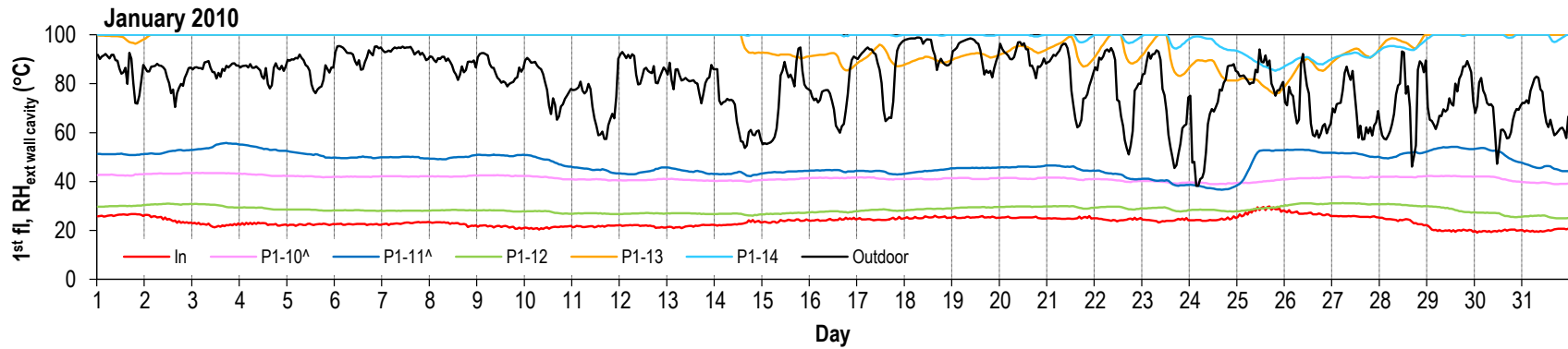
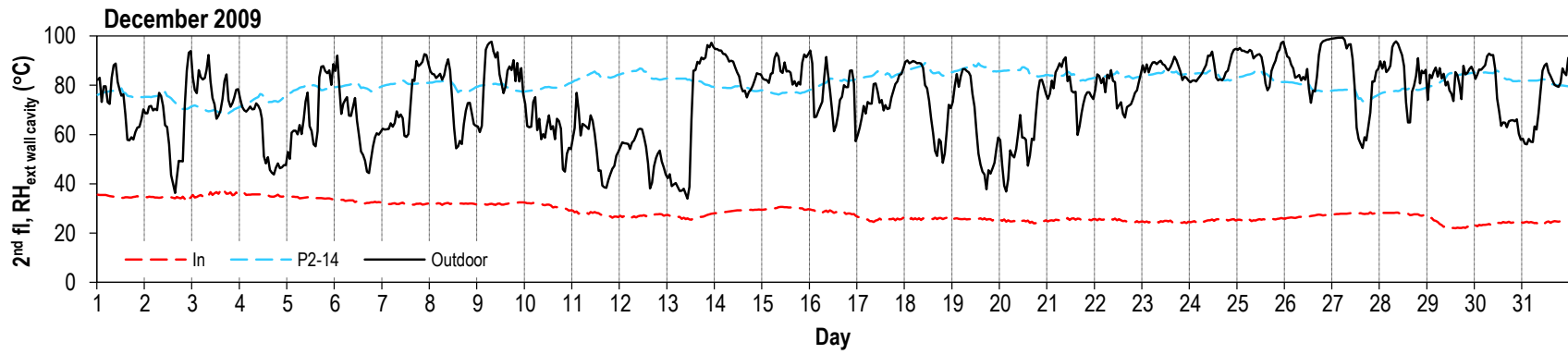
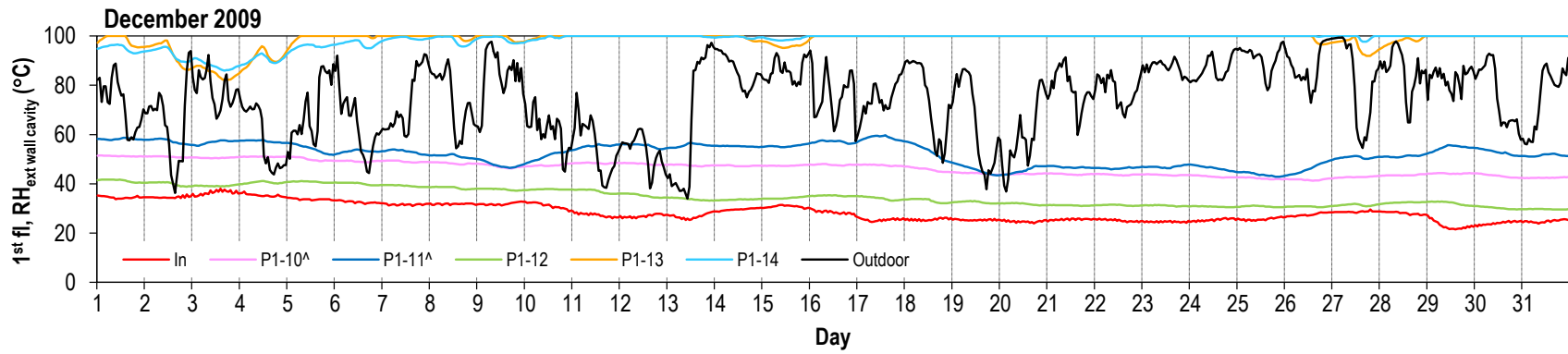

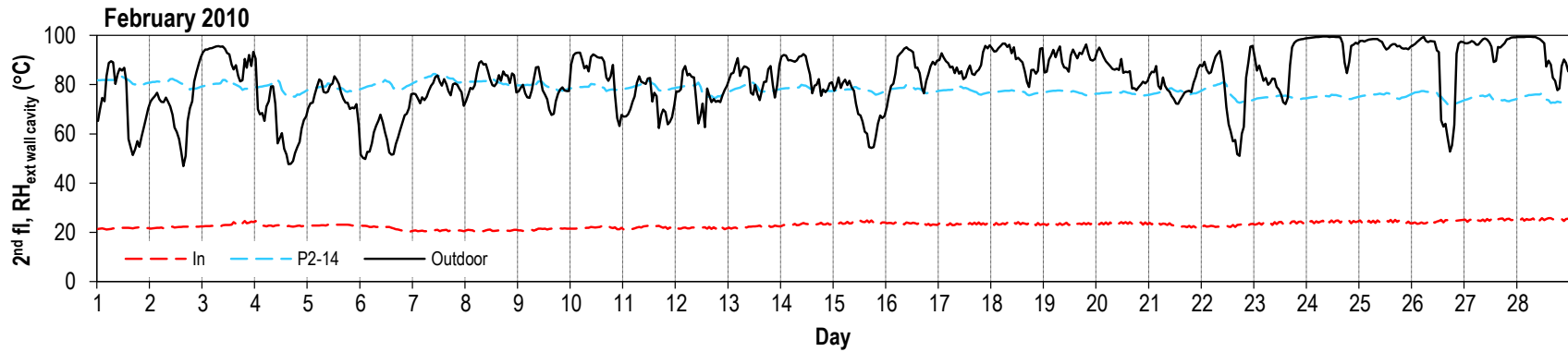
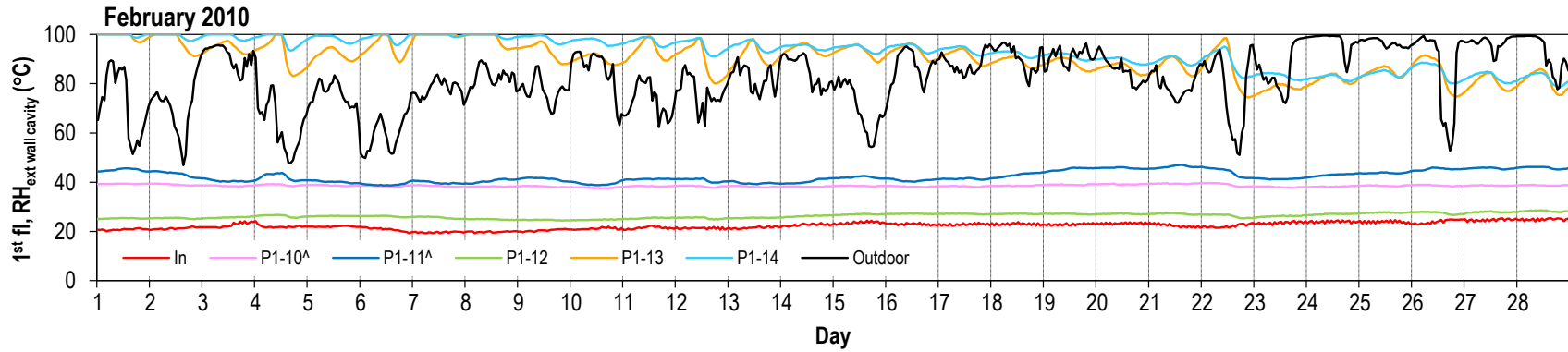
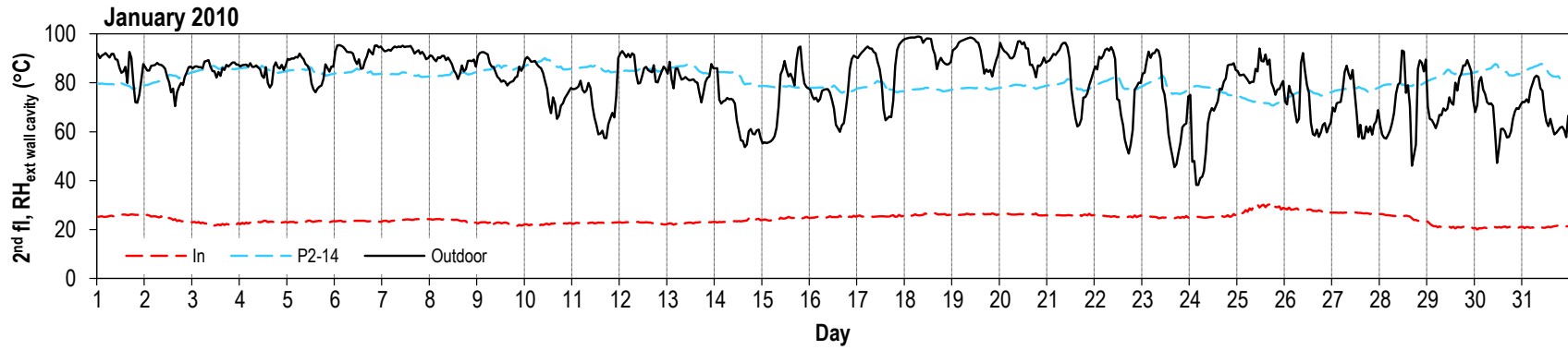

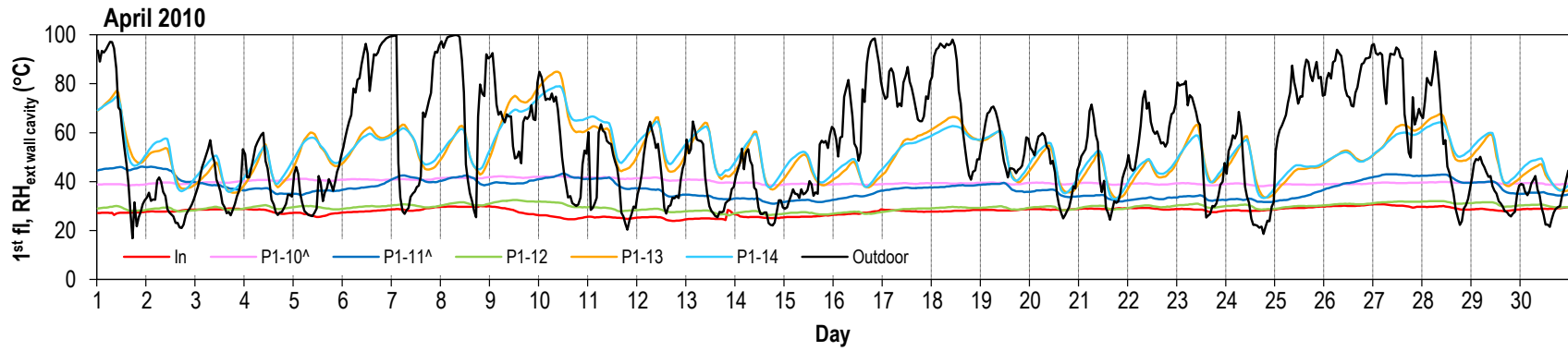
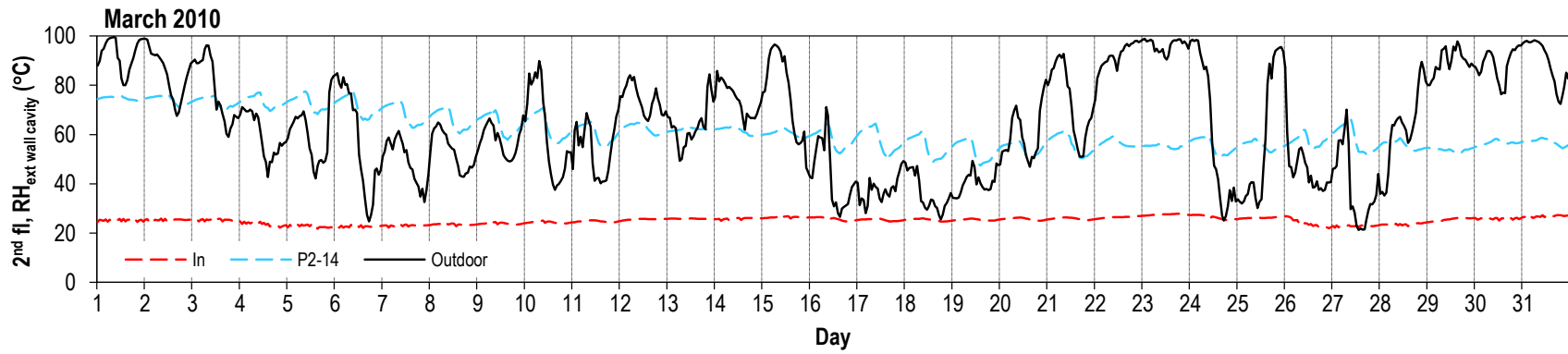
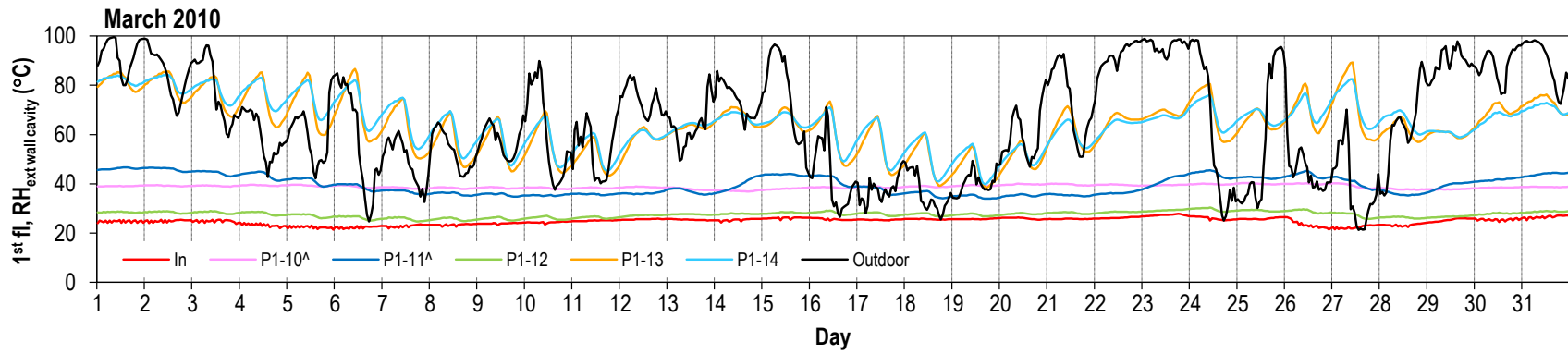

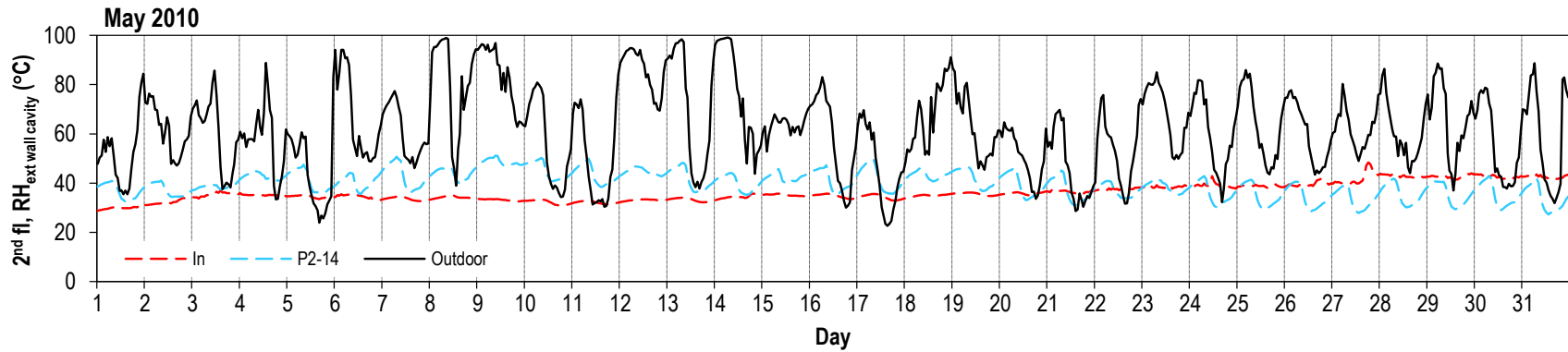
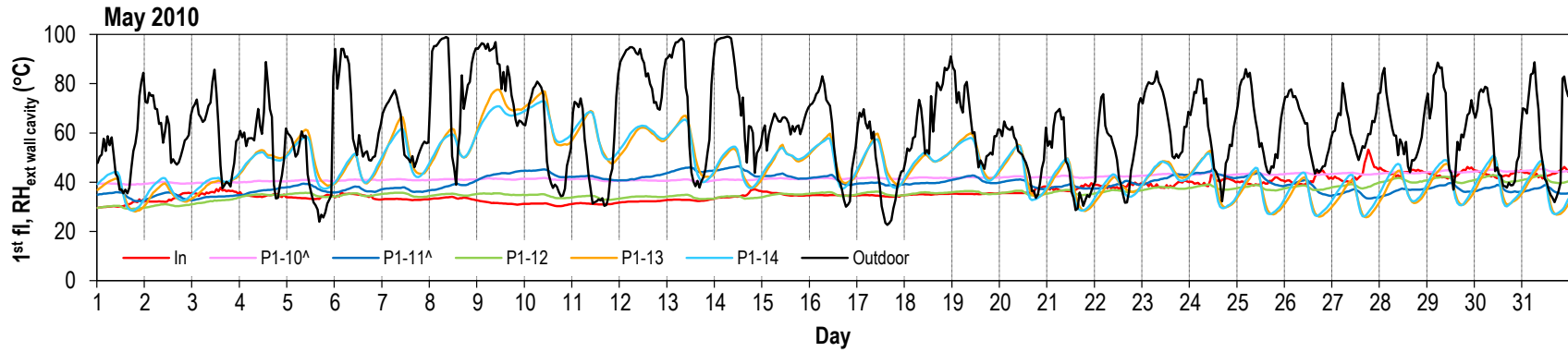
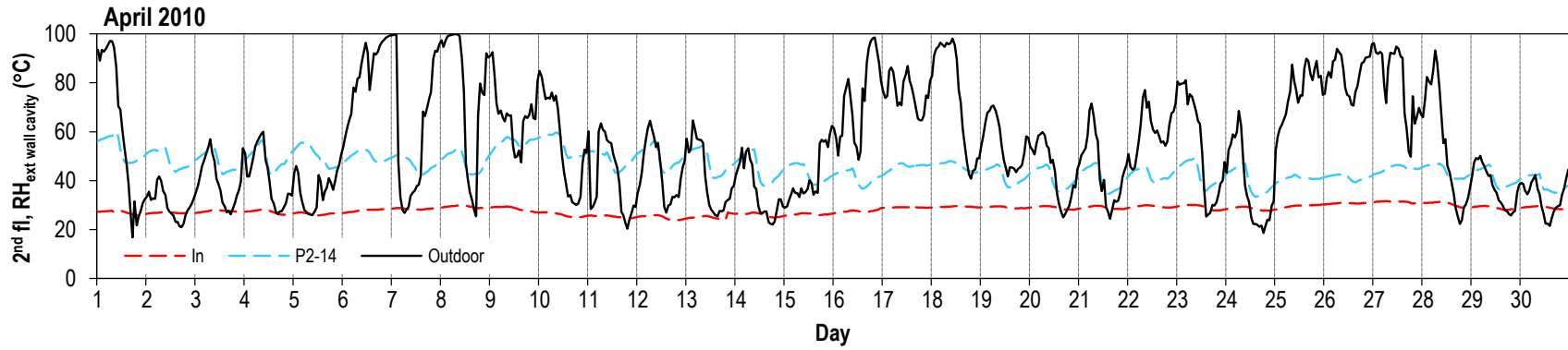

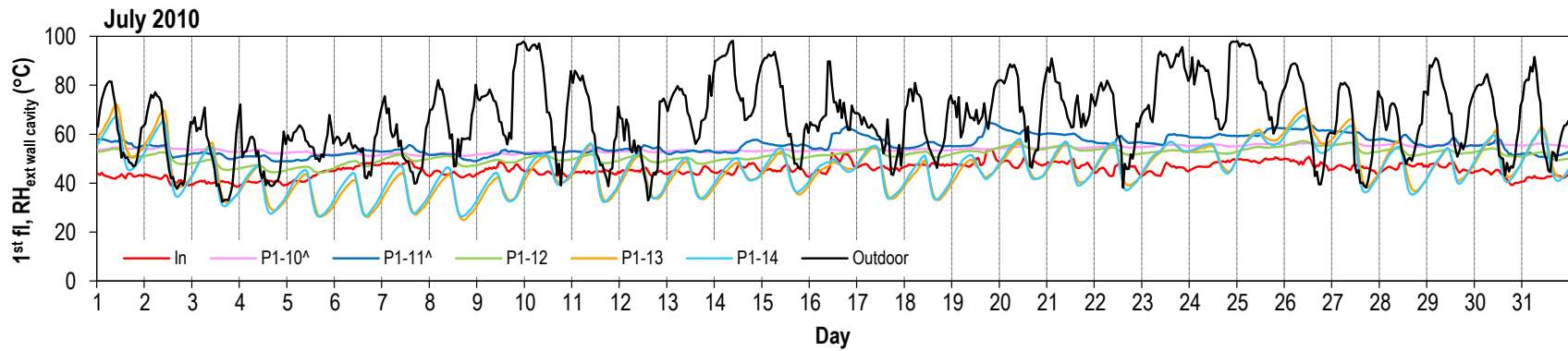
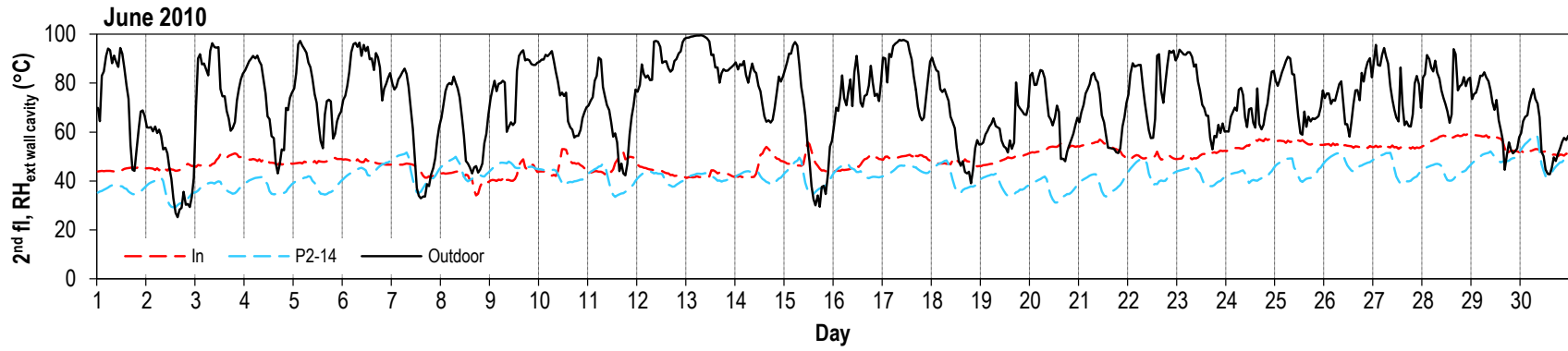
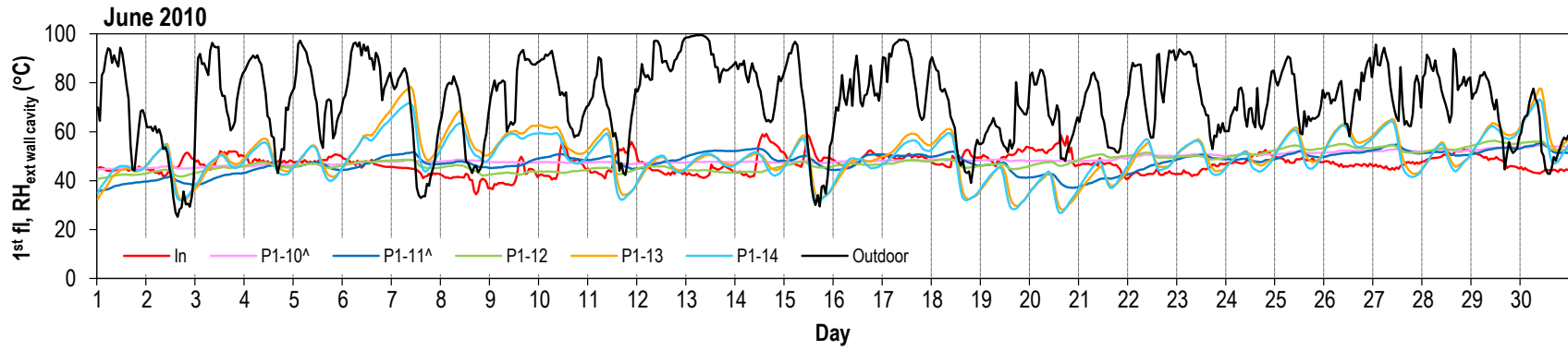

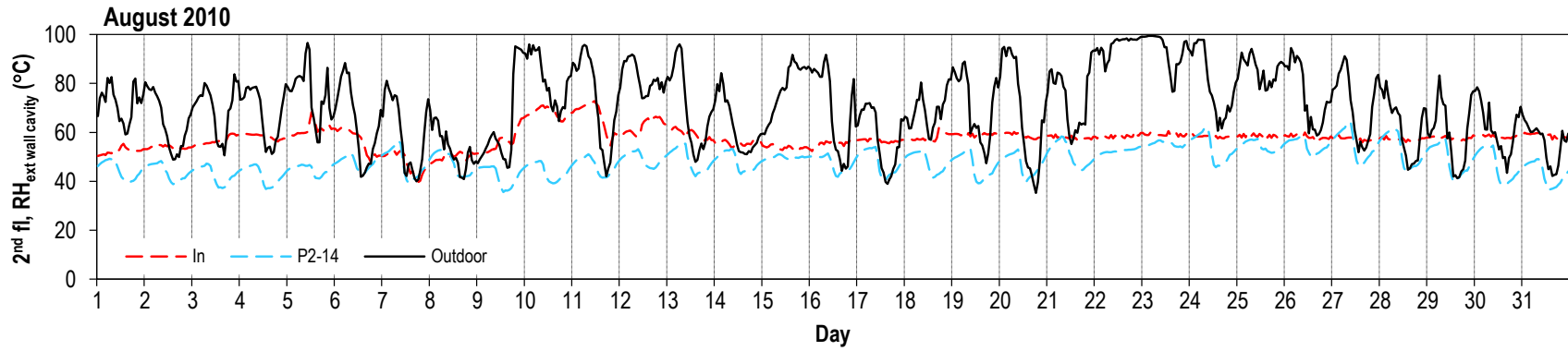
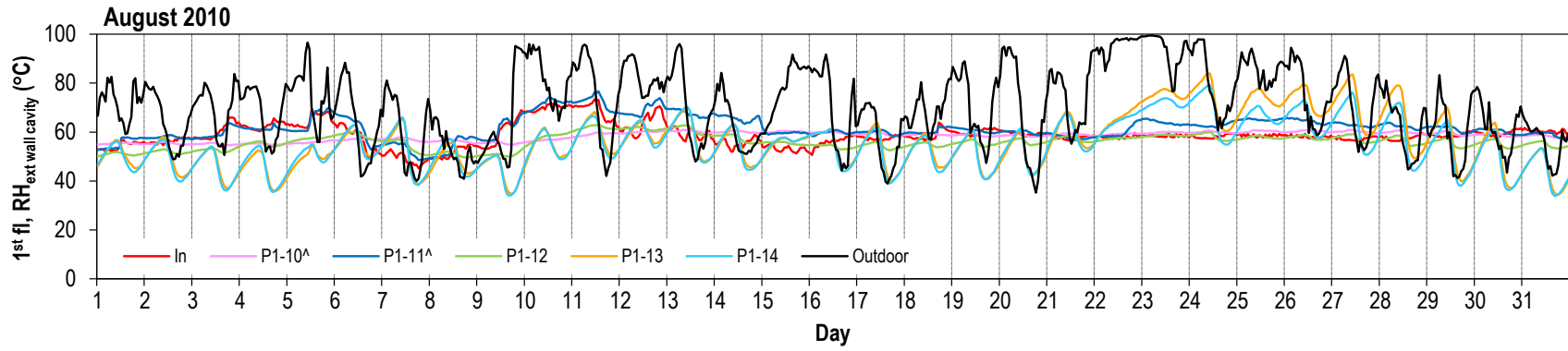
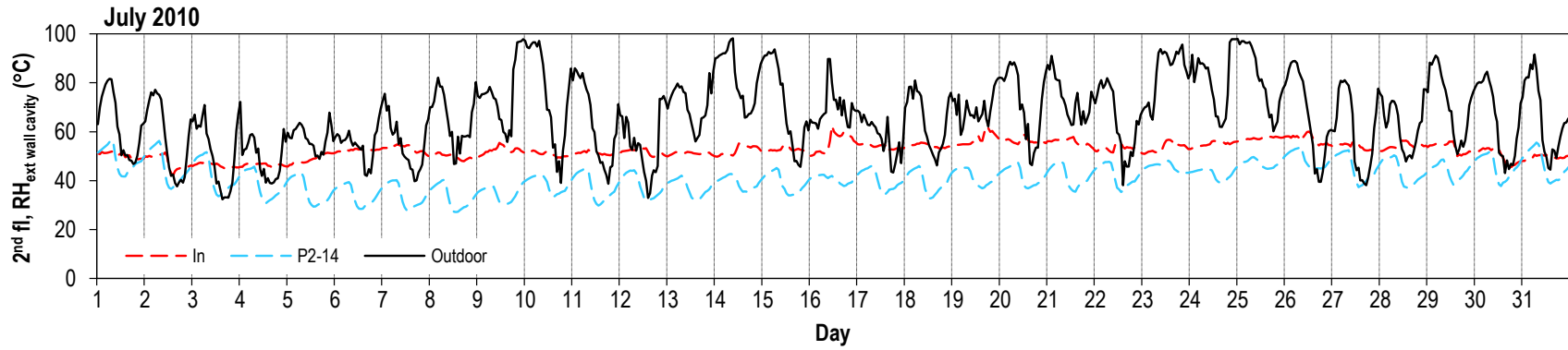

Water vapor pressure (kPa) at exterior side of stud cavity. Refer to Figures 25 thru 28 for sensor location.

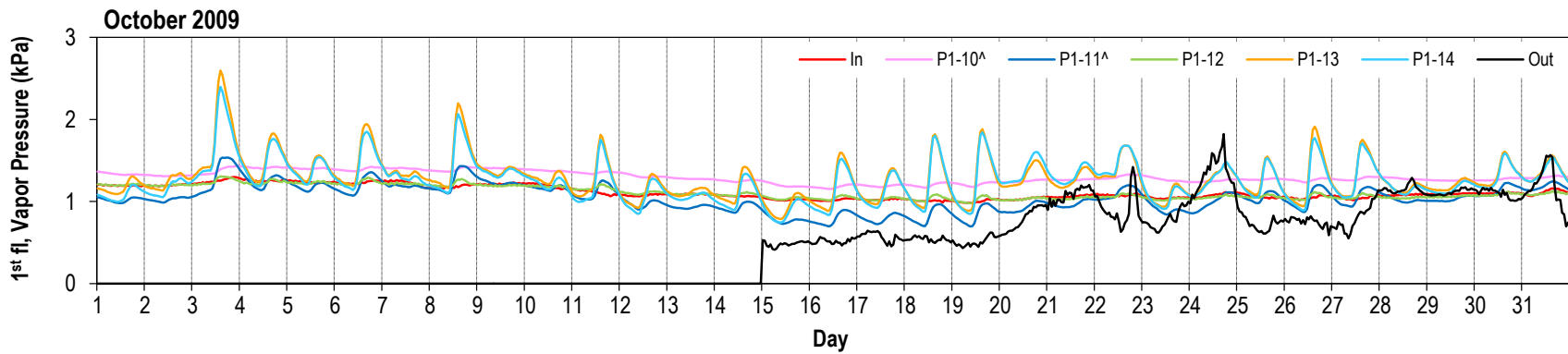
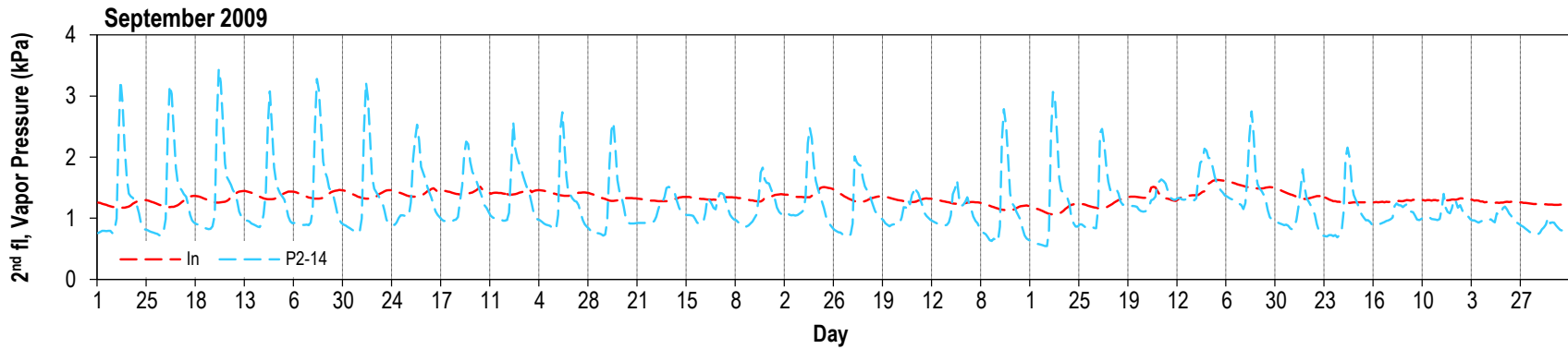
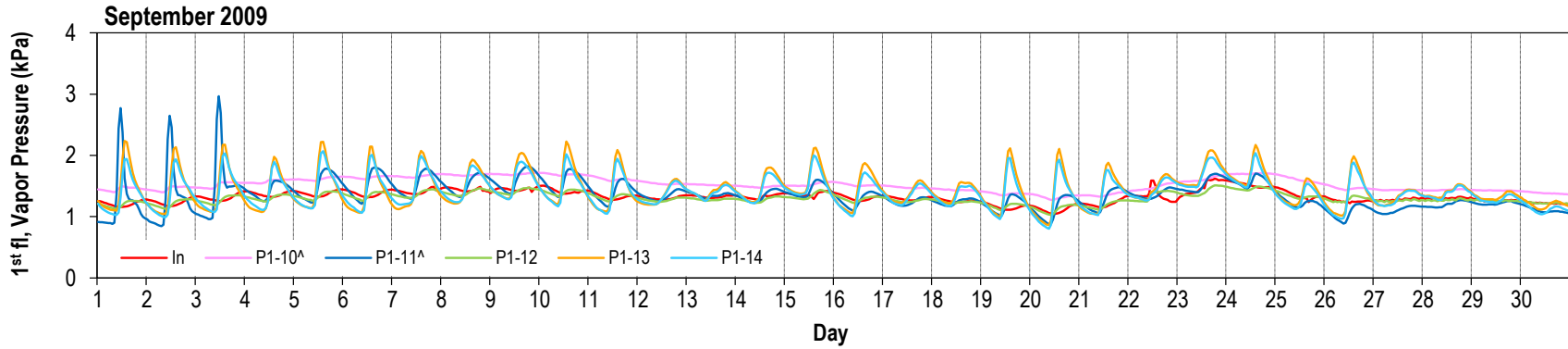

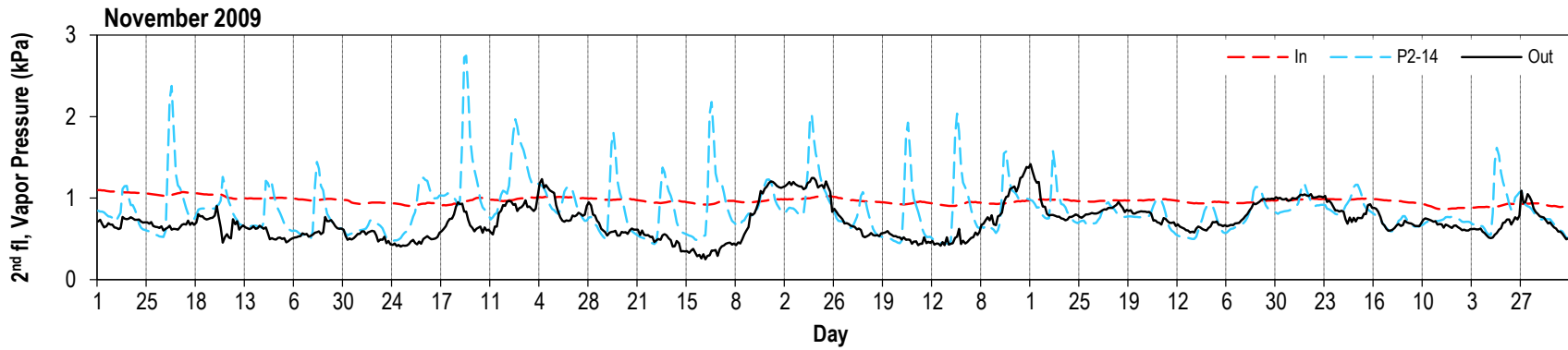
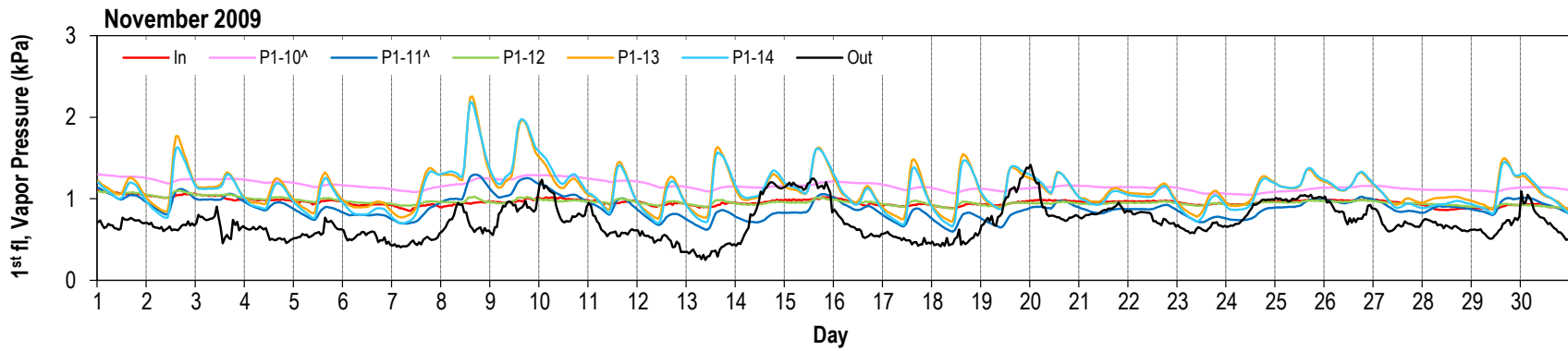
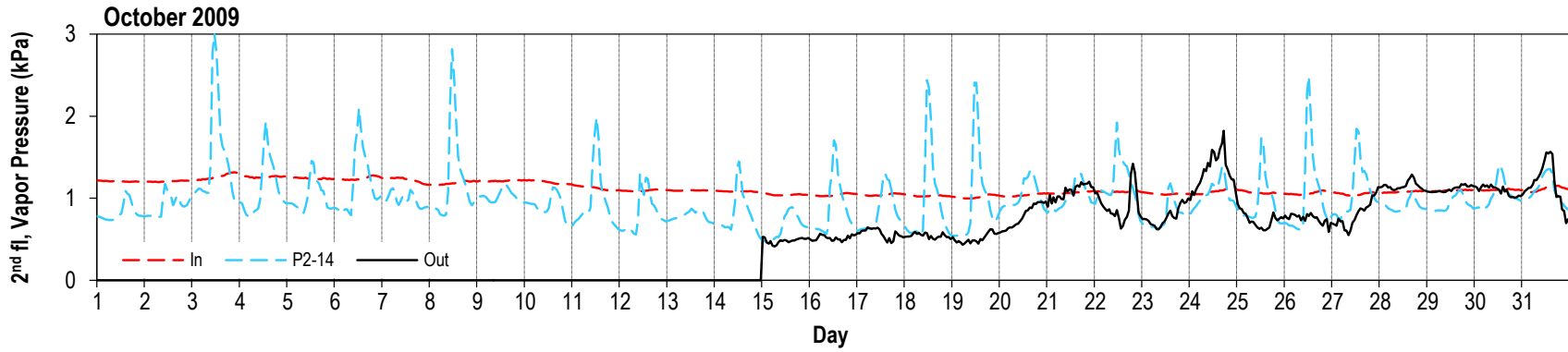

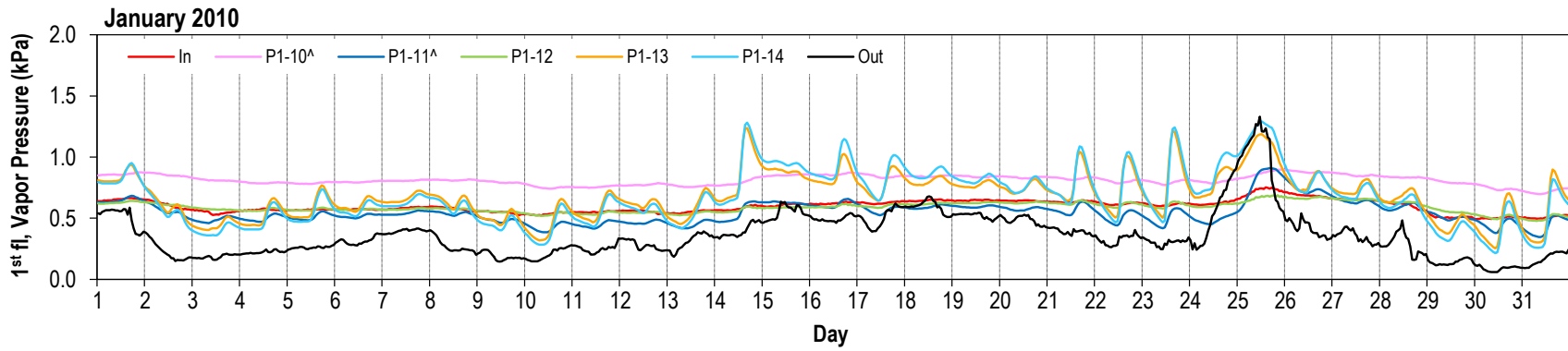
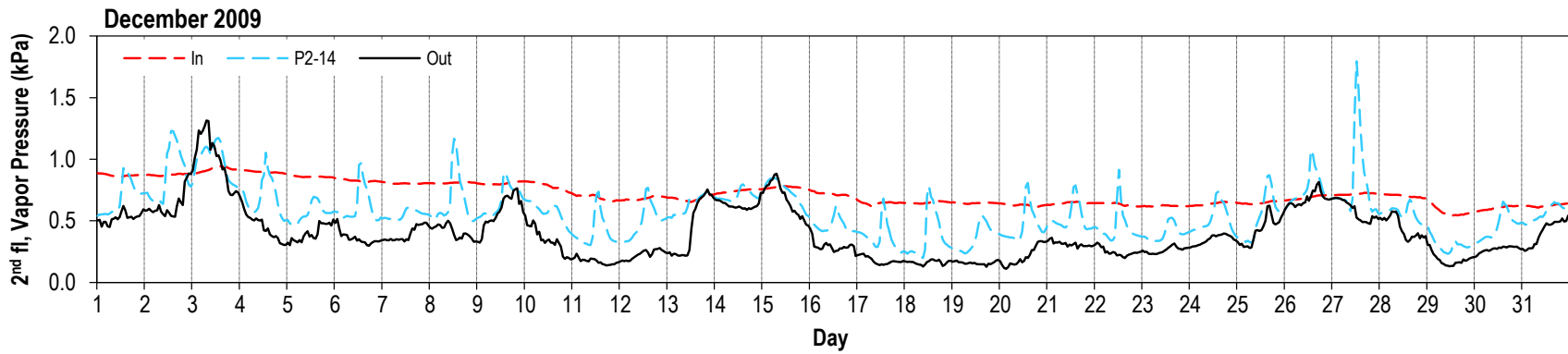
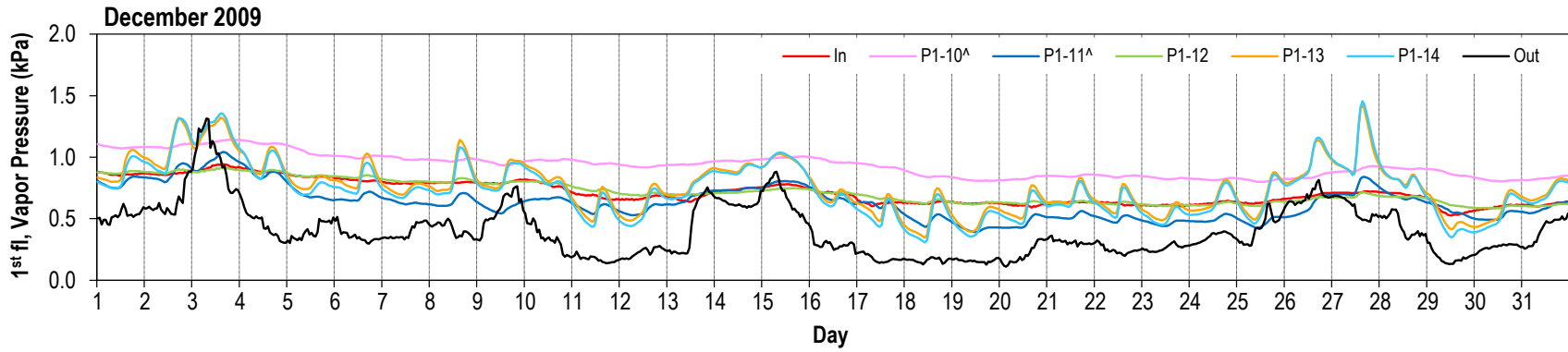

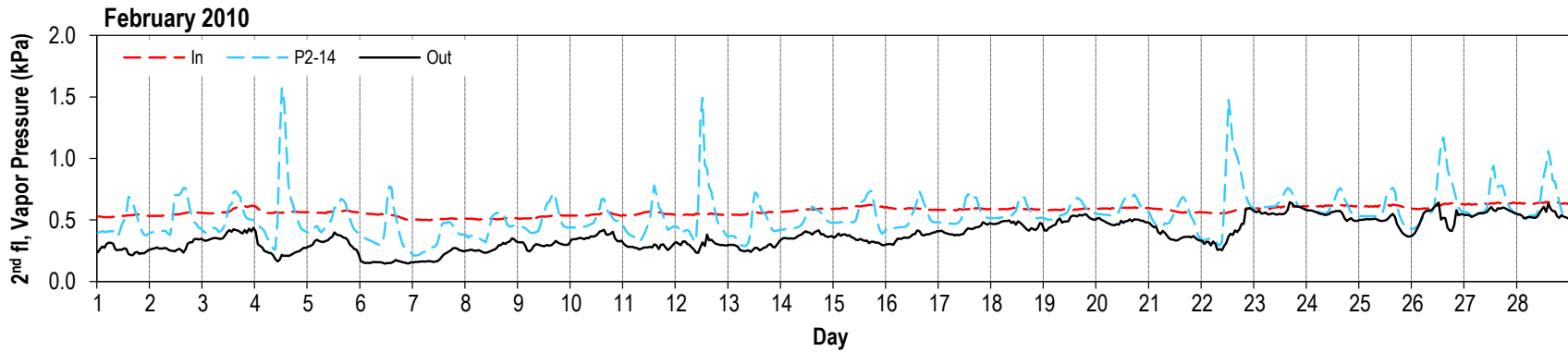
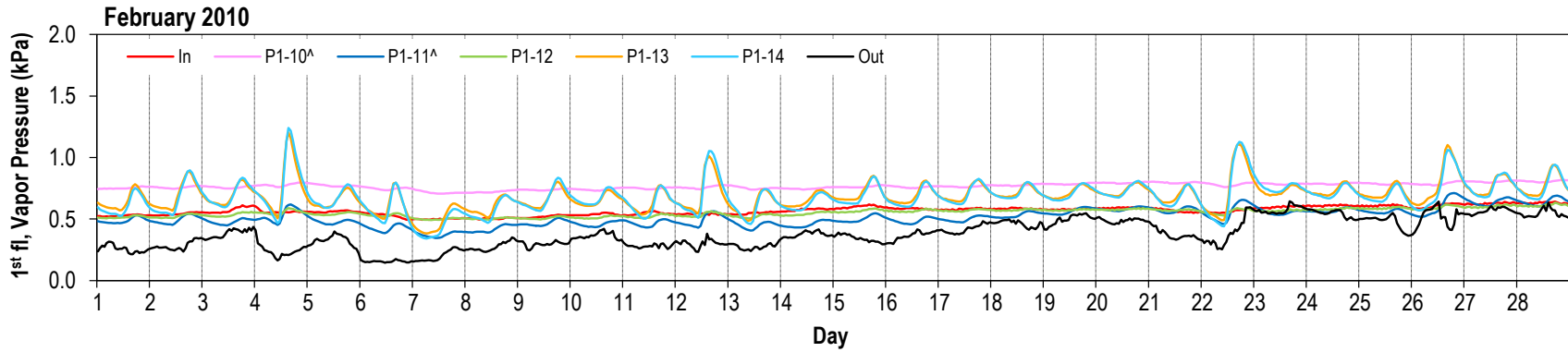
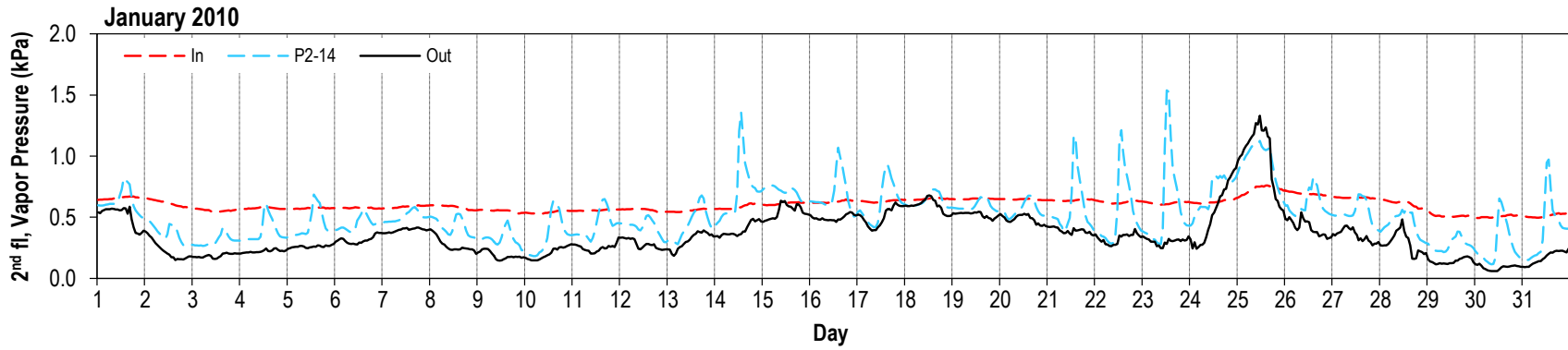

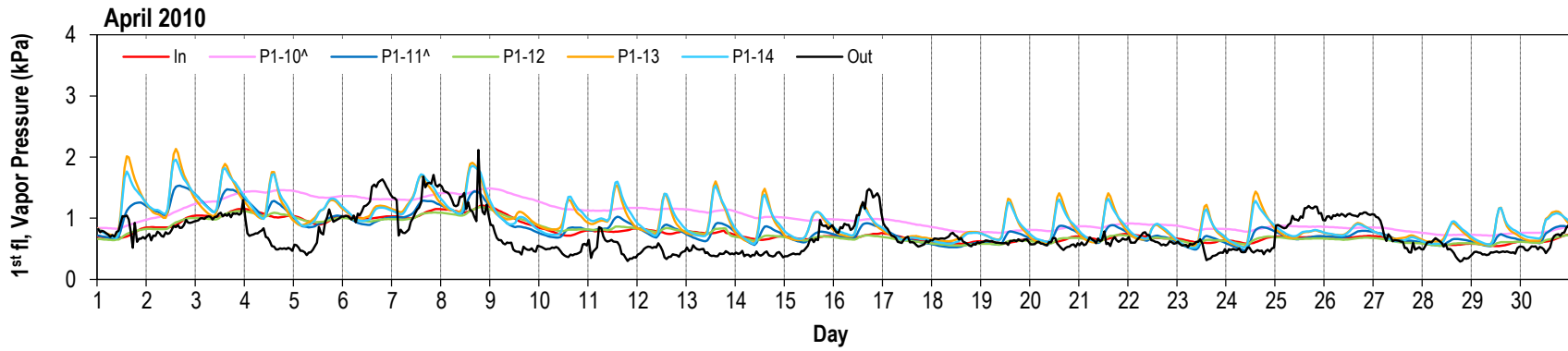
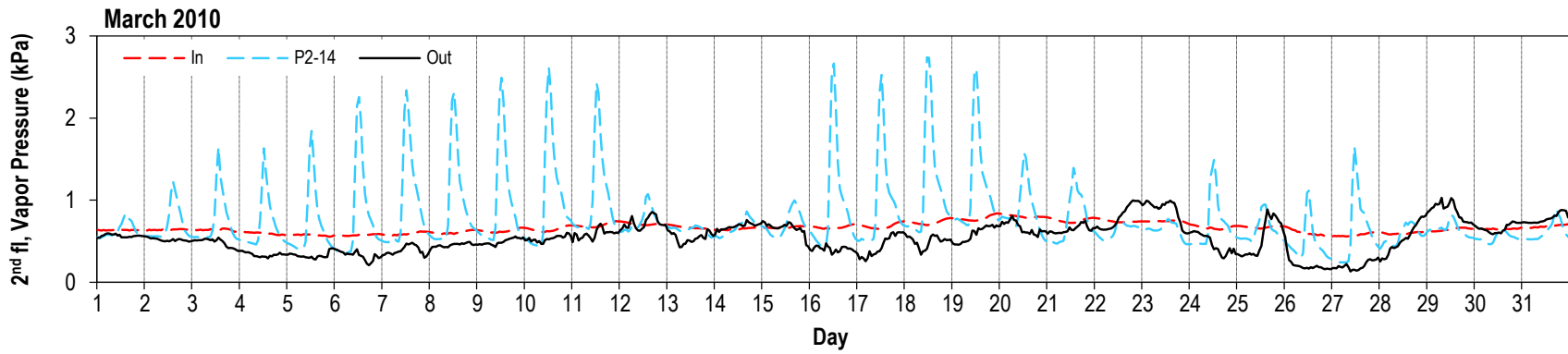
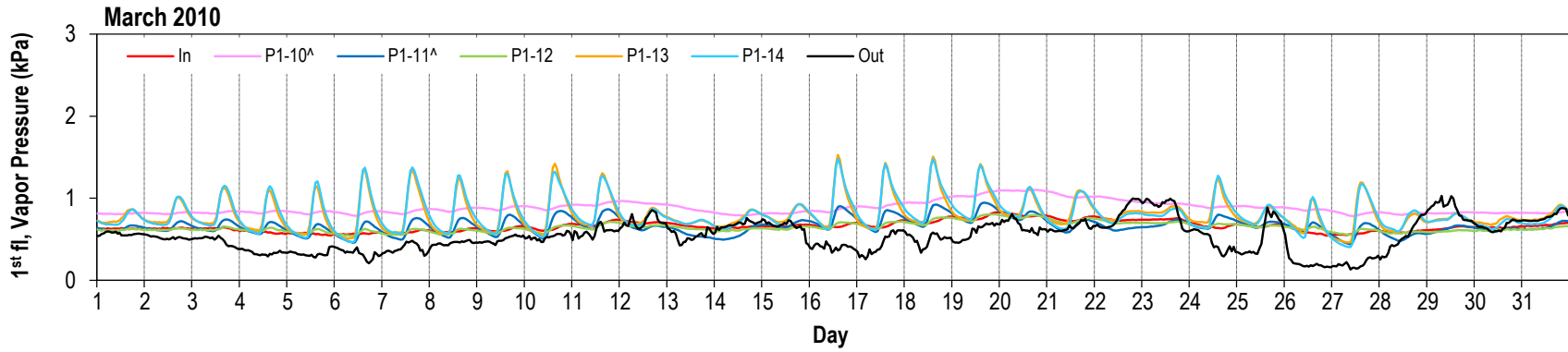

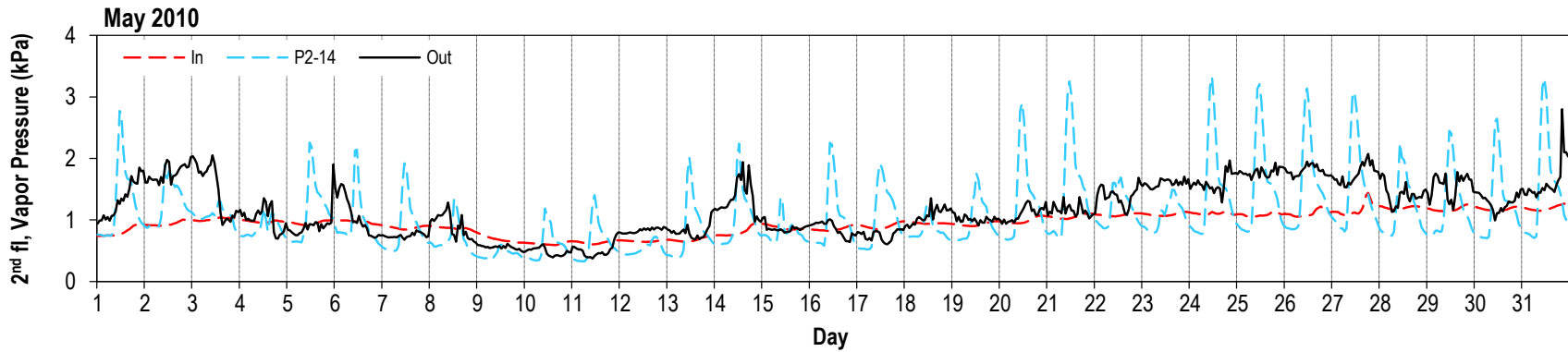
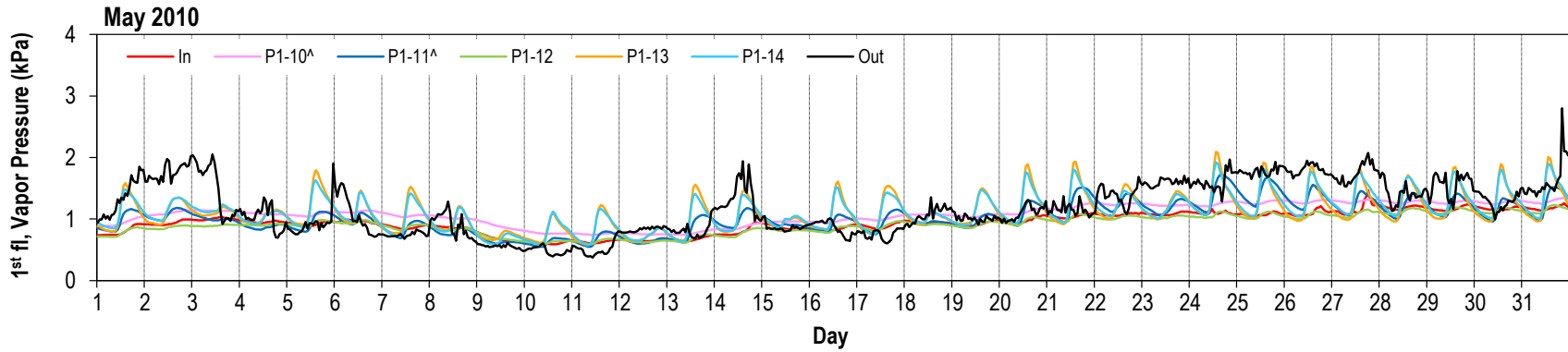
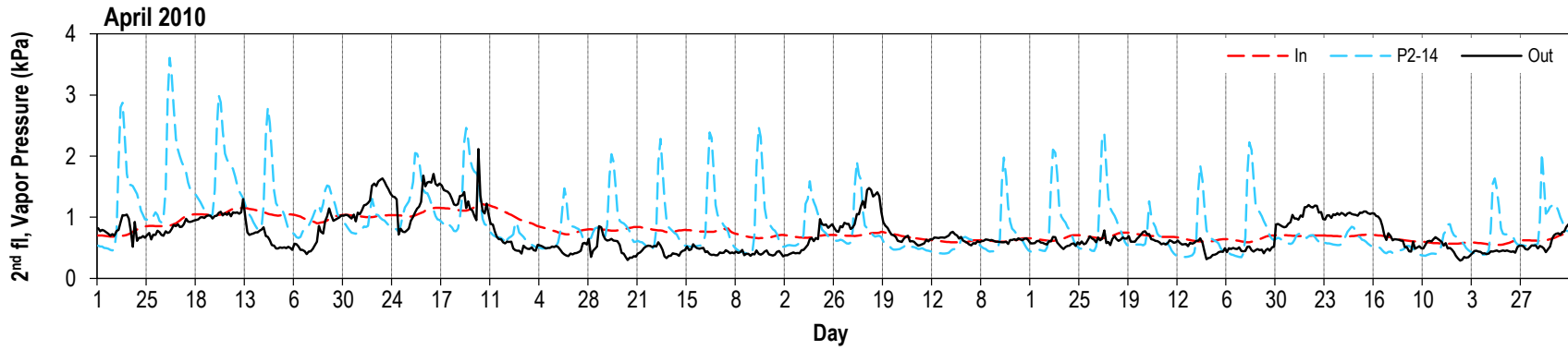

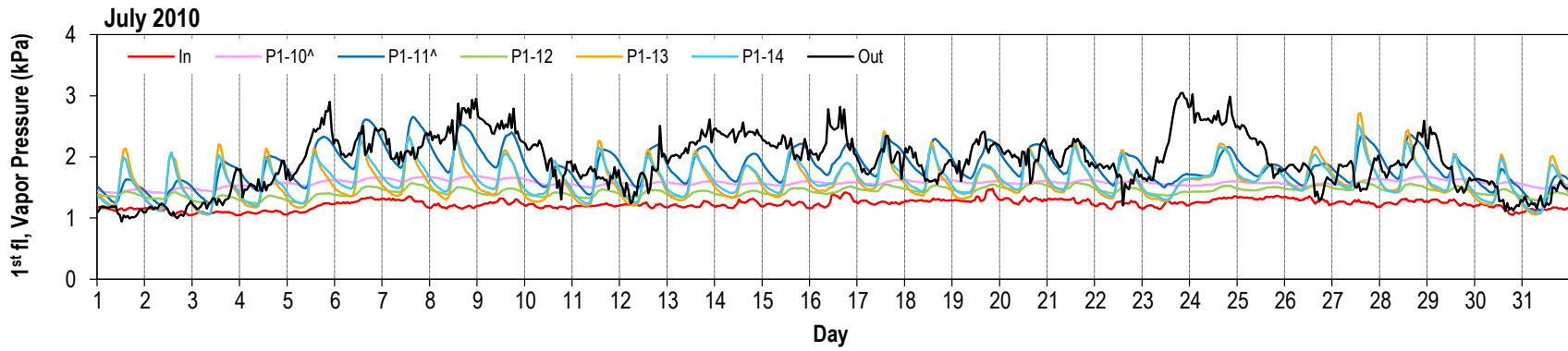
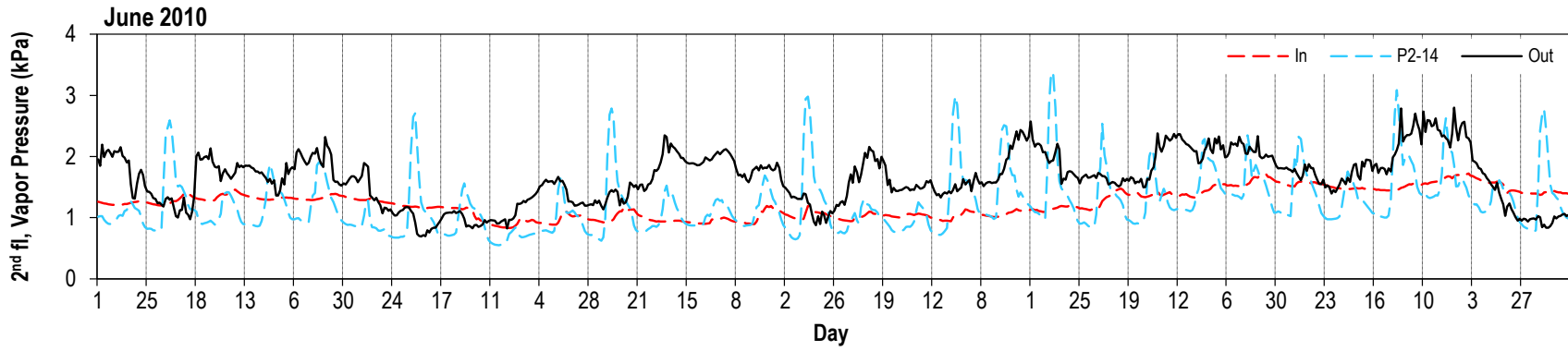
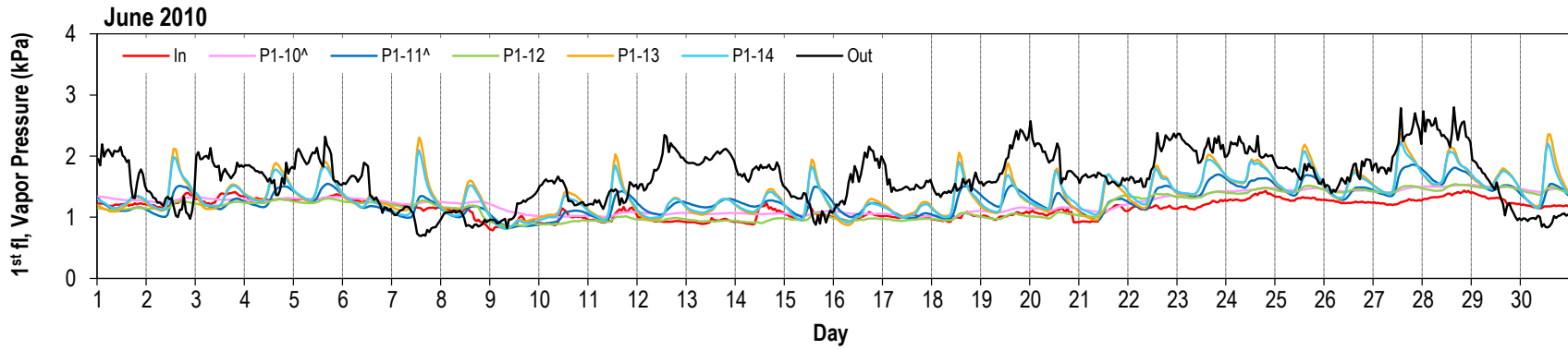

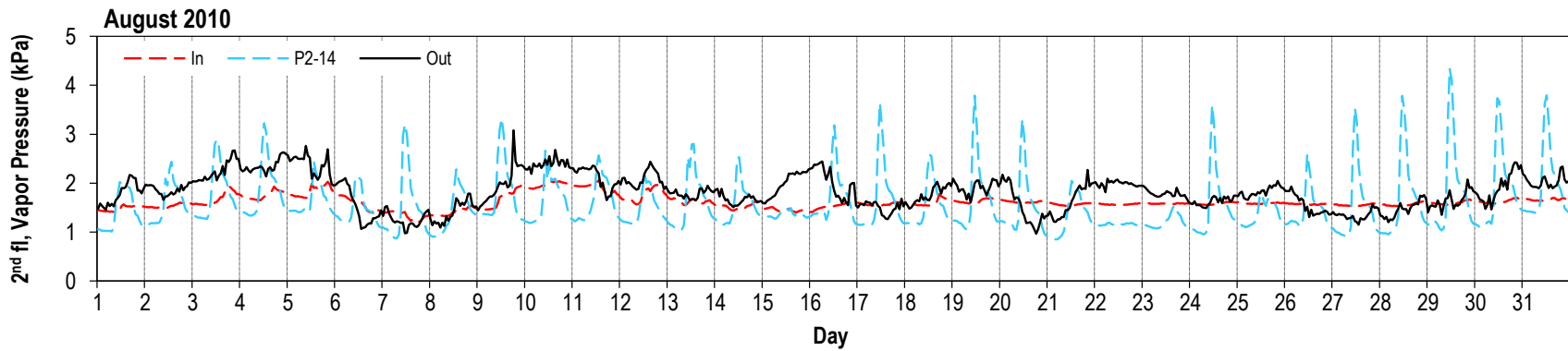
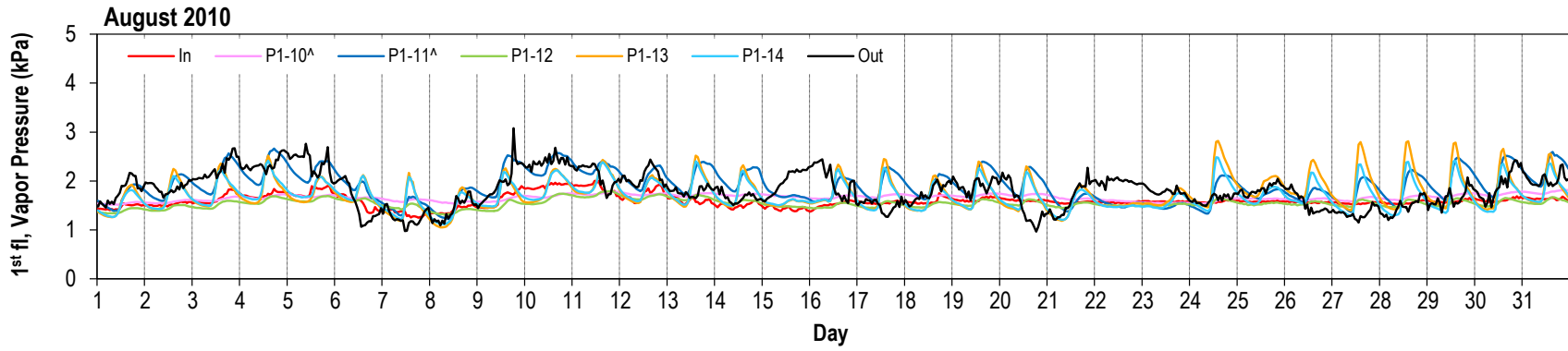
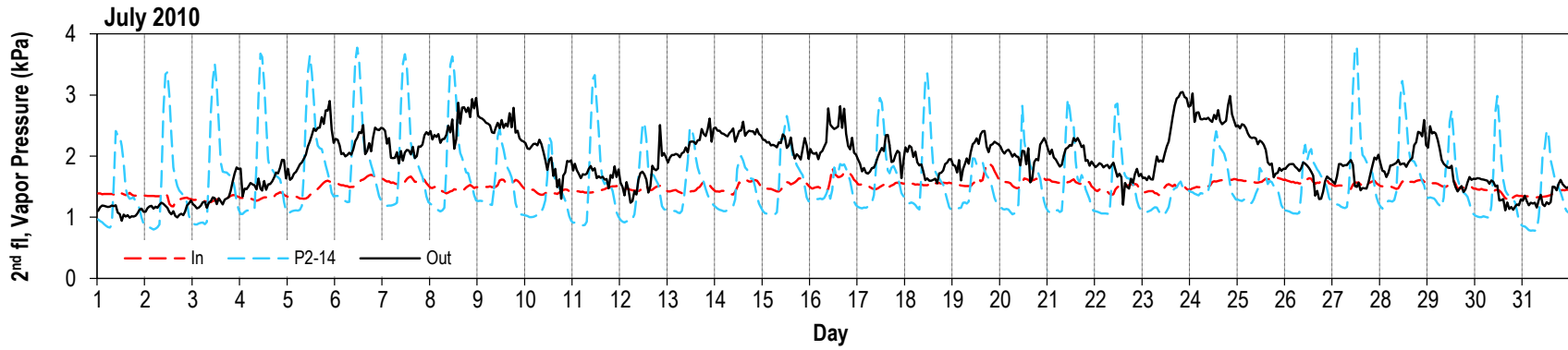

Heat flux (W/m^2) thru interior side of stud cavity. Refer to Figures 25 thru 28 for sensor location.

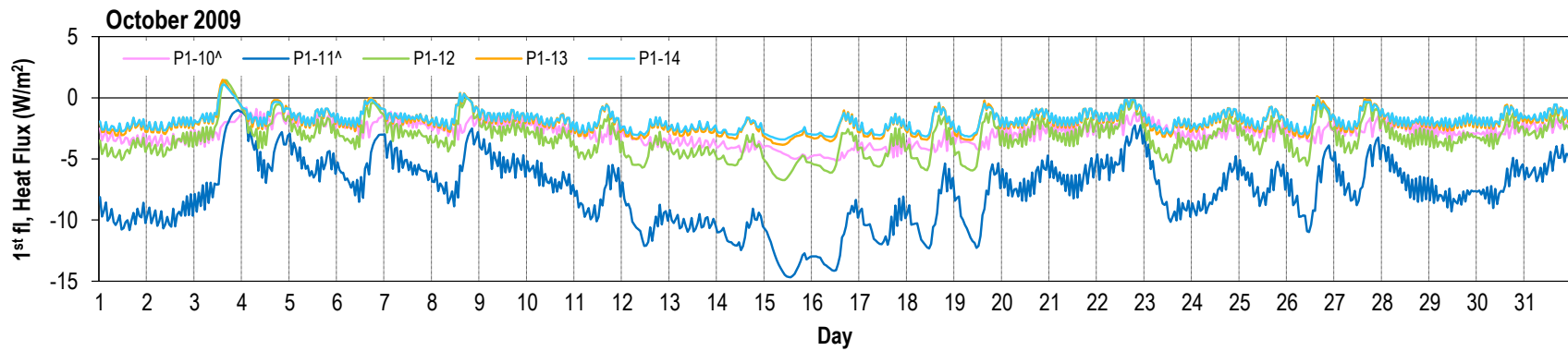
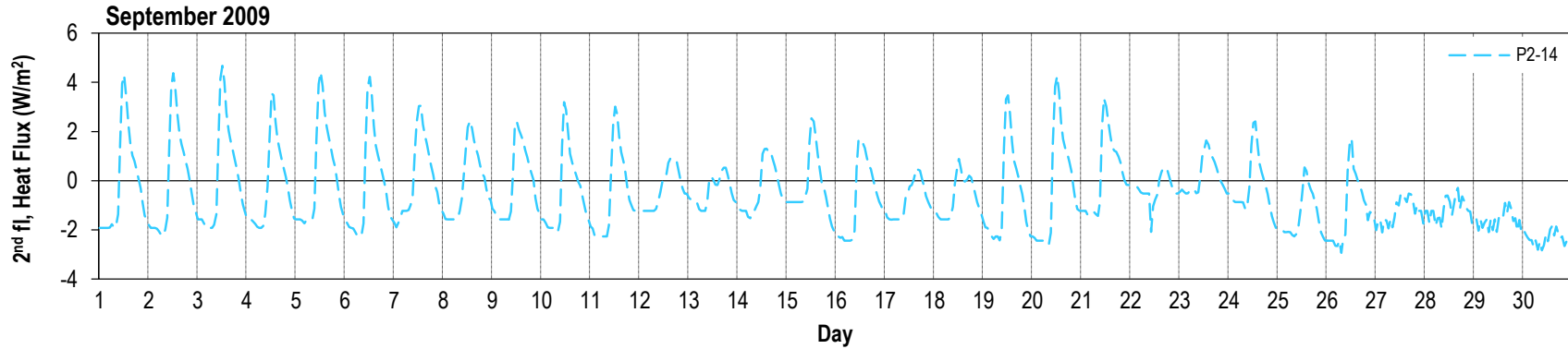
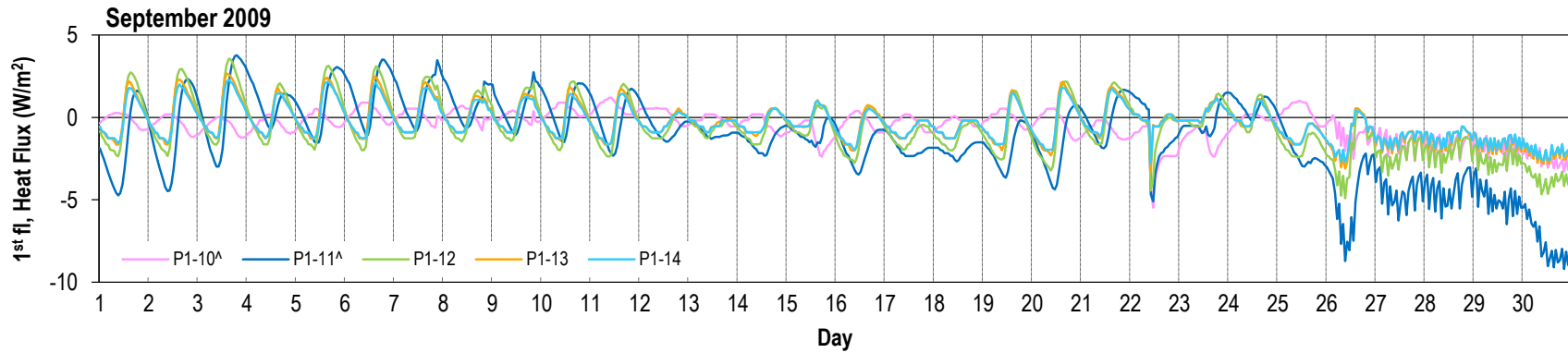

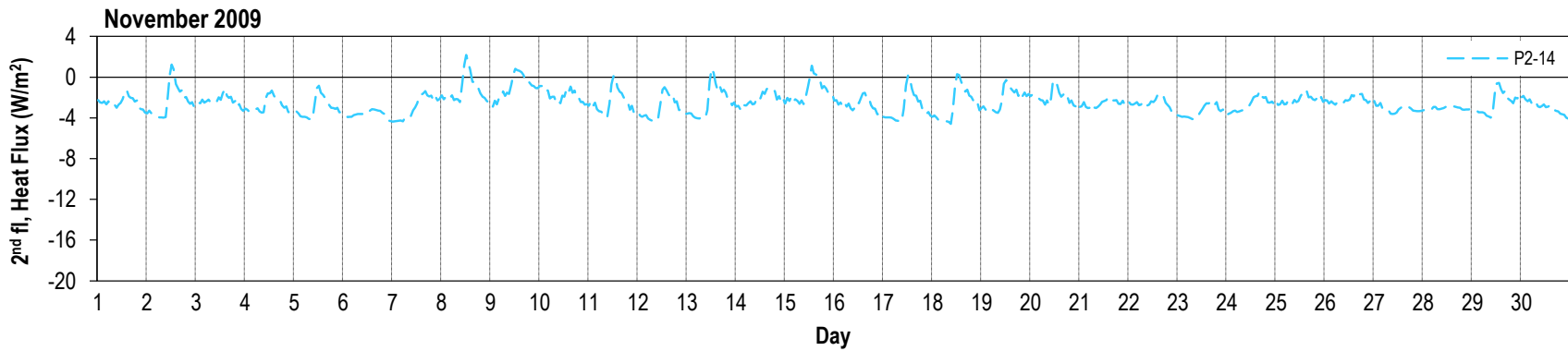
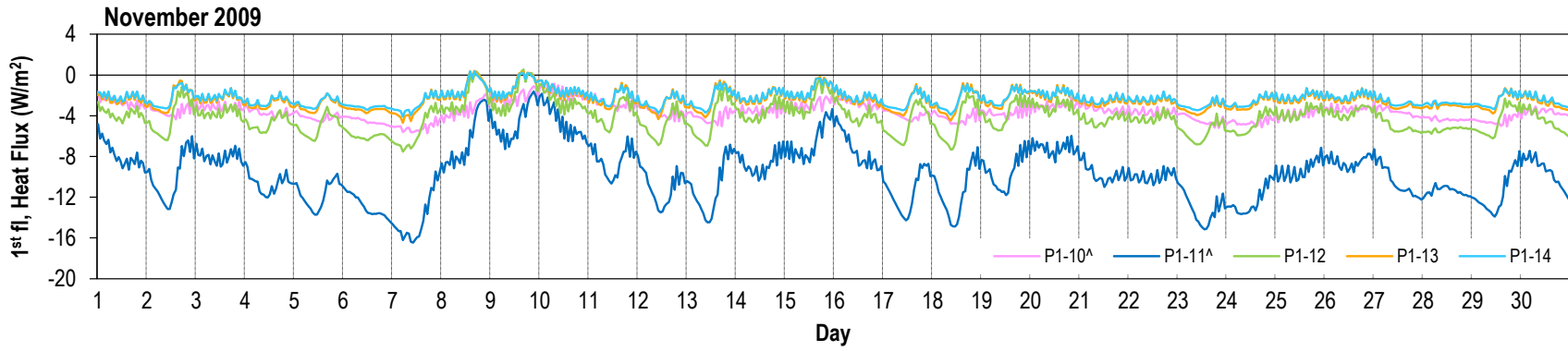
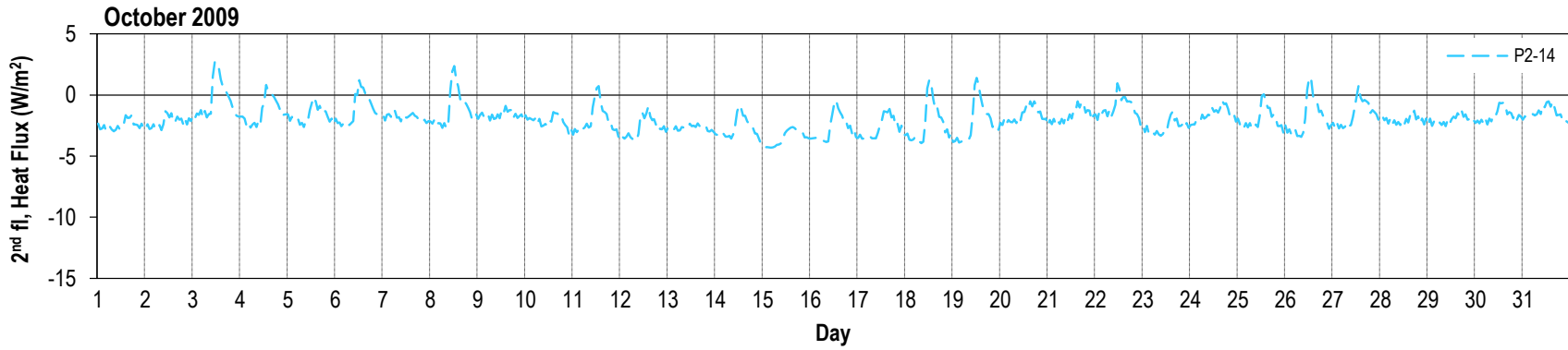

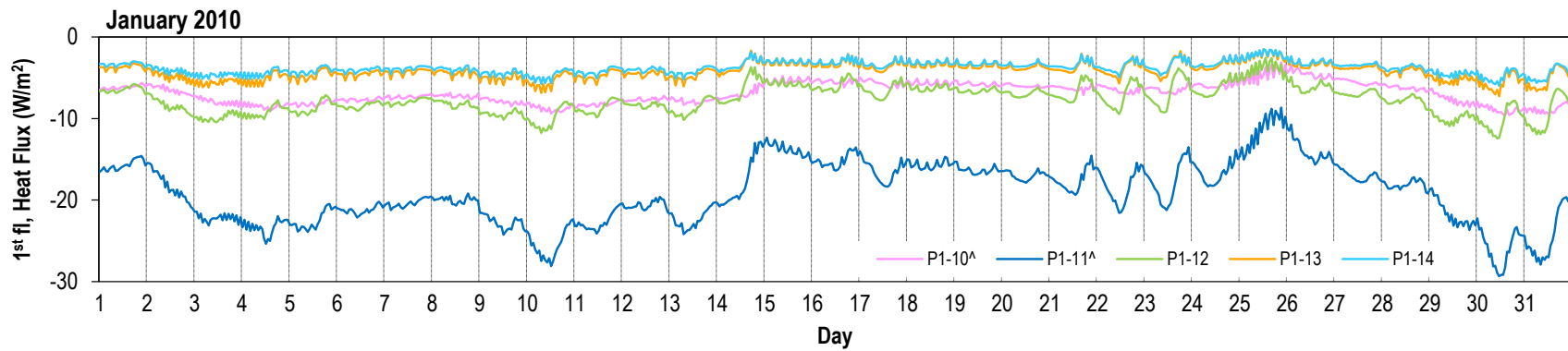
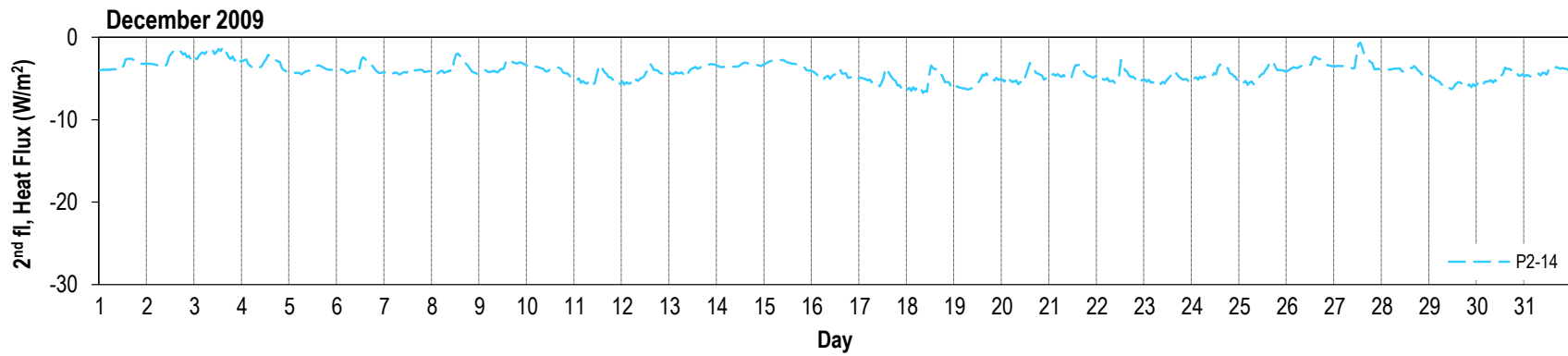
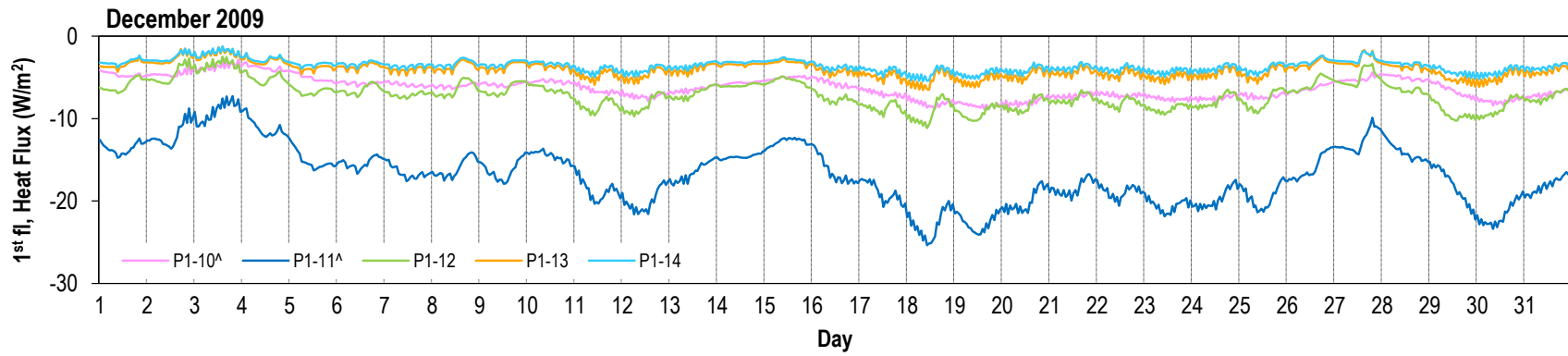

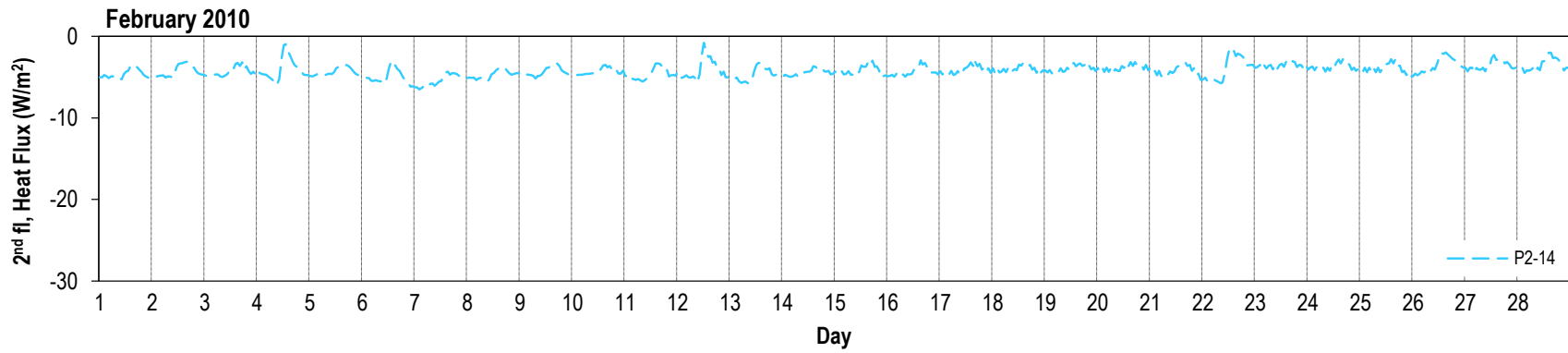
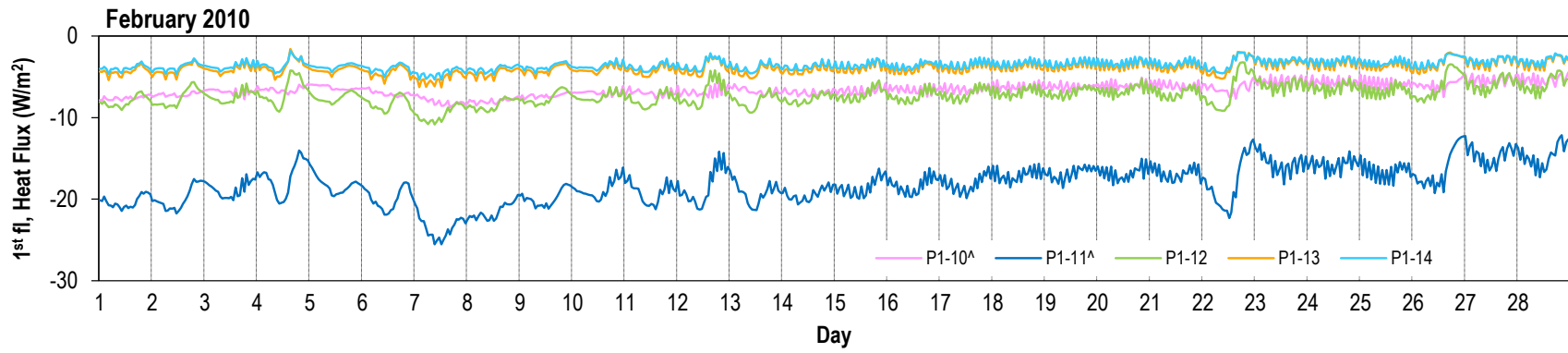
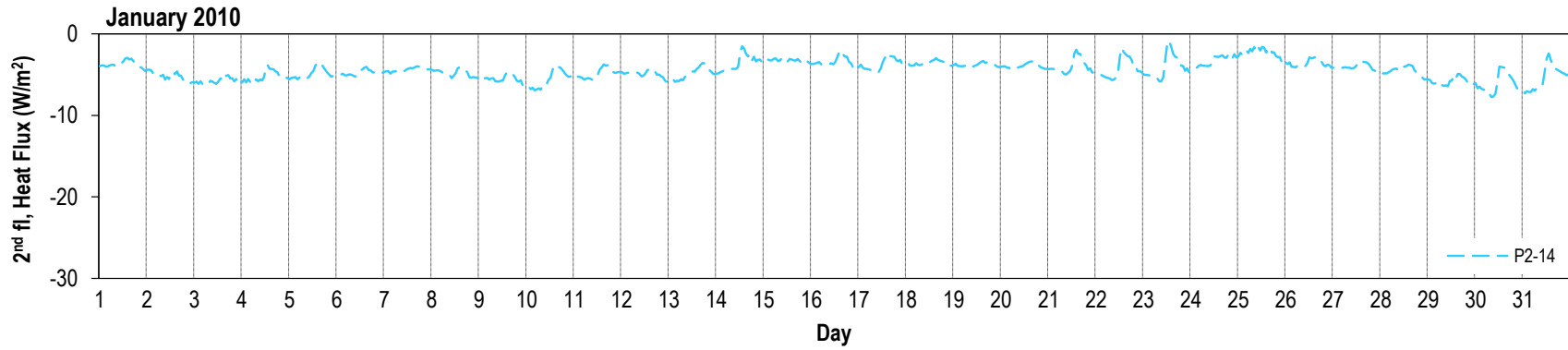

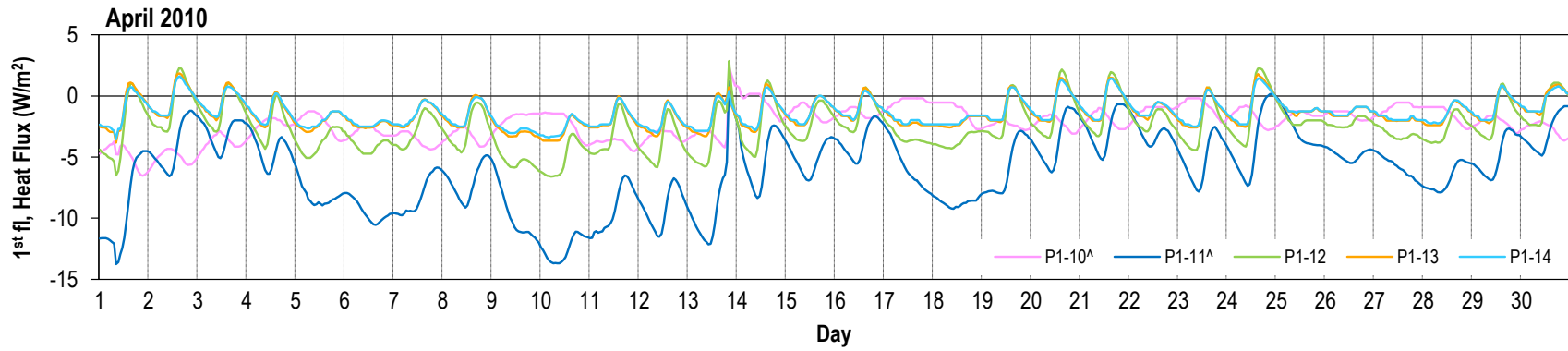
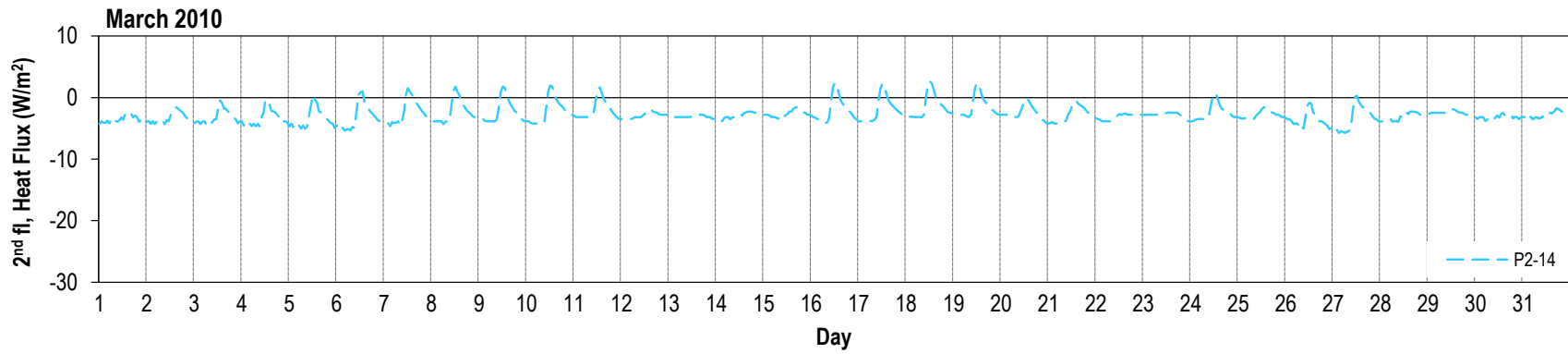
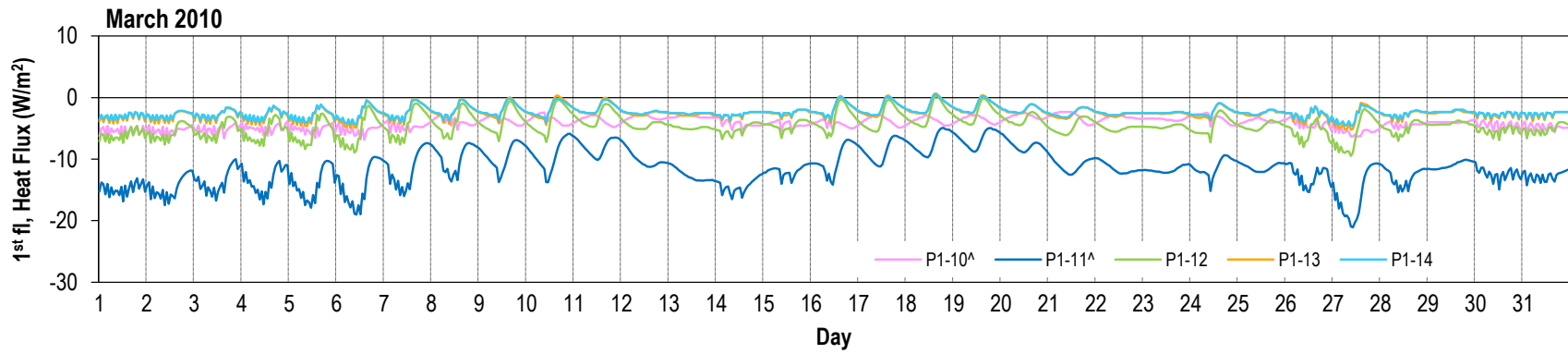

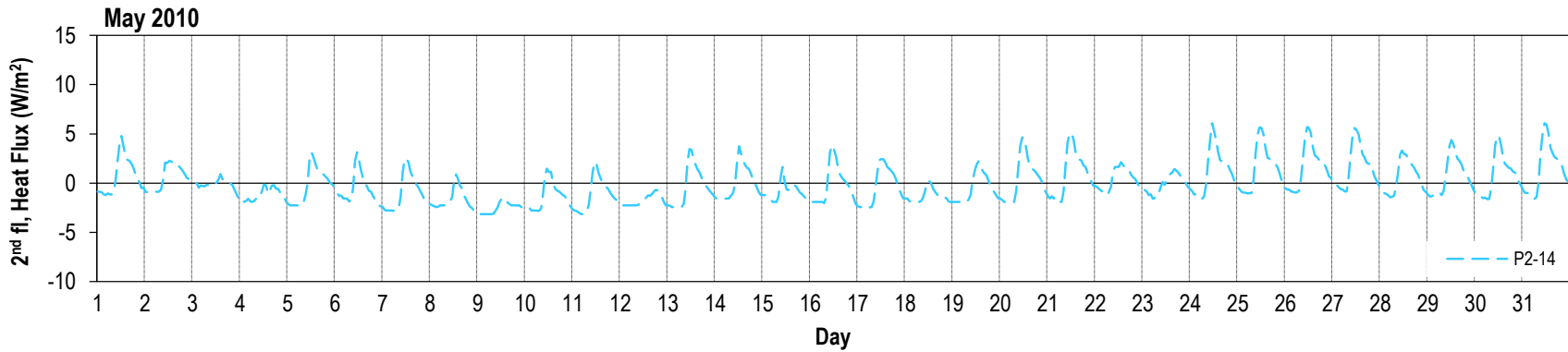
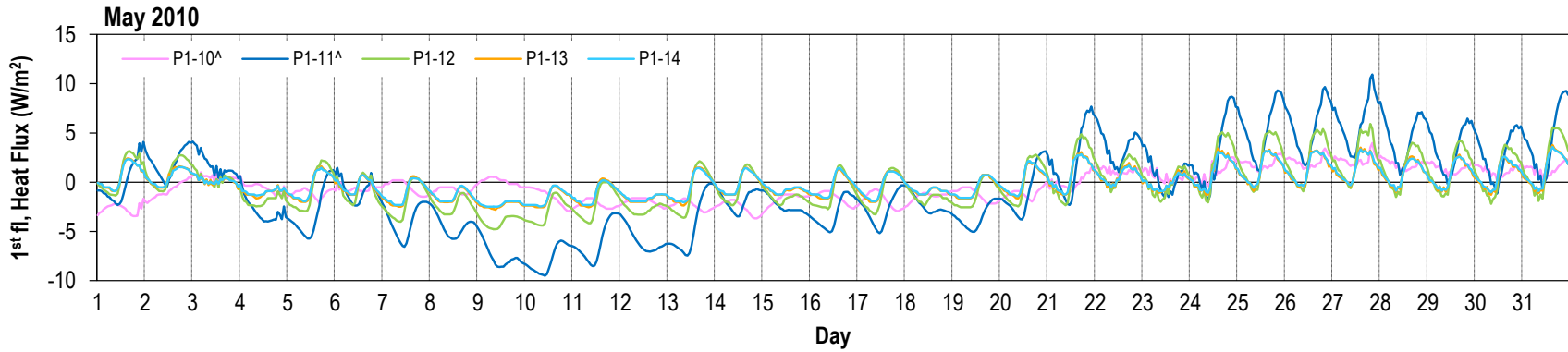
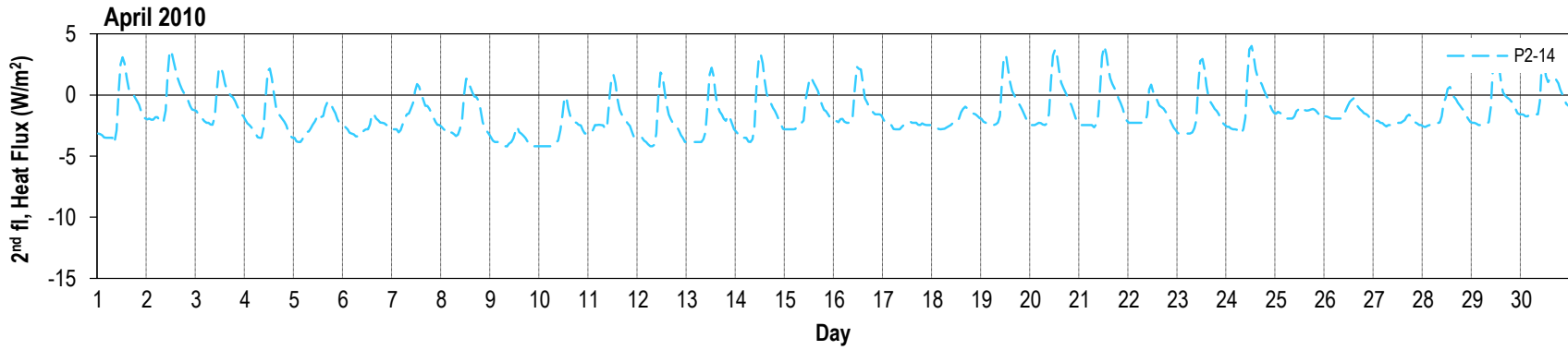

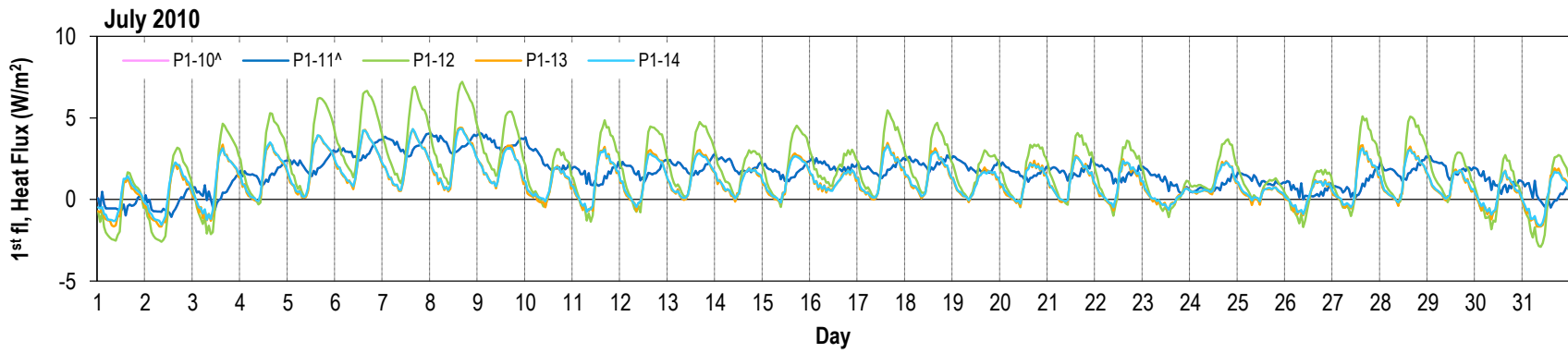
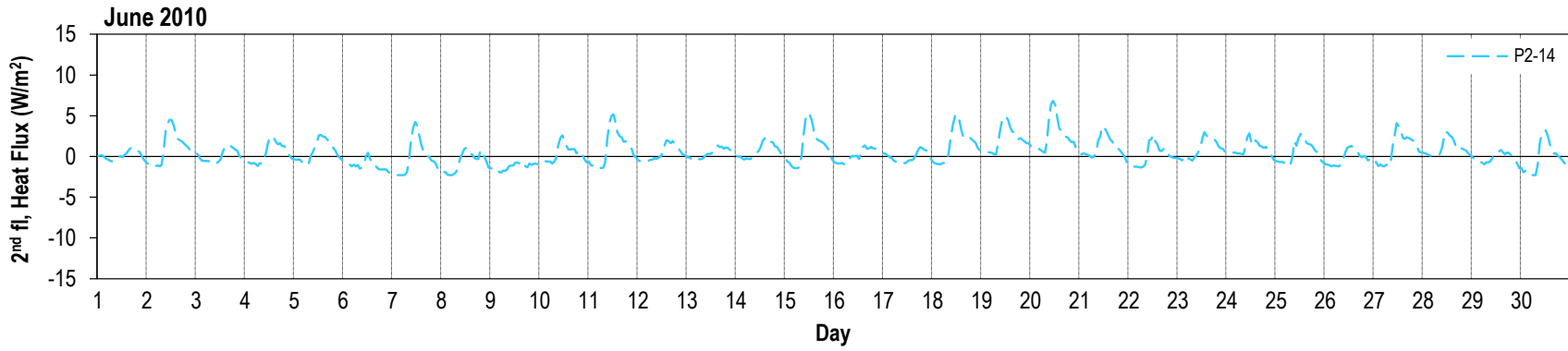
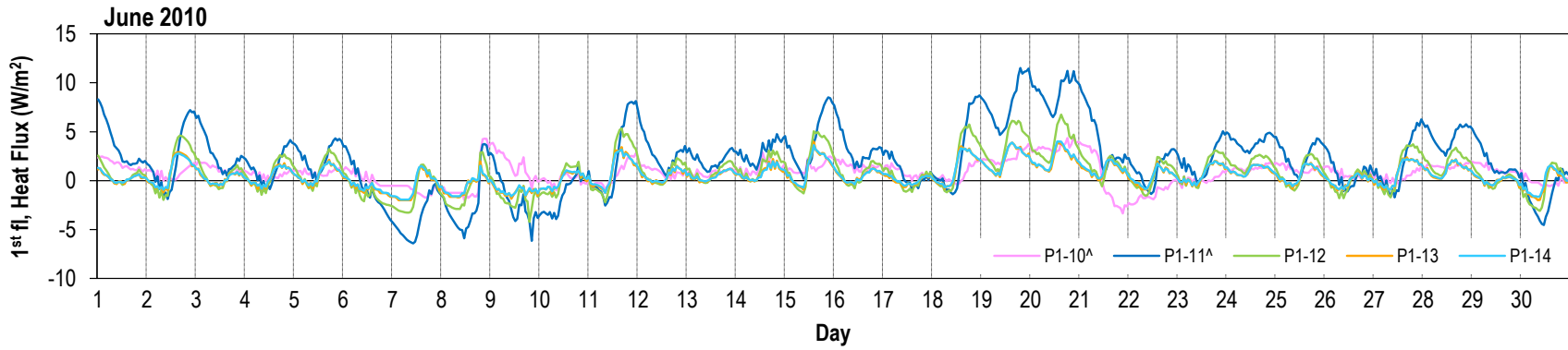

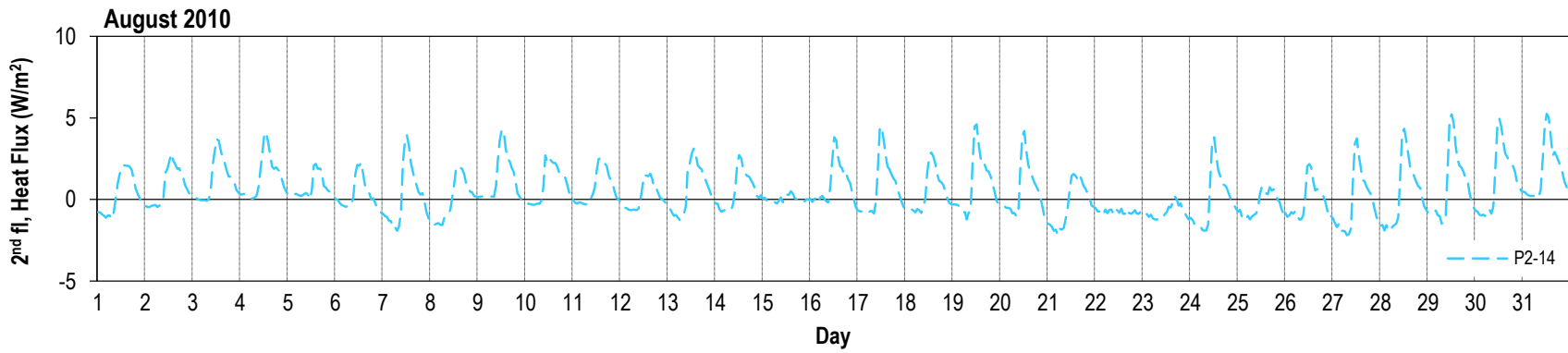
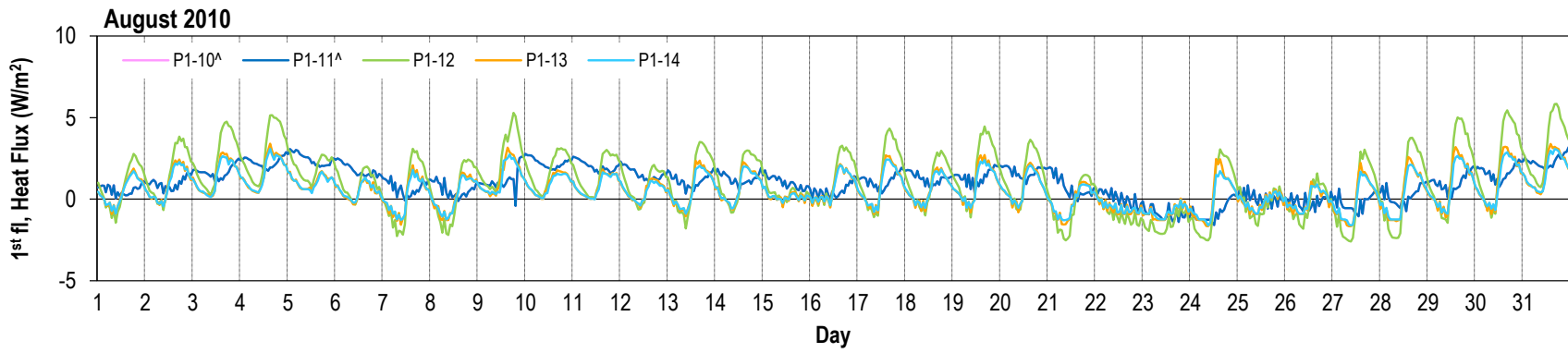
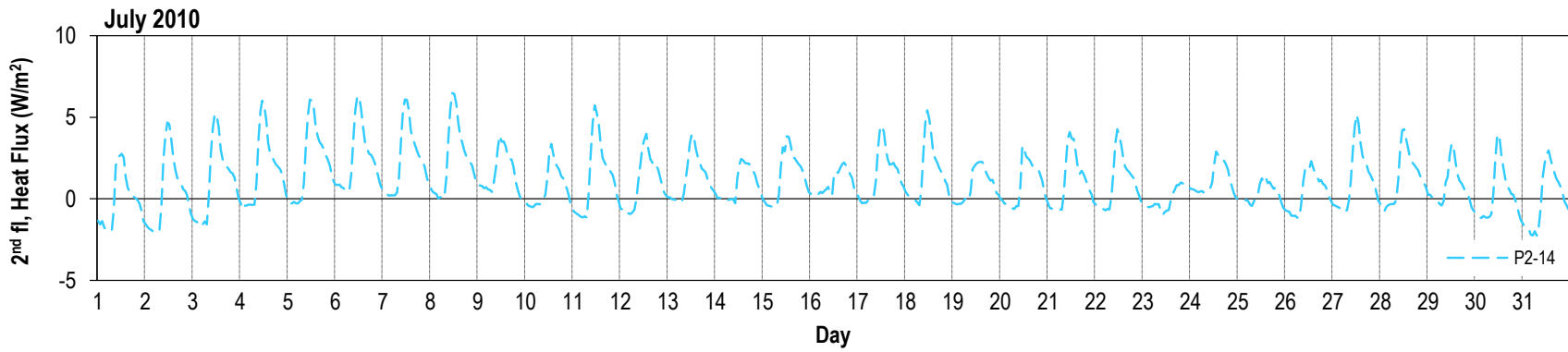

Cooling loads (Wh/m²). Refer to Figures 25 thru 28 for sensor location.

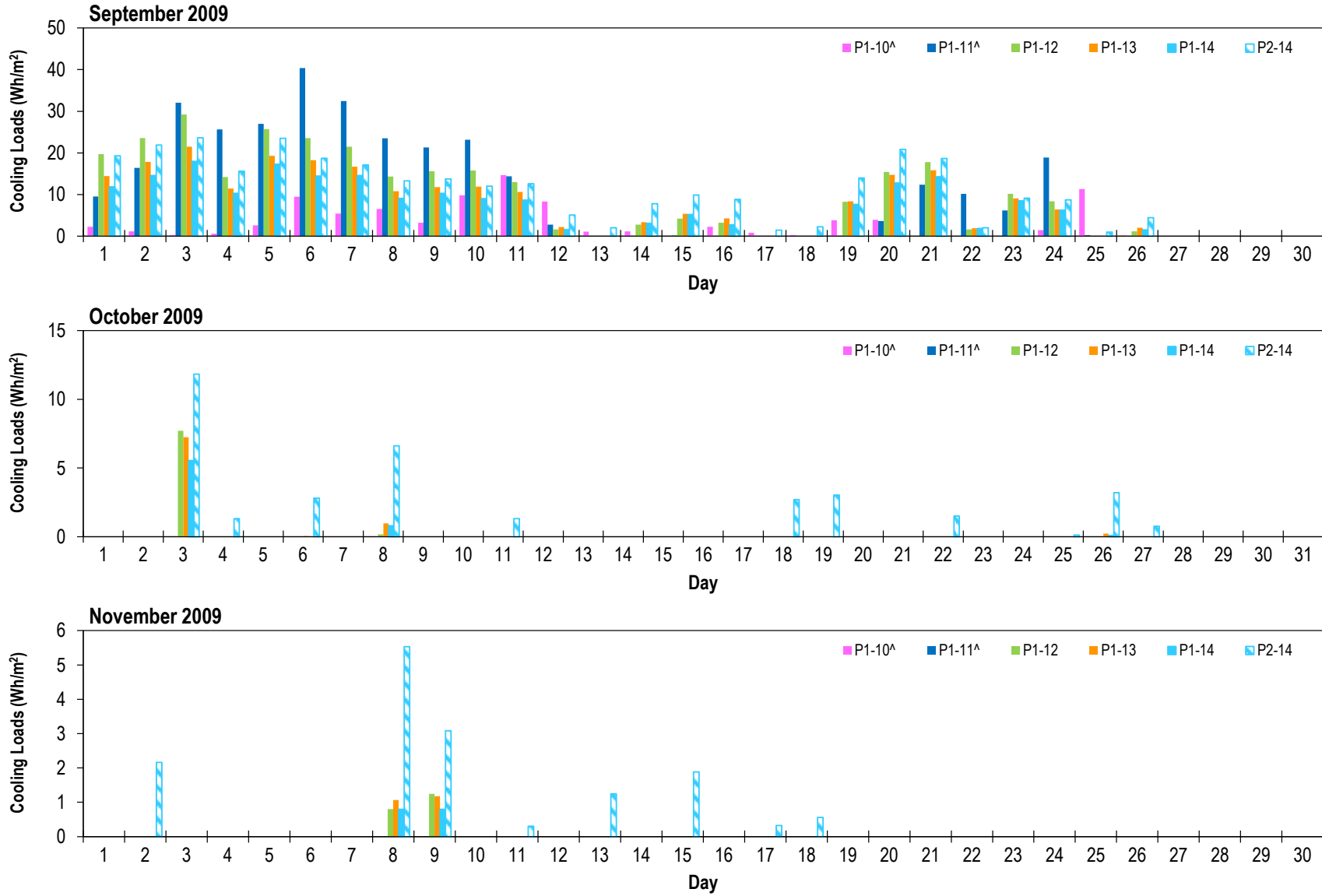

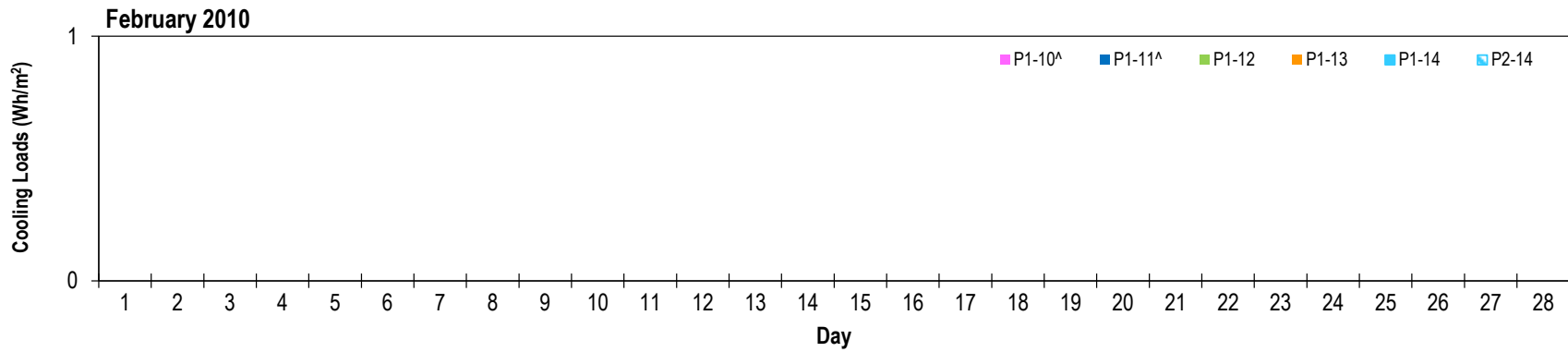
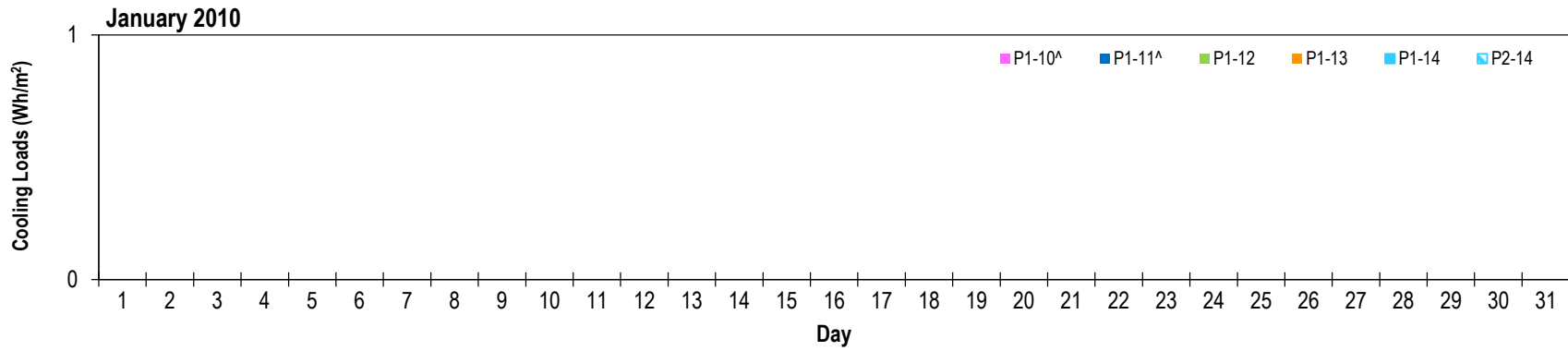
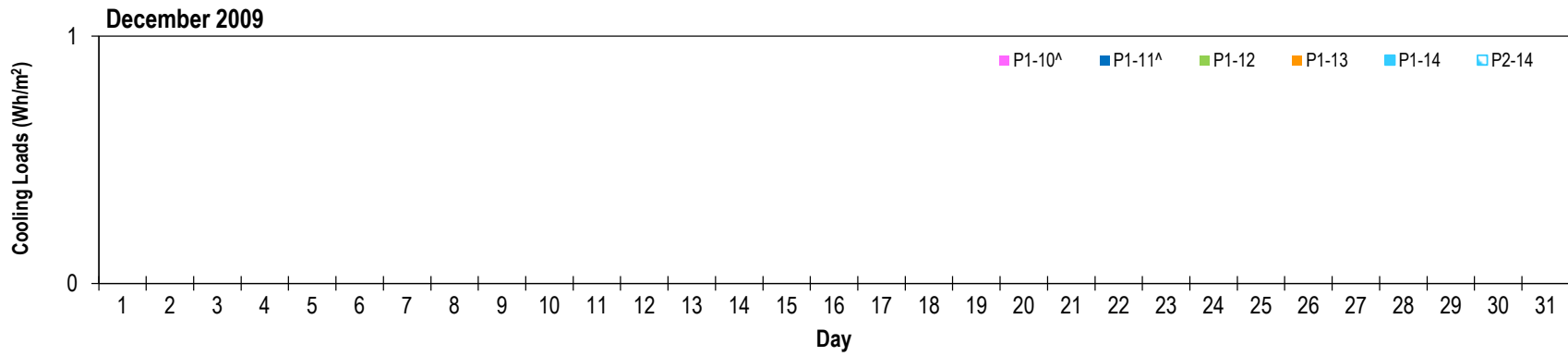

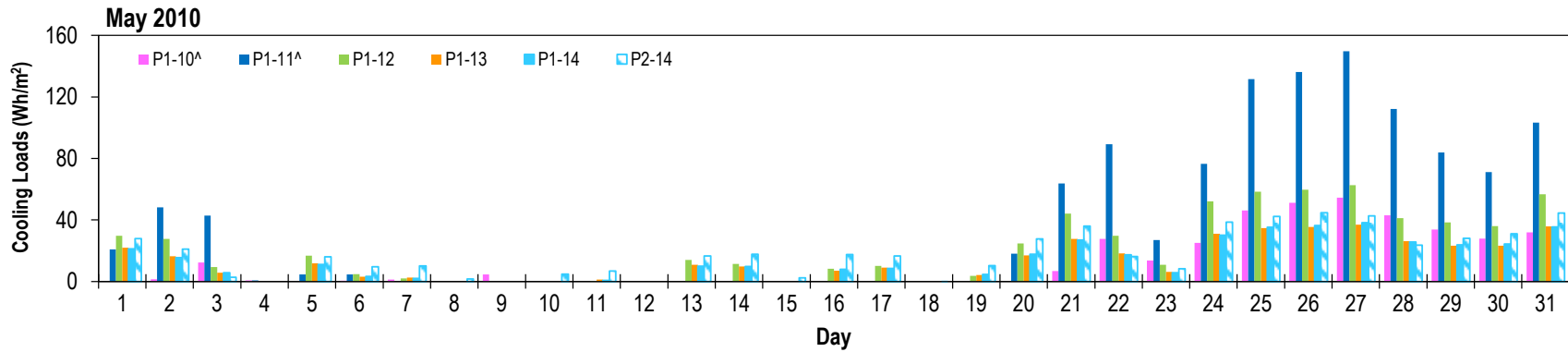
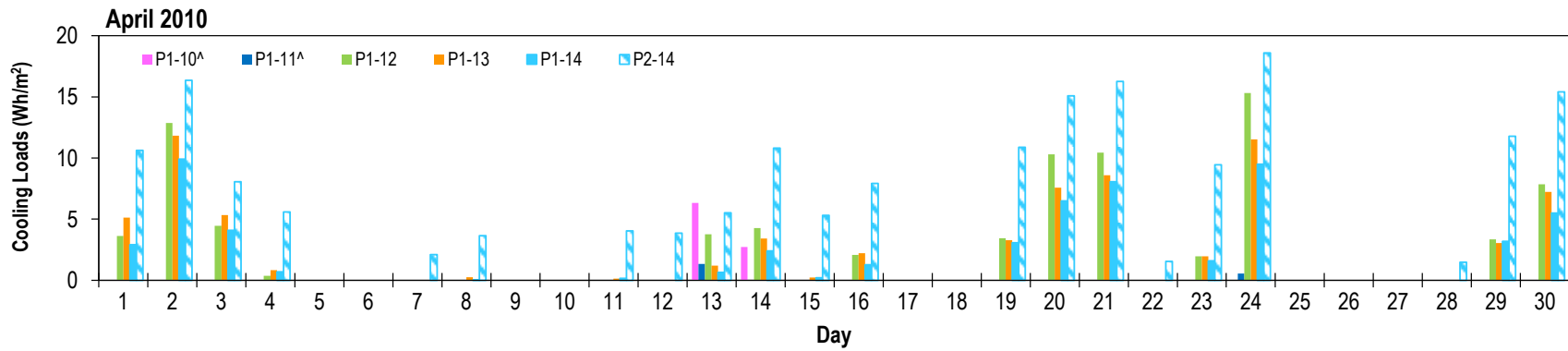
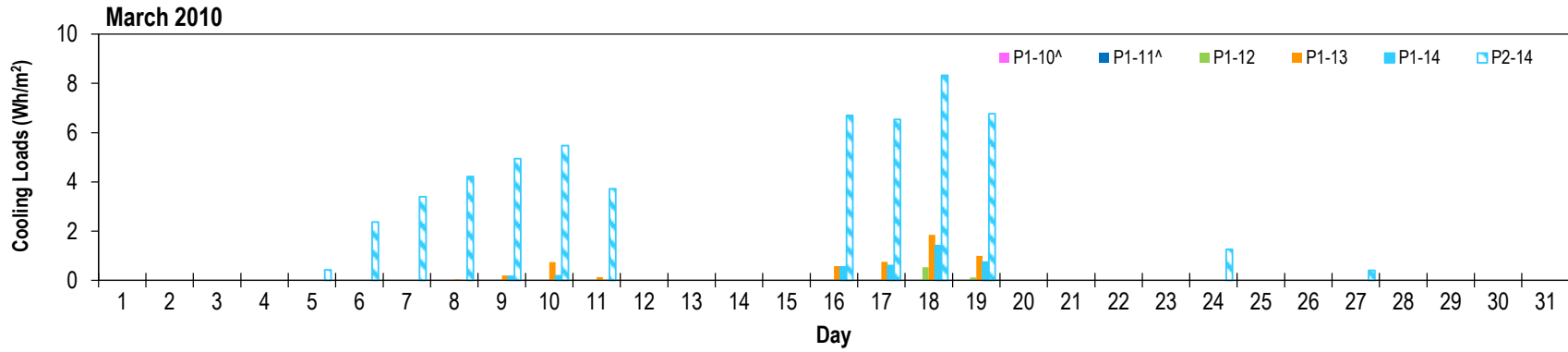

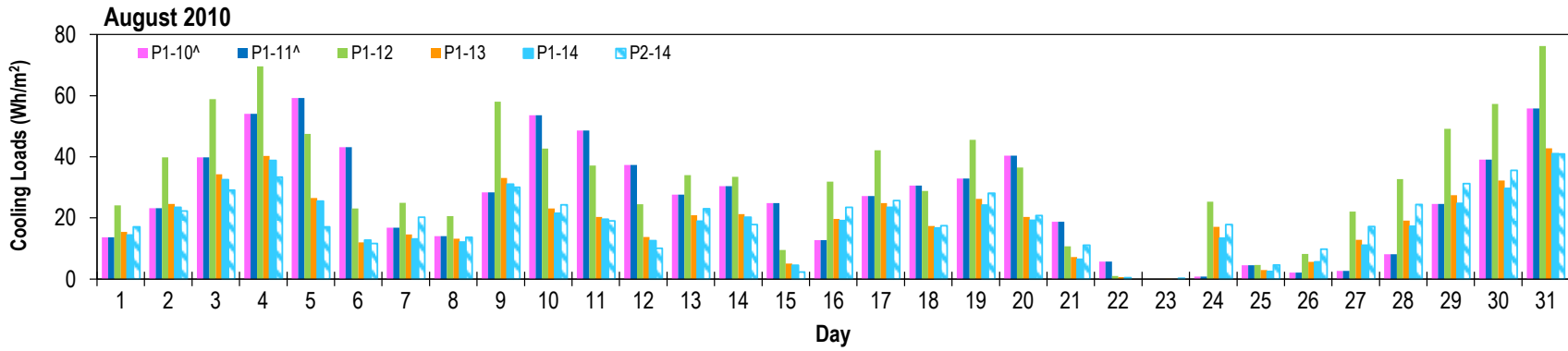
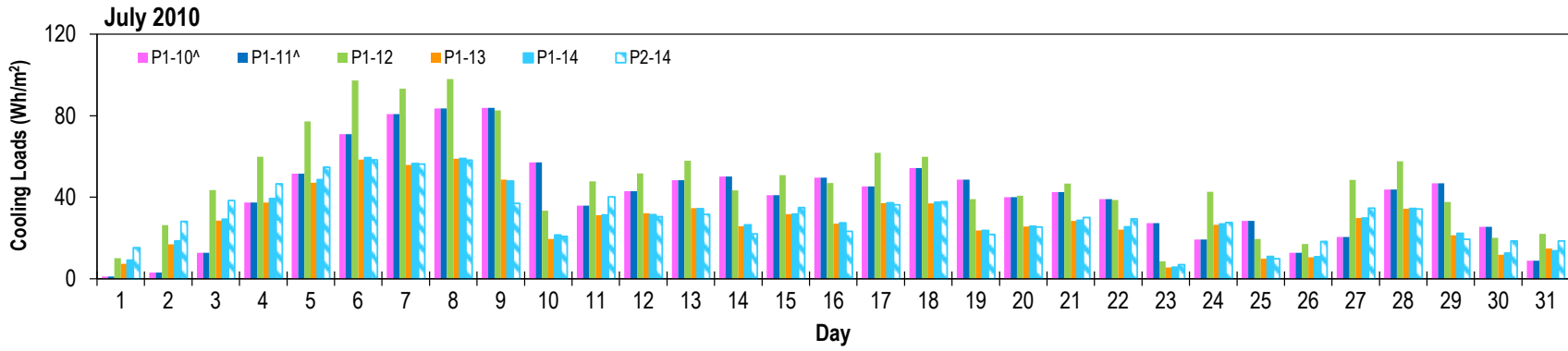
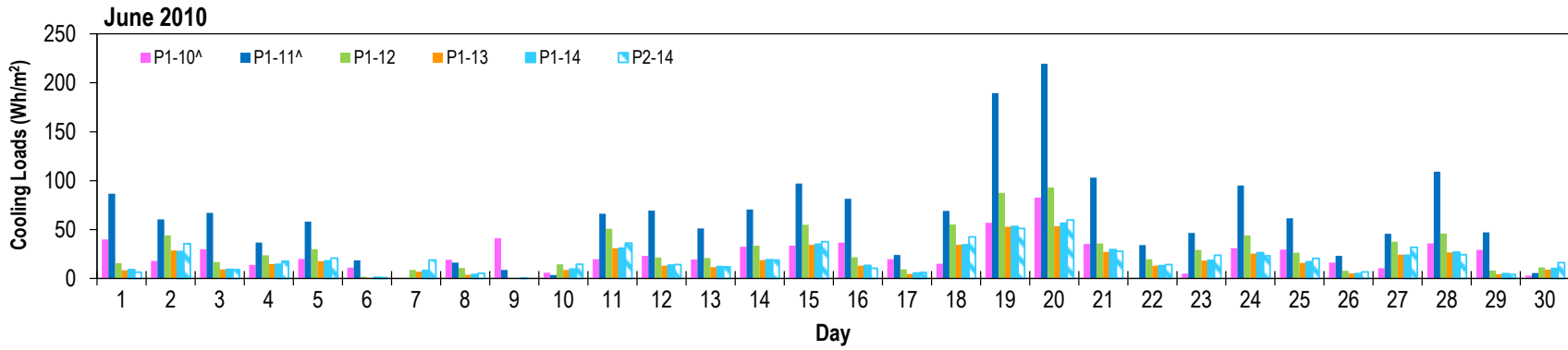

Heating loads (Wh/m²). Refer to Figures 25 thru 28 for sensor location.

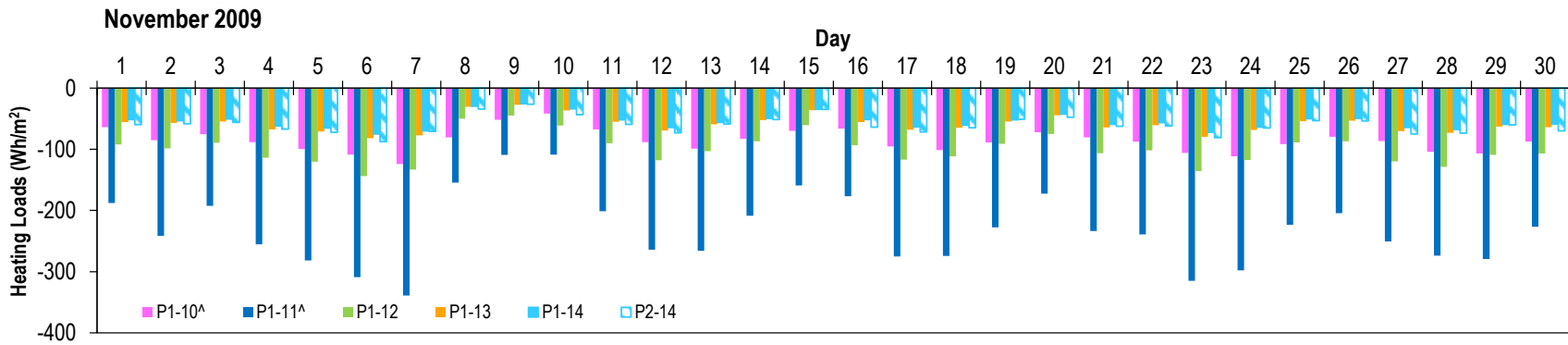
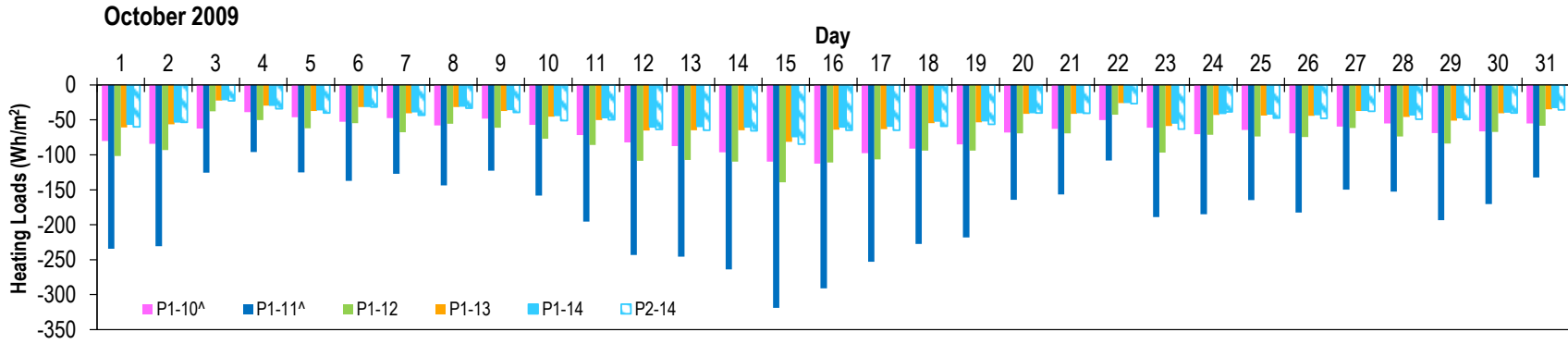
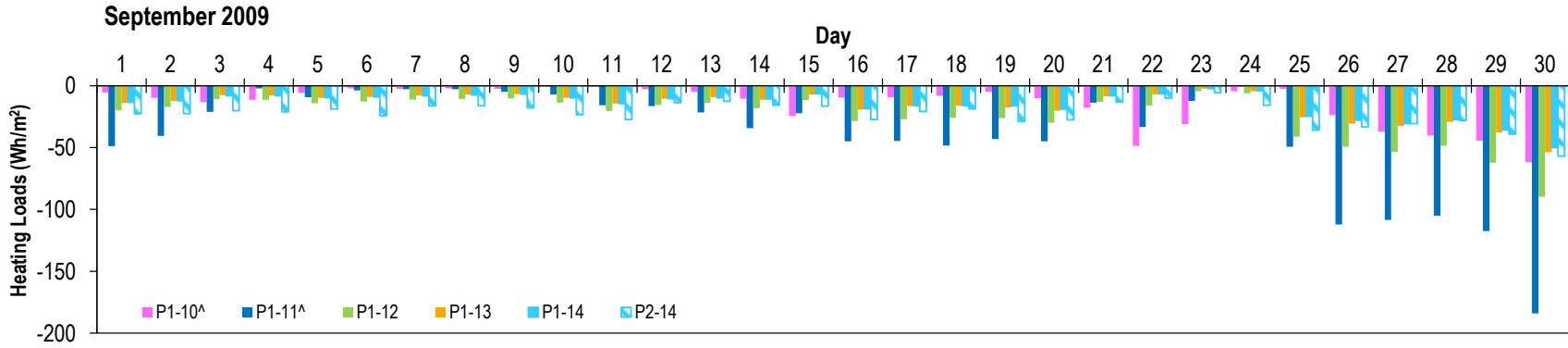

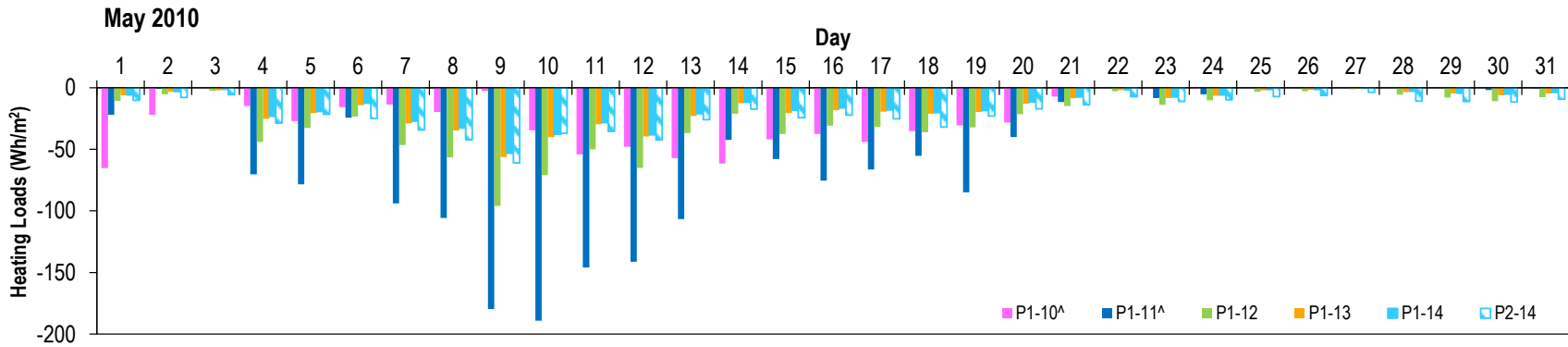
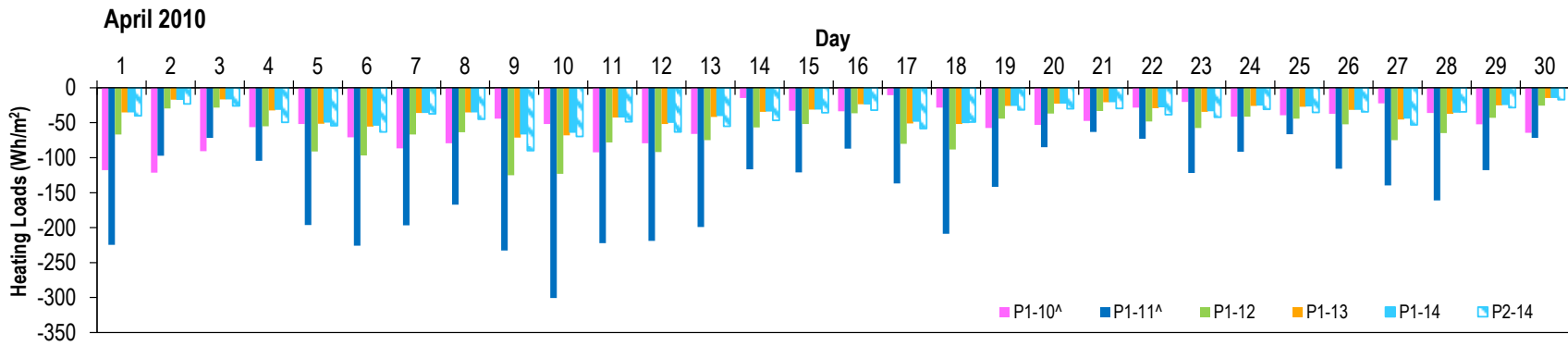
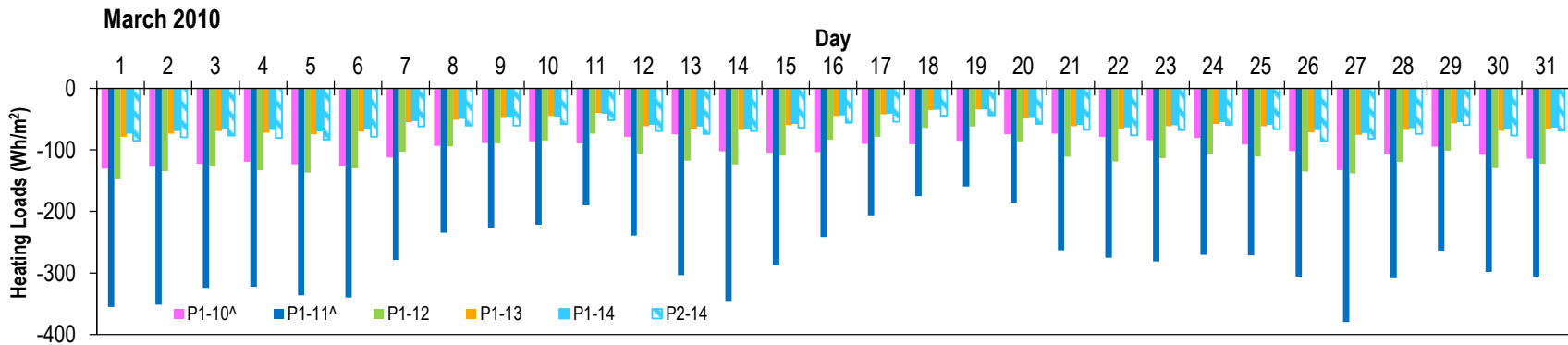

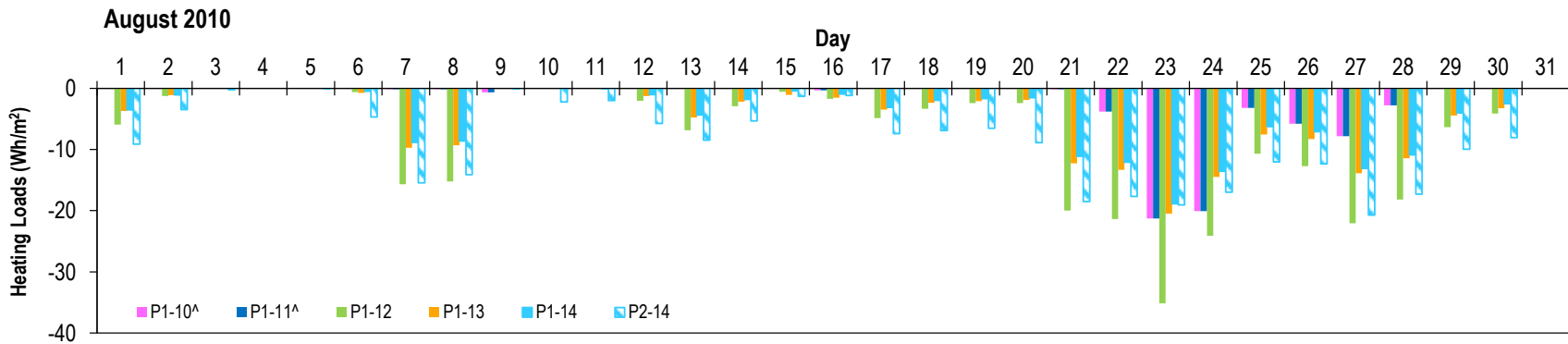
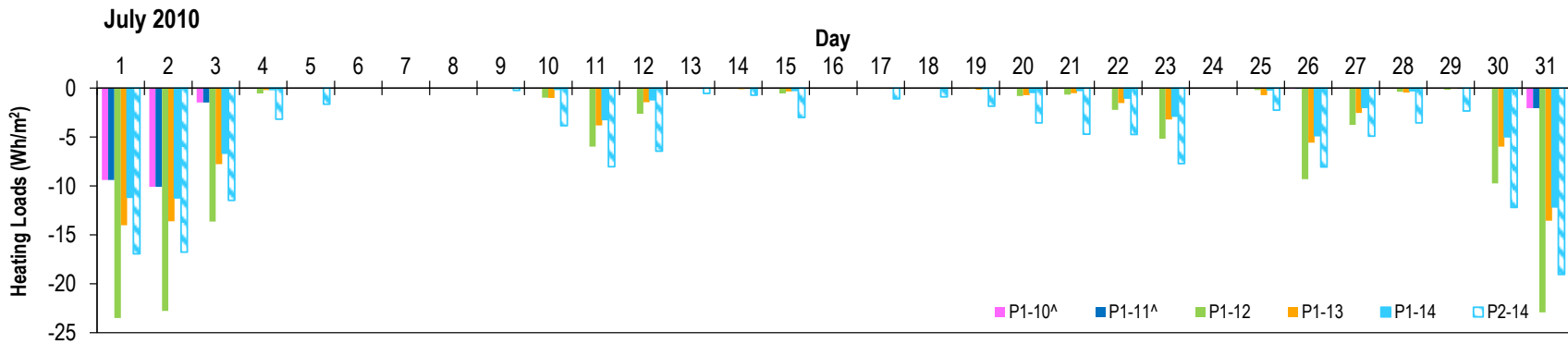
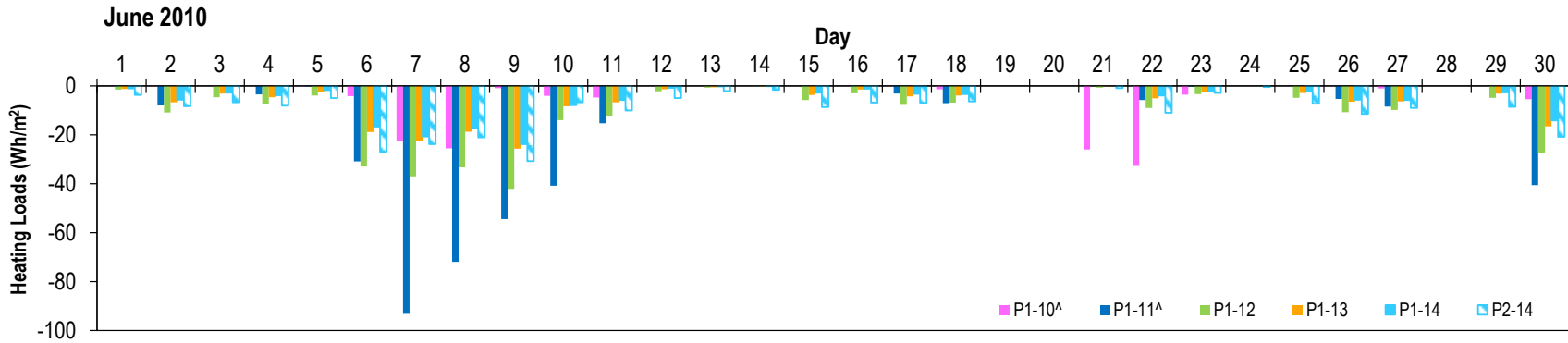

Appendix C: South Panels

Temperature (°C) at exterior side of stud cavity. Refer to Figures 25 thru 28 for sensor location.

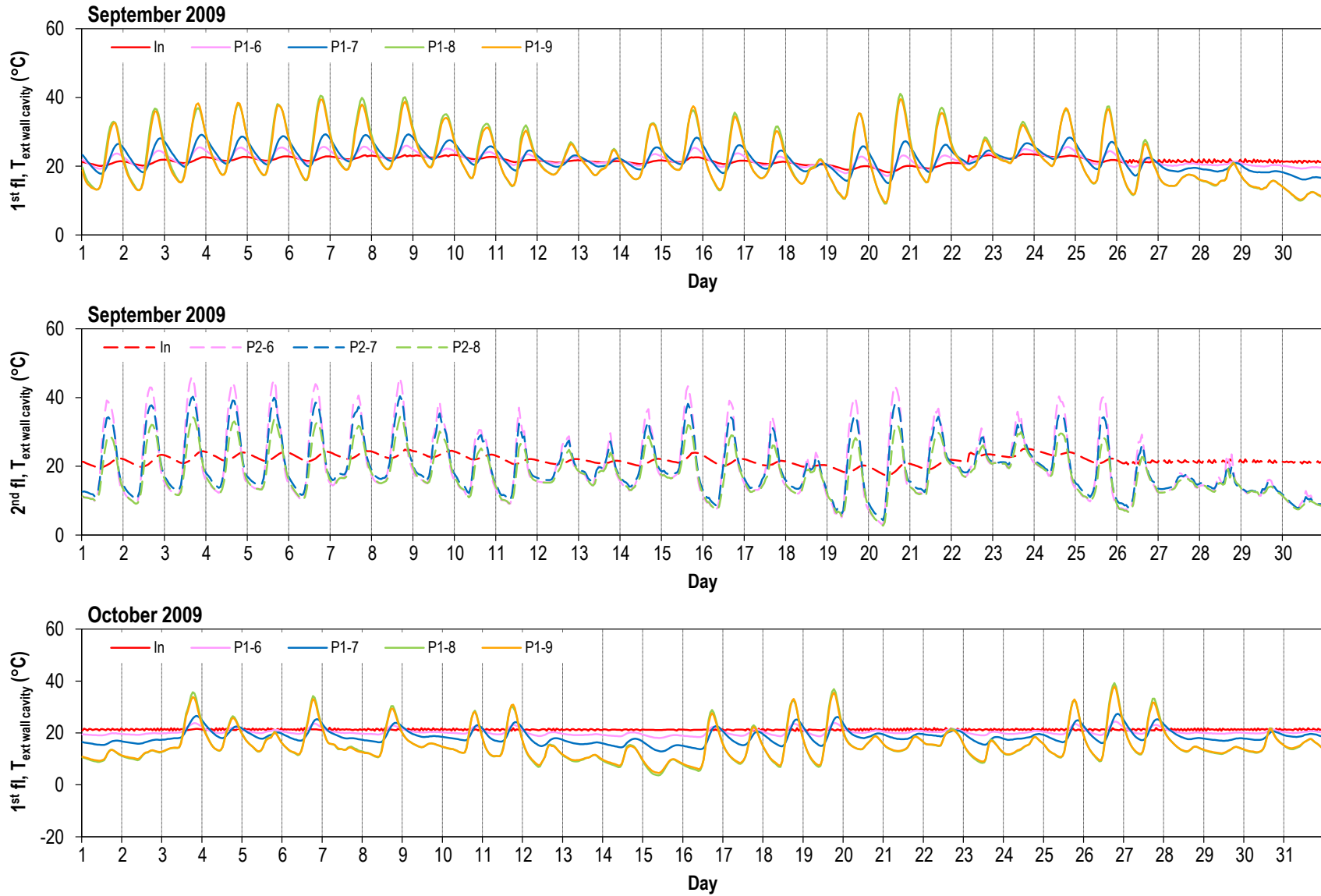

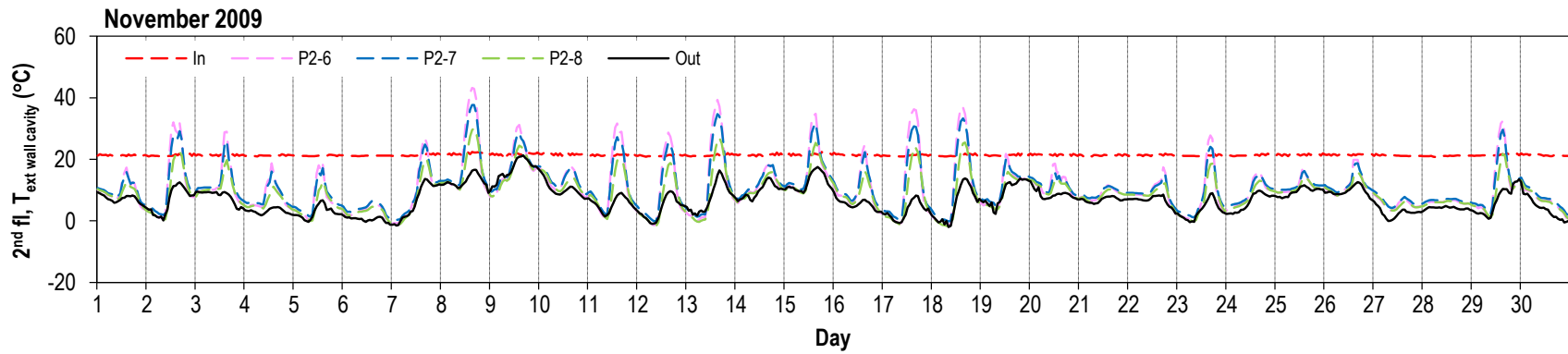
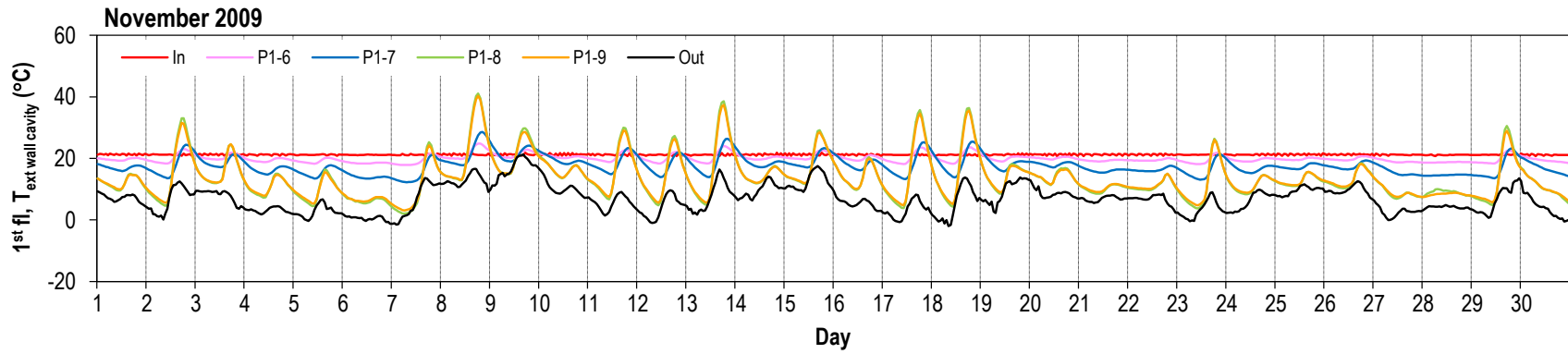
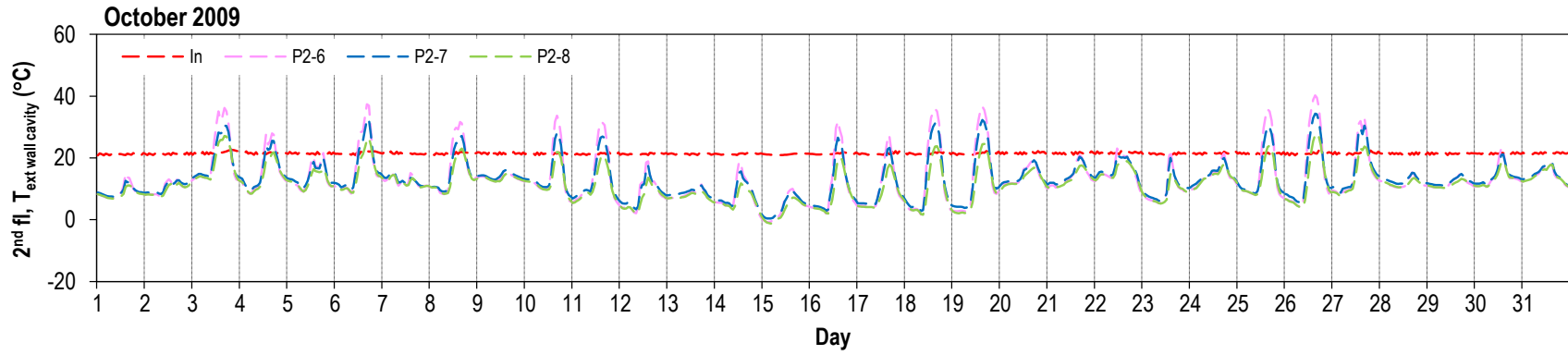

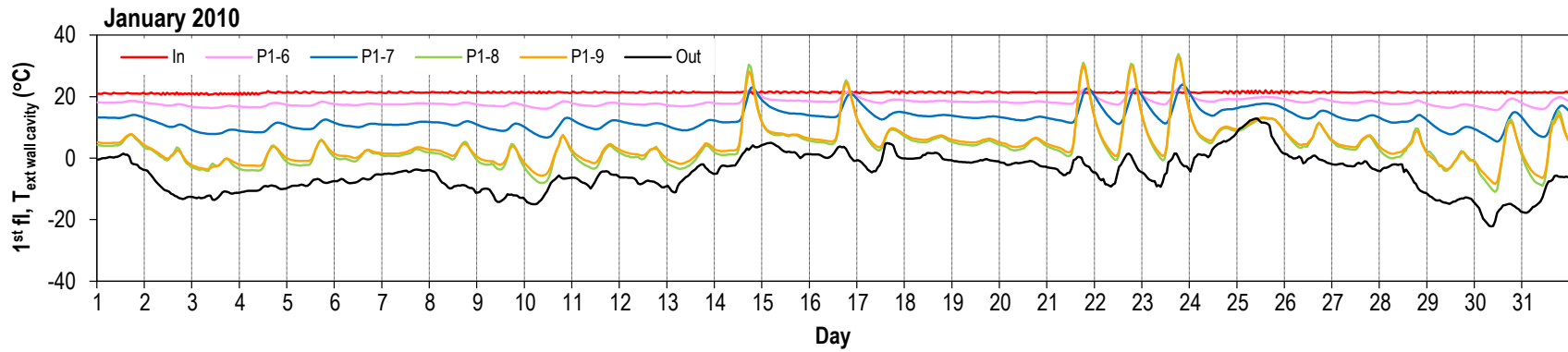
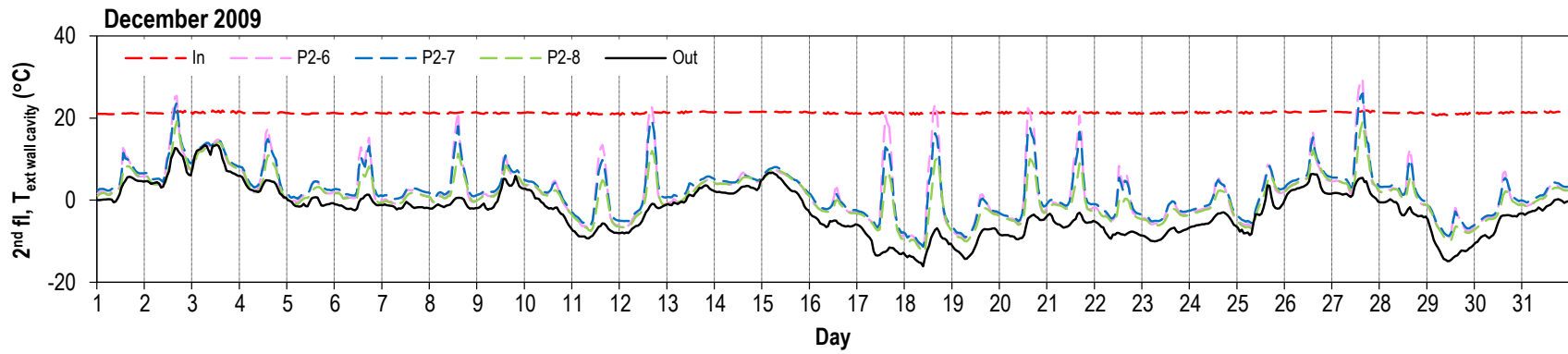
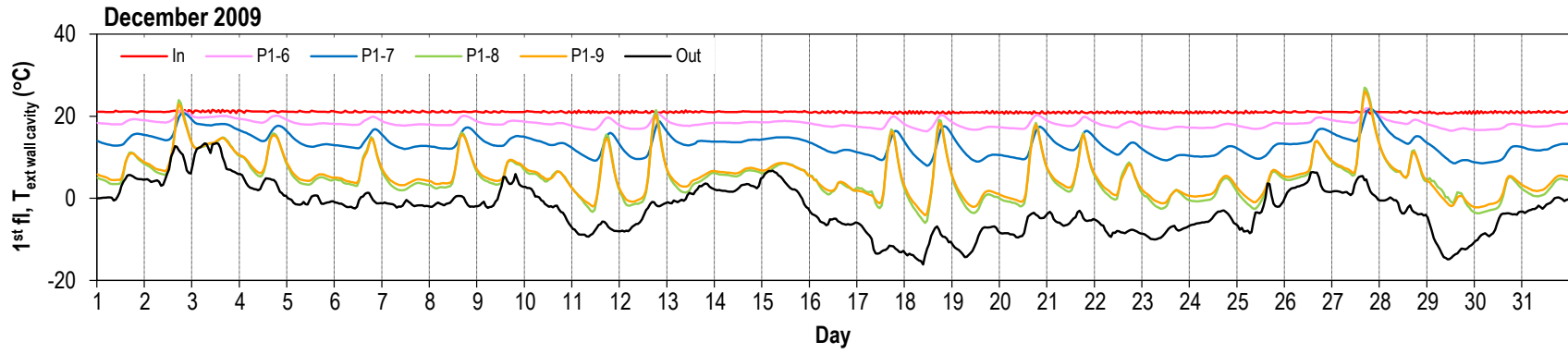

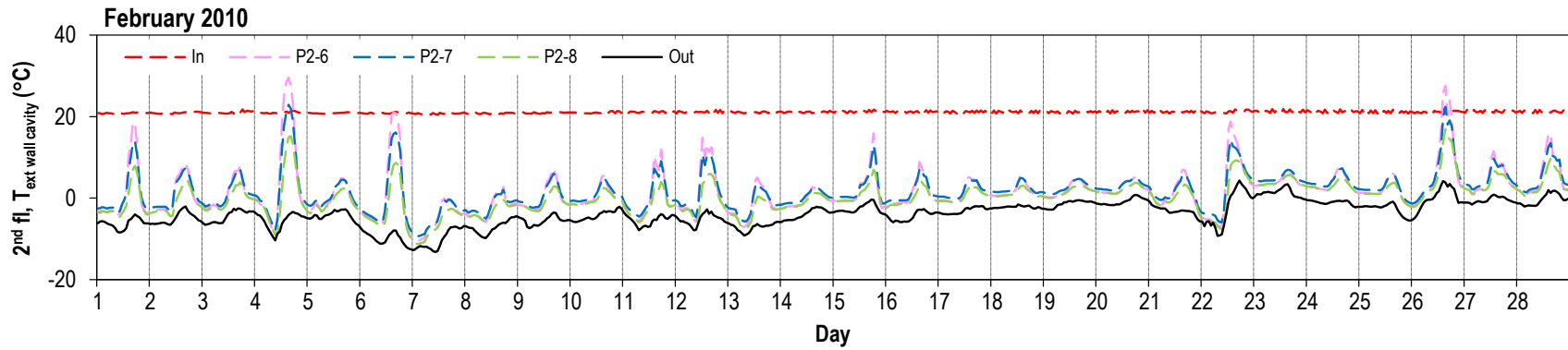
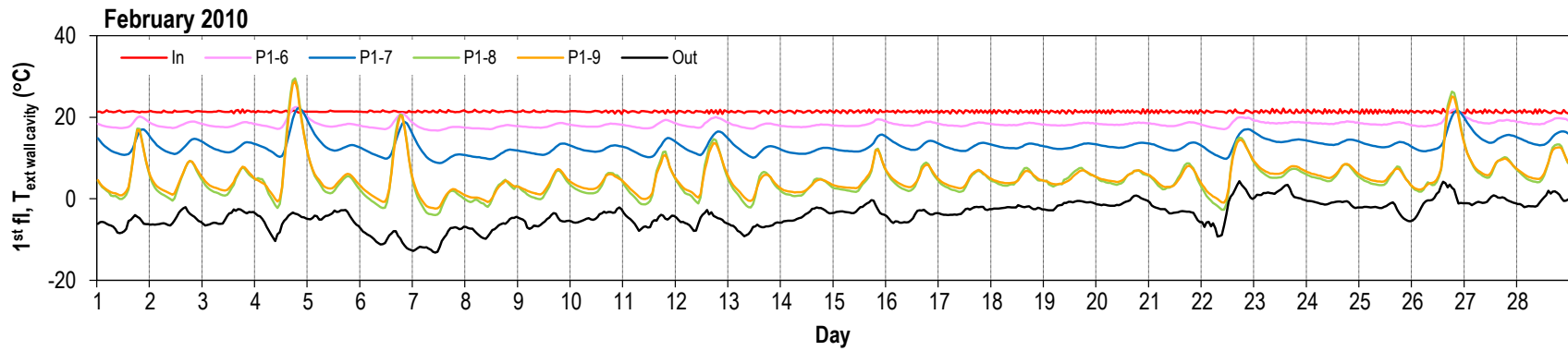
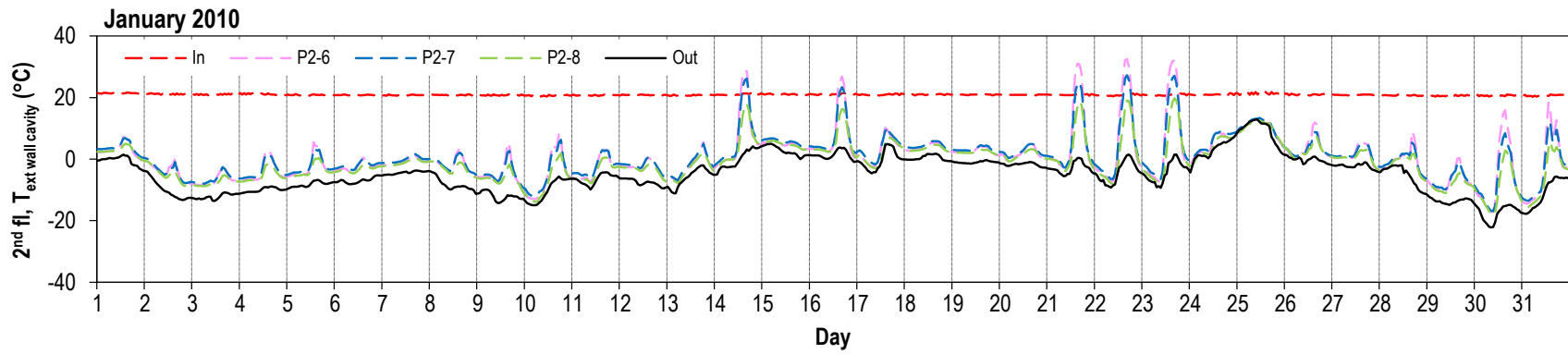

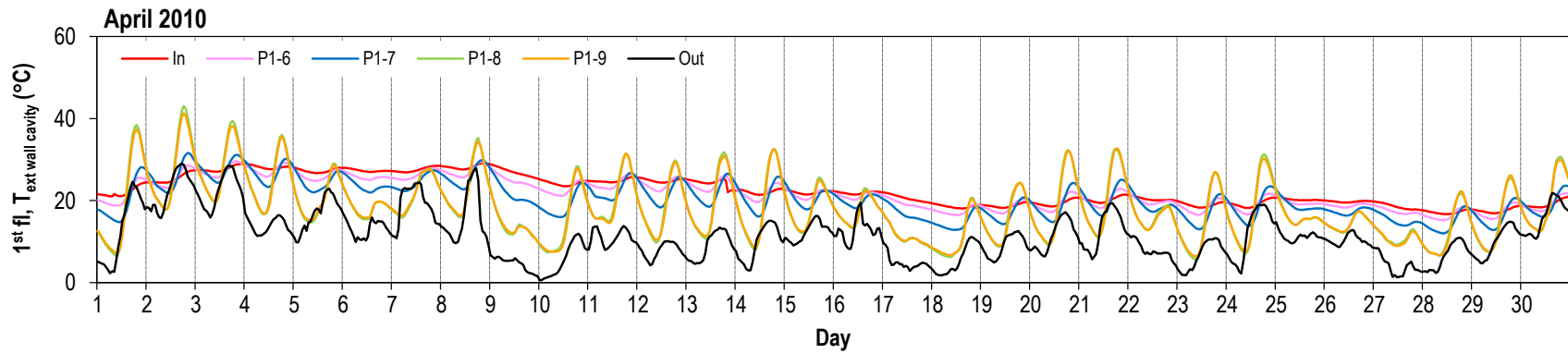
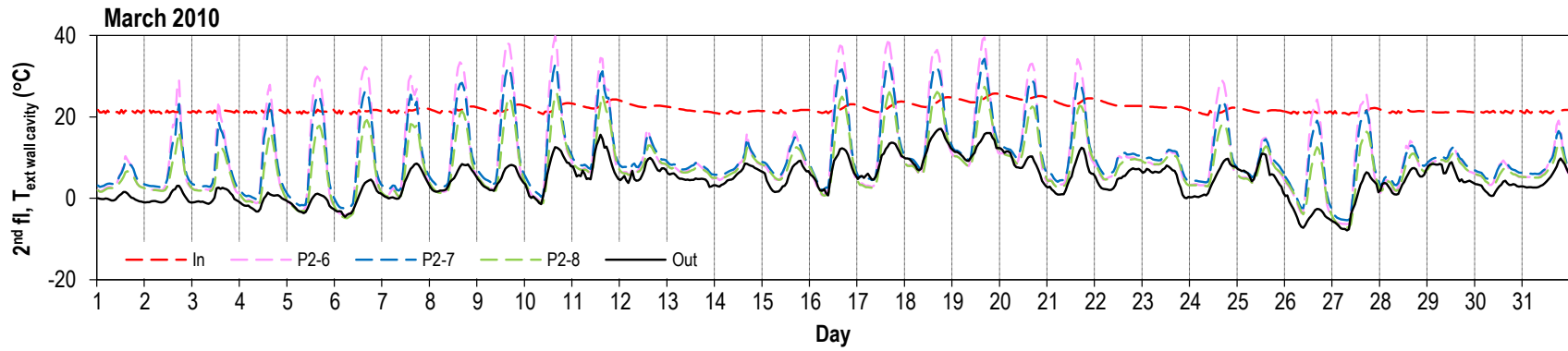
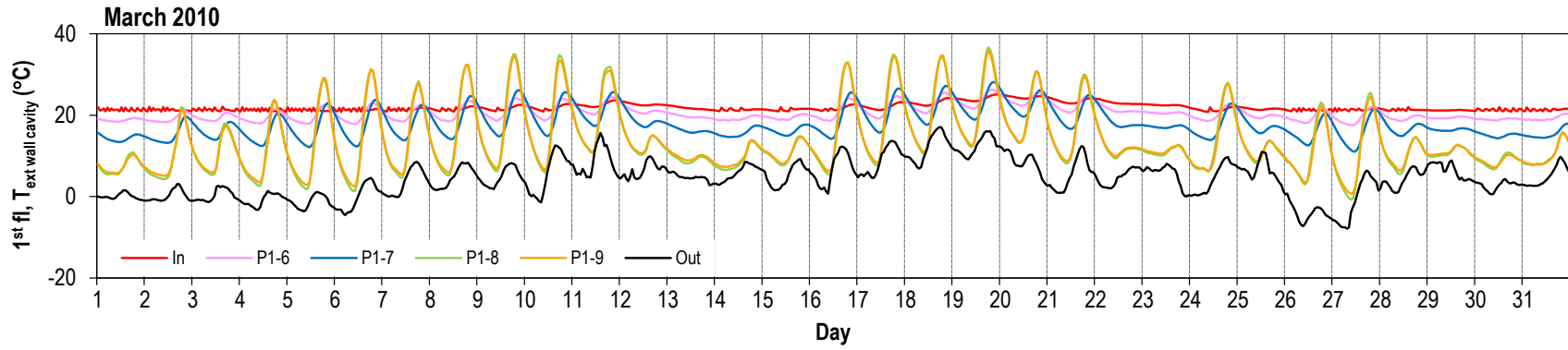

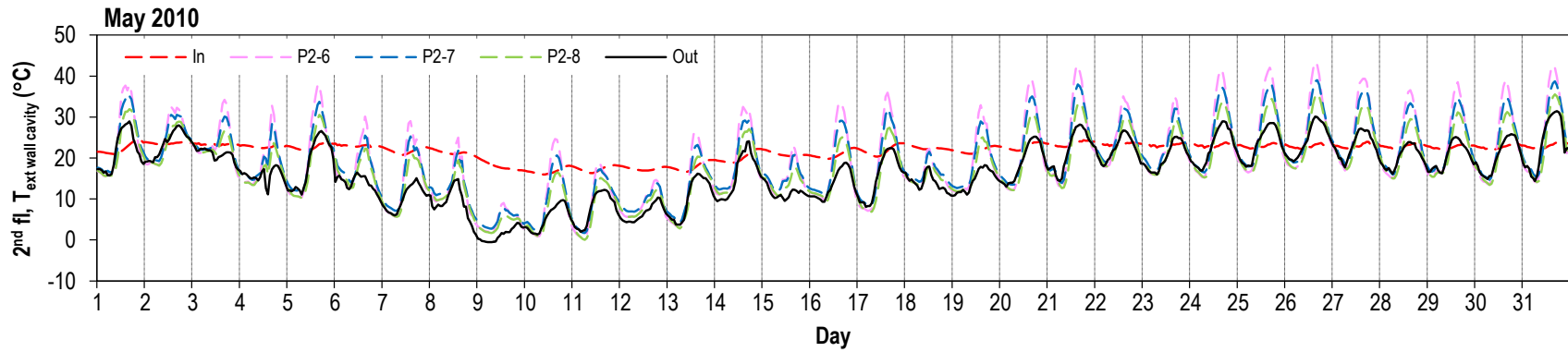
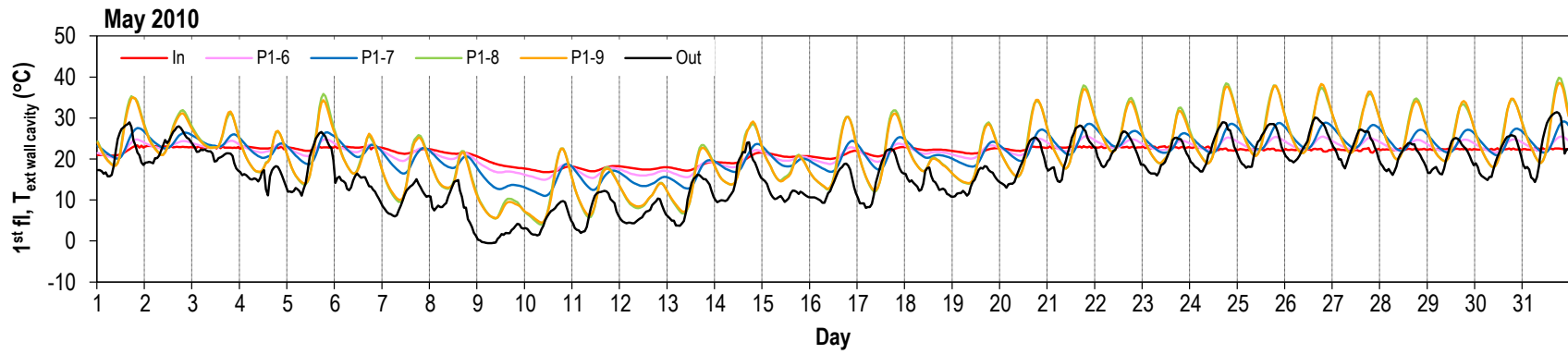
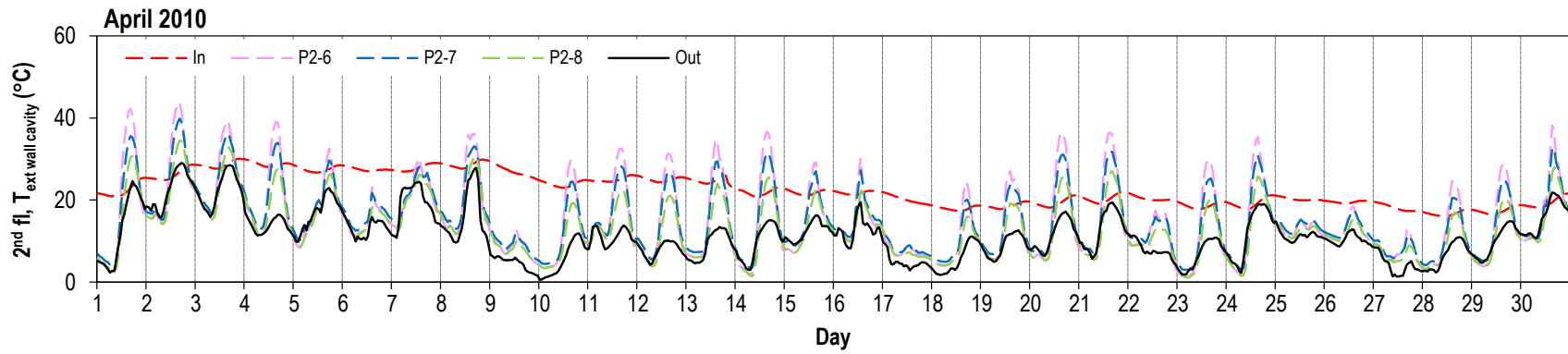

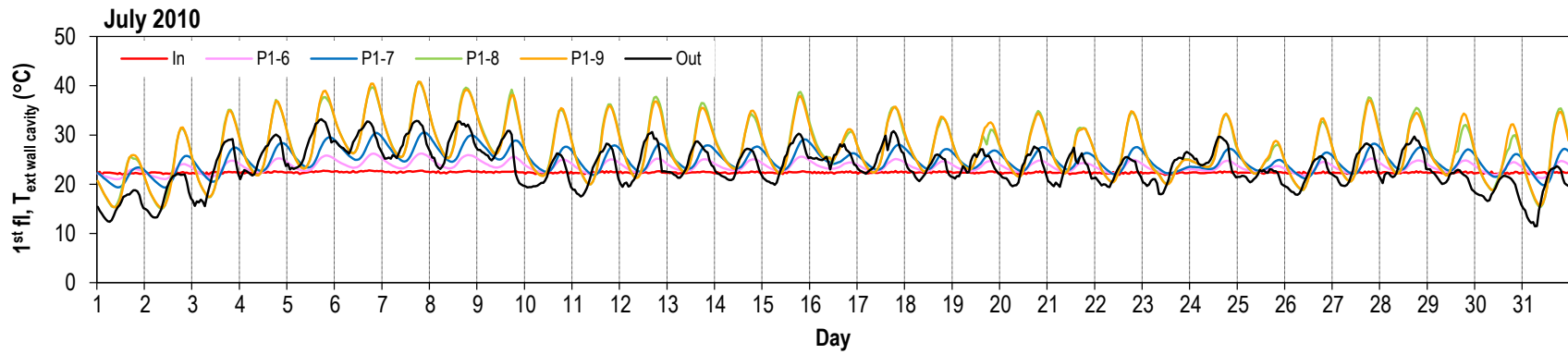
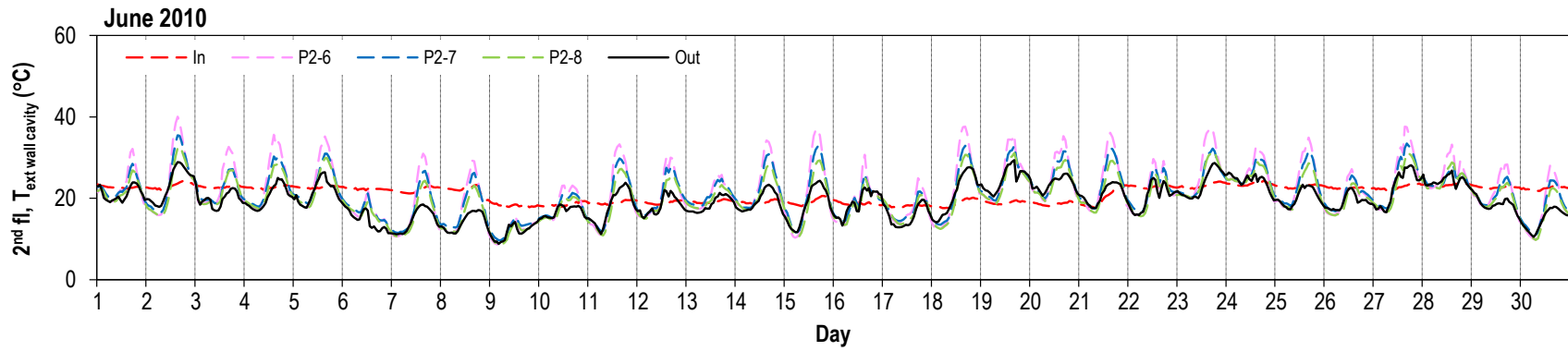
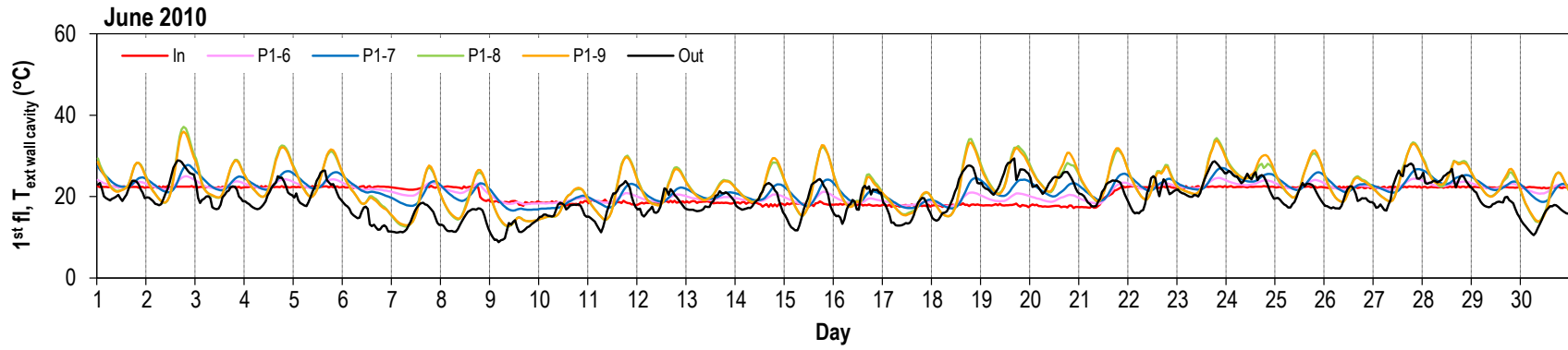

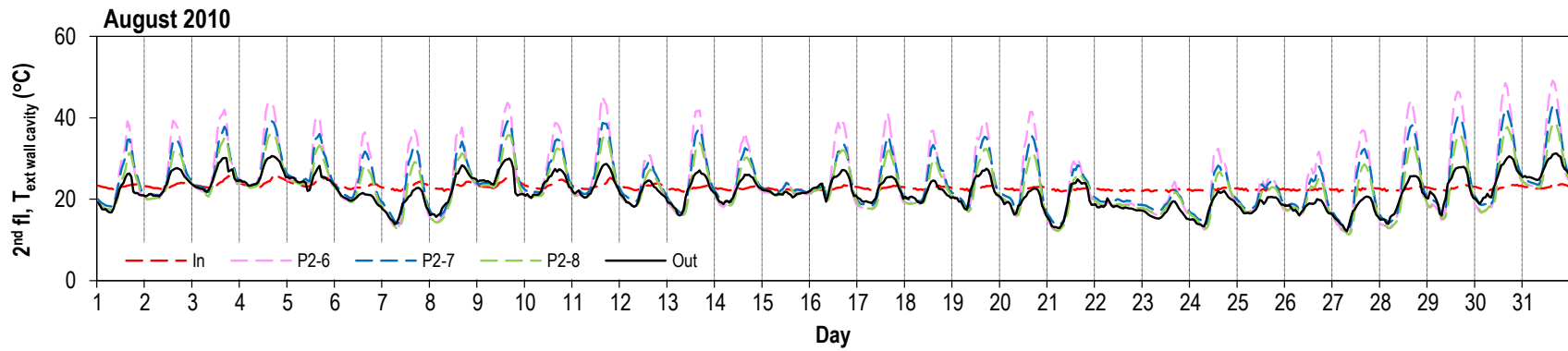
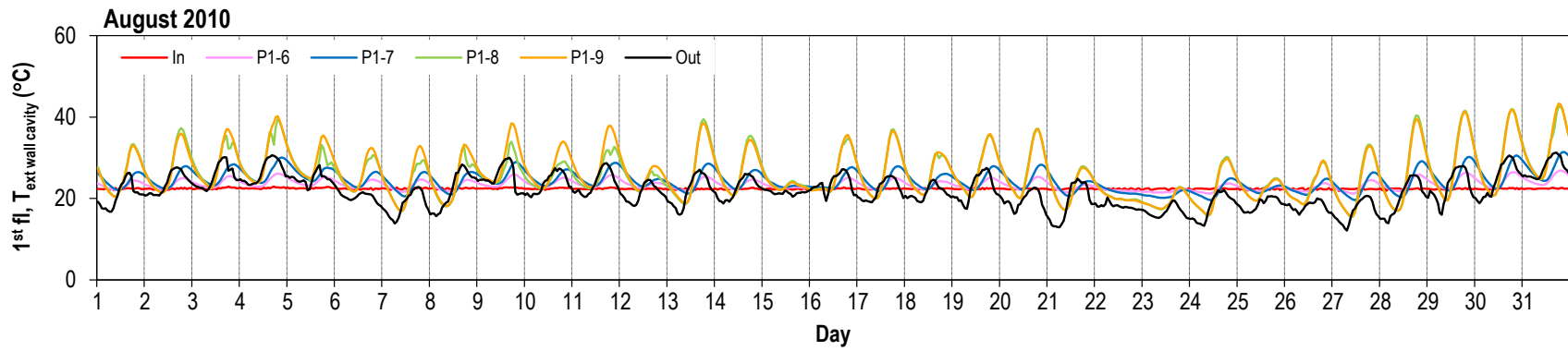
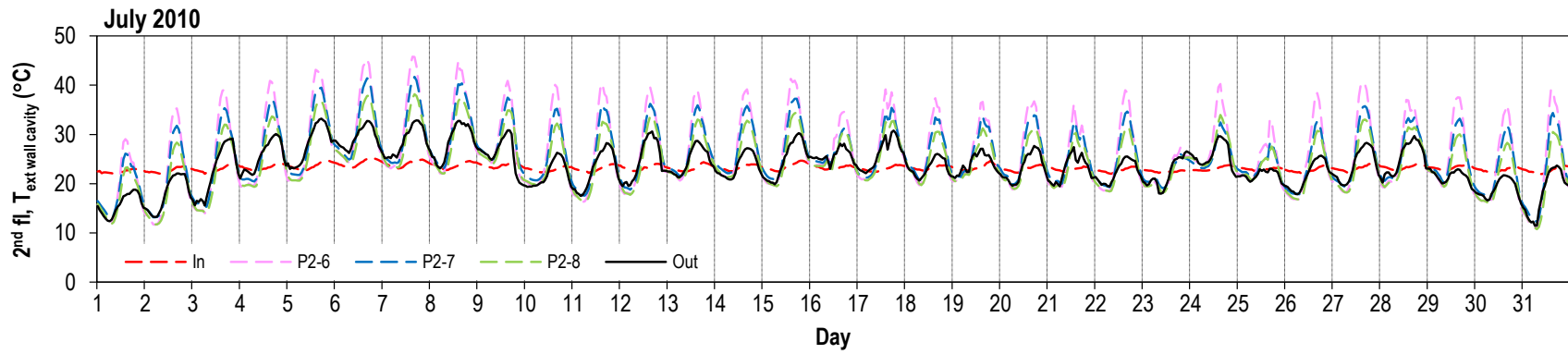

Temperature (°C) at interior side of stud cavity. Refer to Figures 25 thru 28 for sensor location.

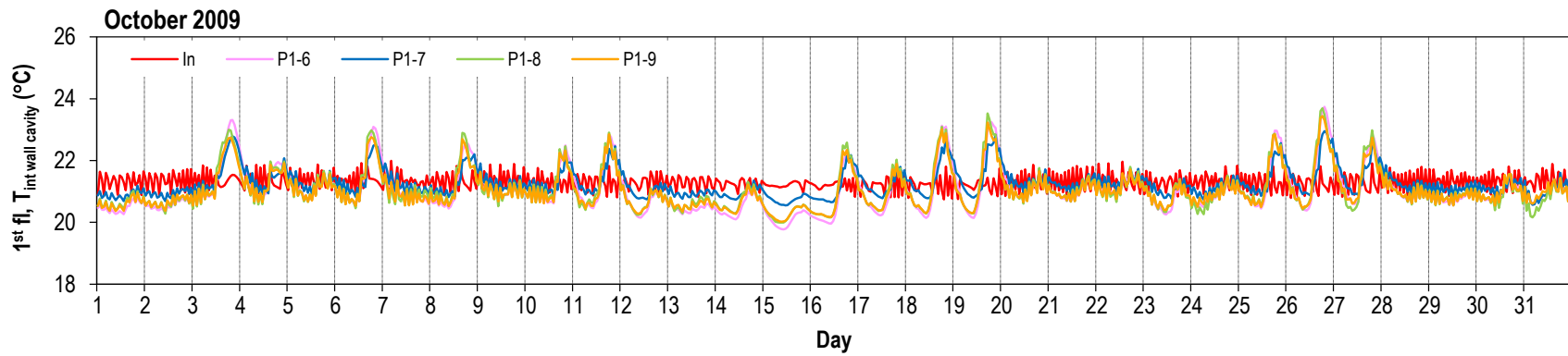
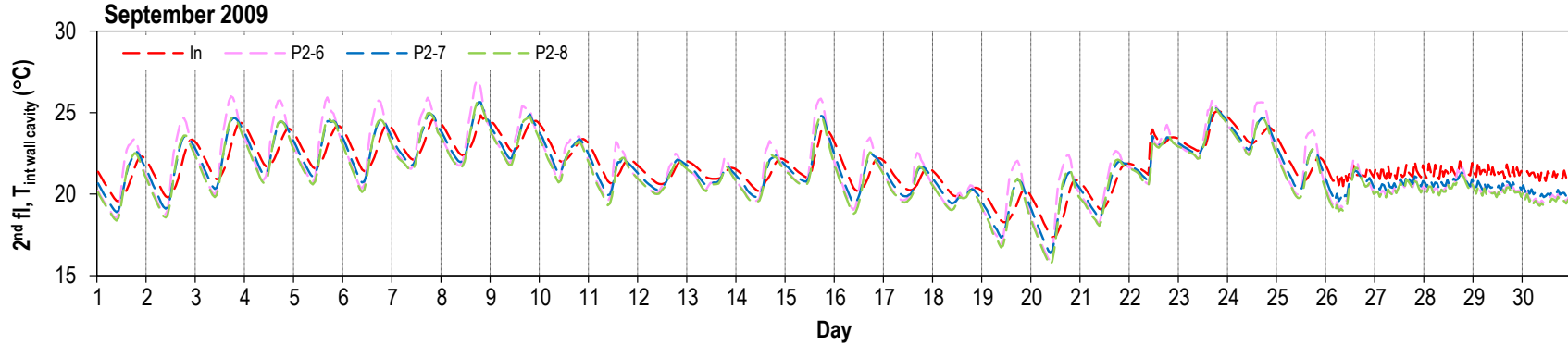
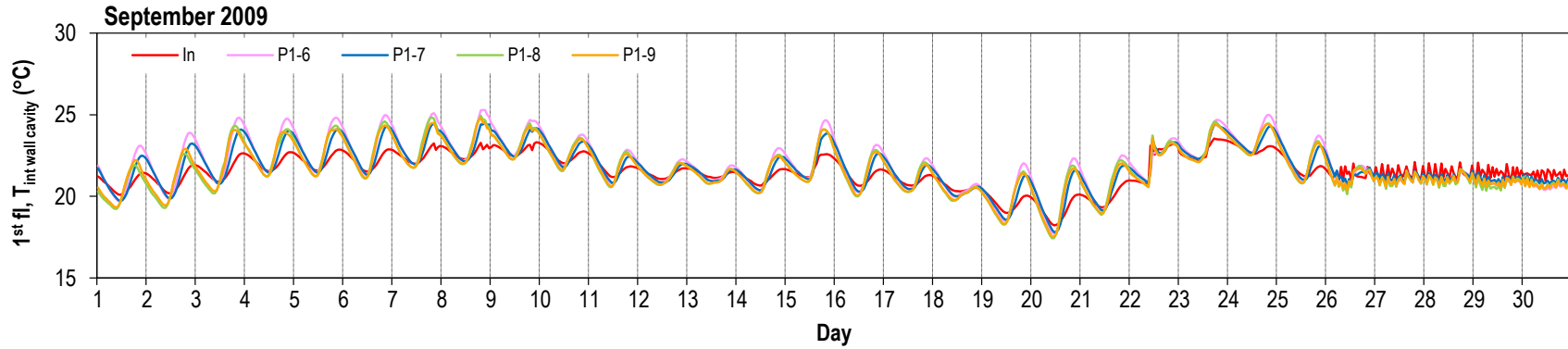

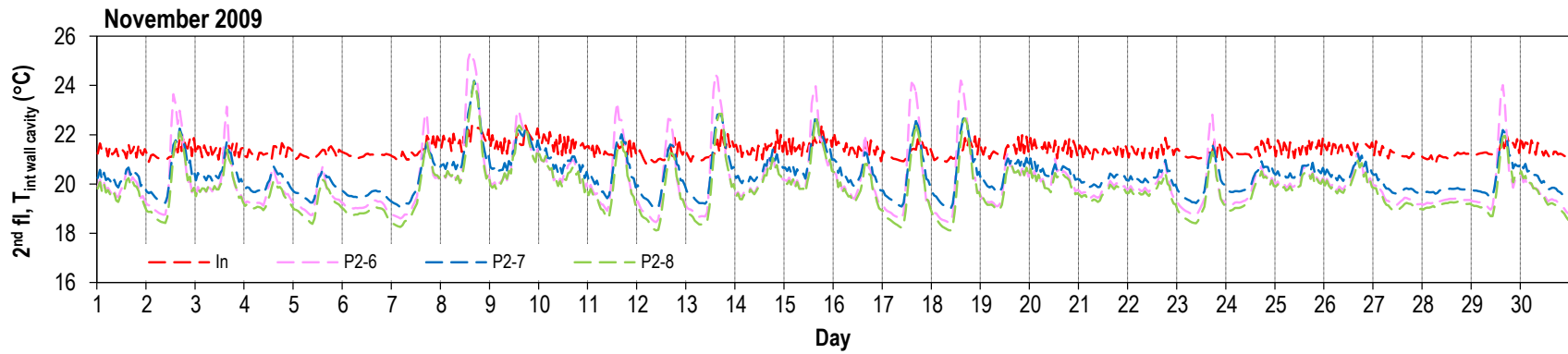
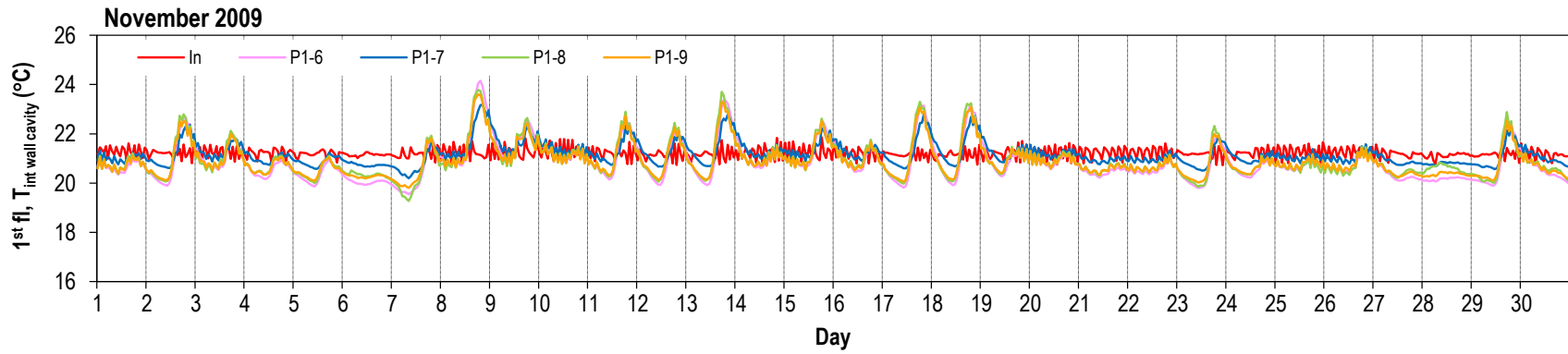
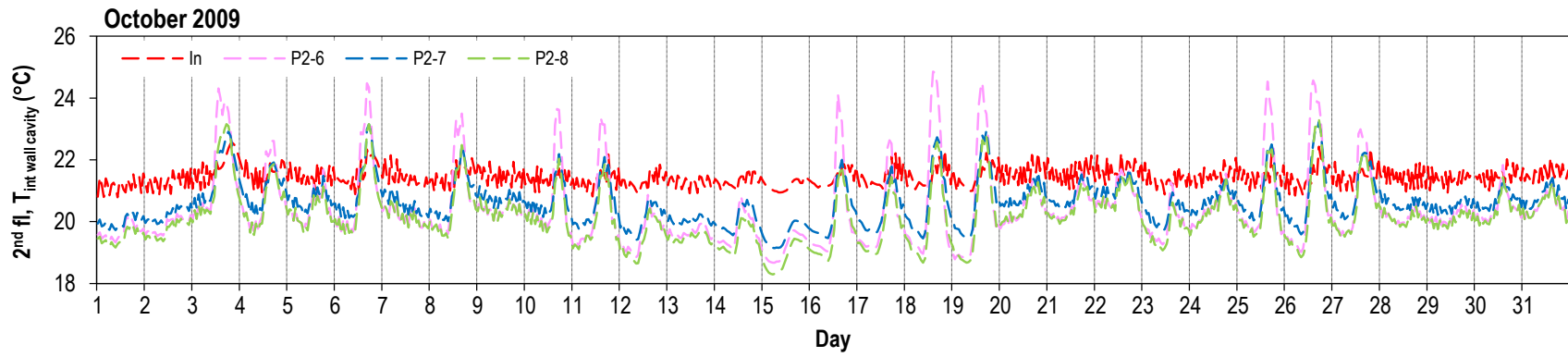

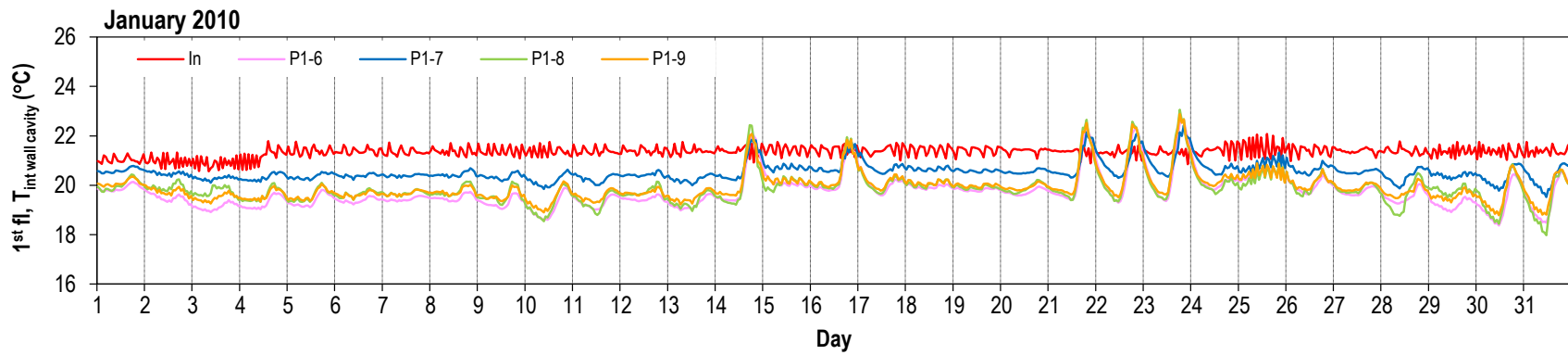
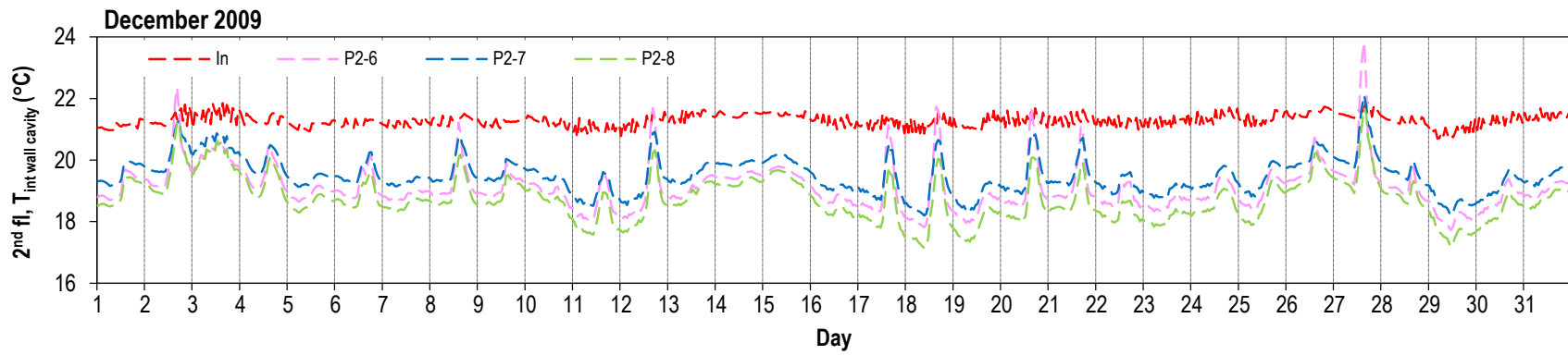
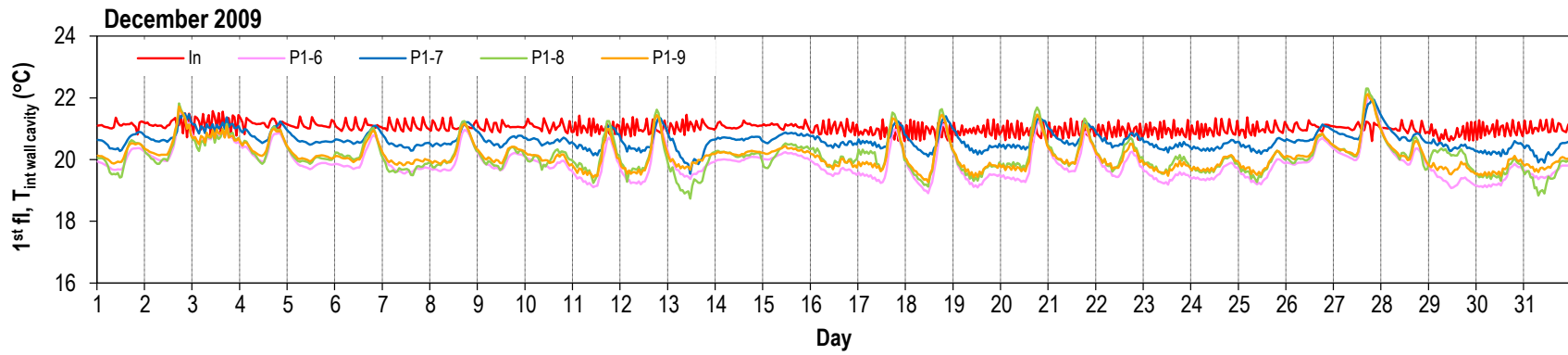

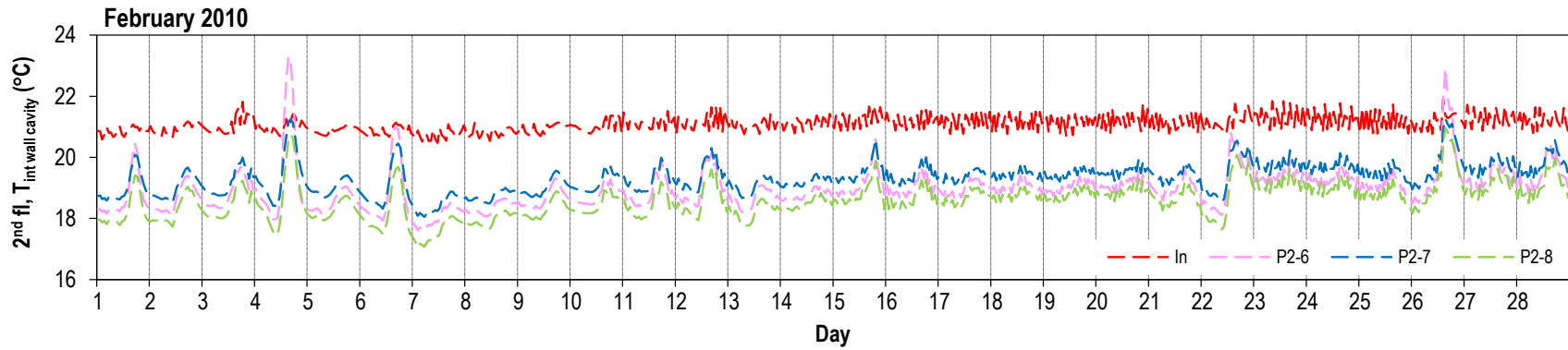
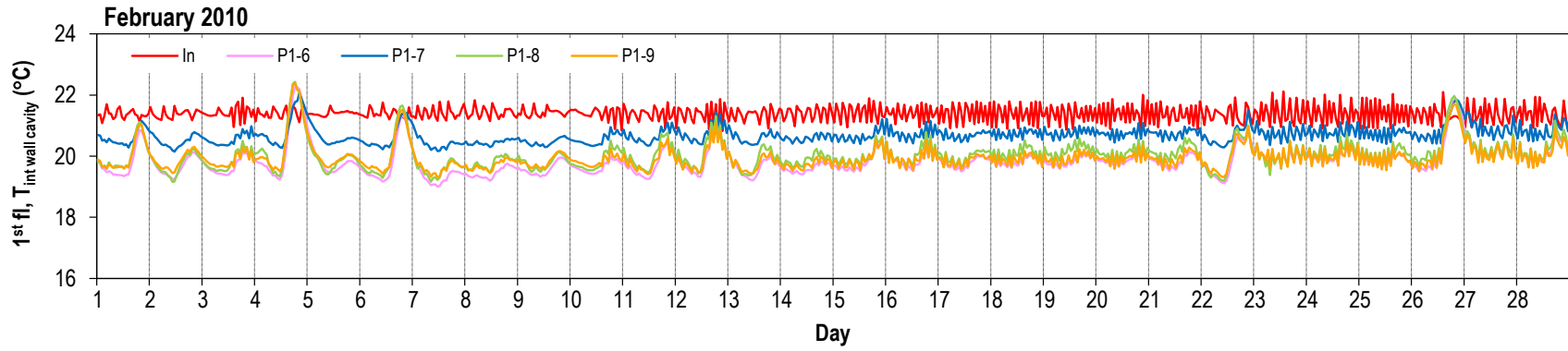
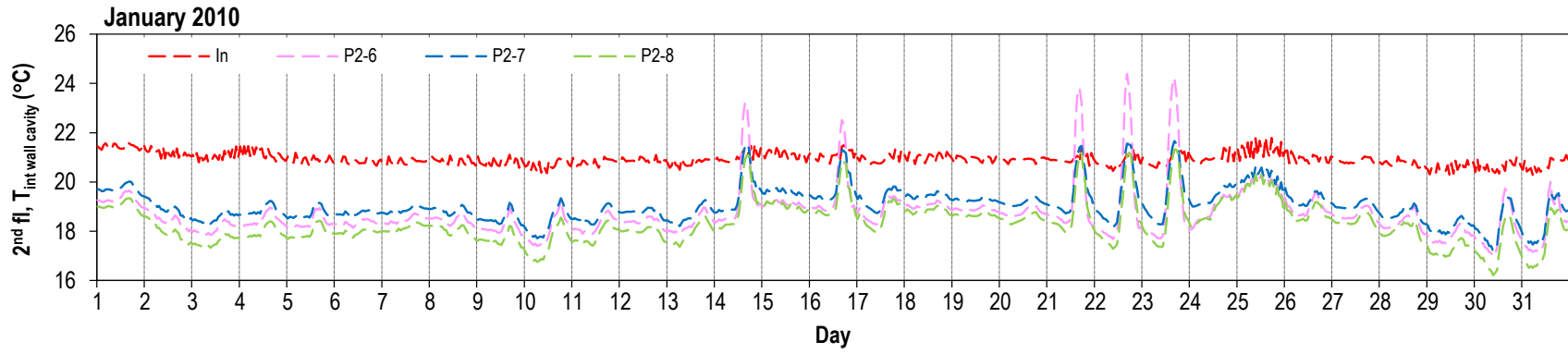

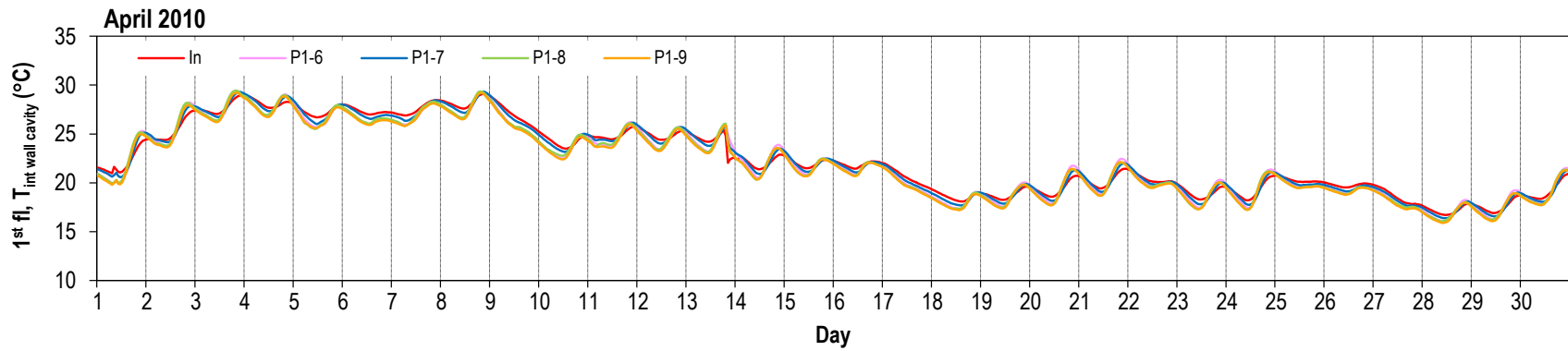
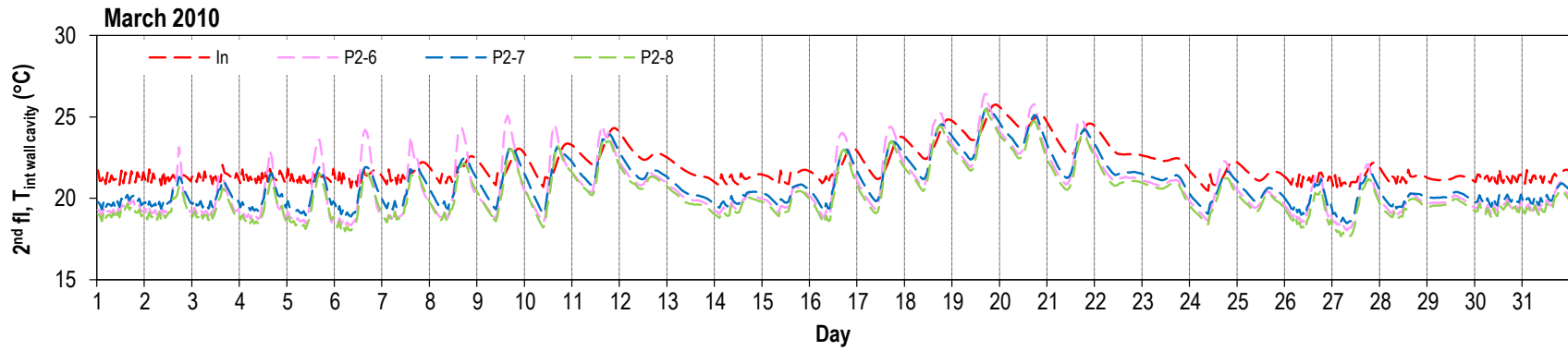
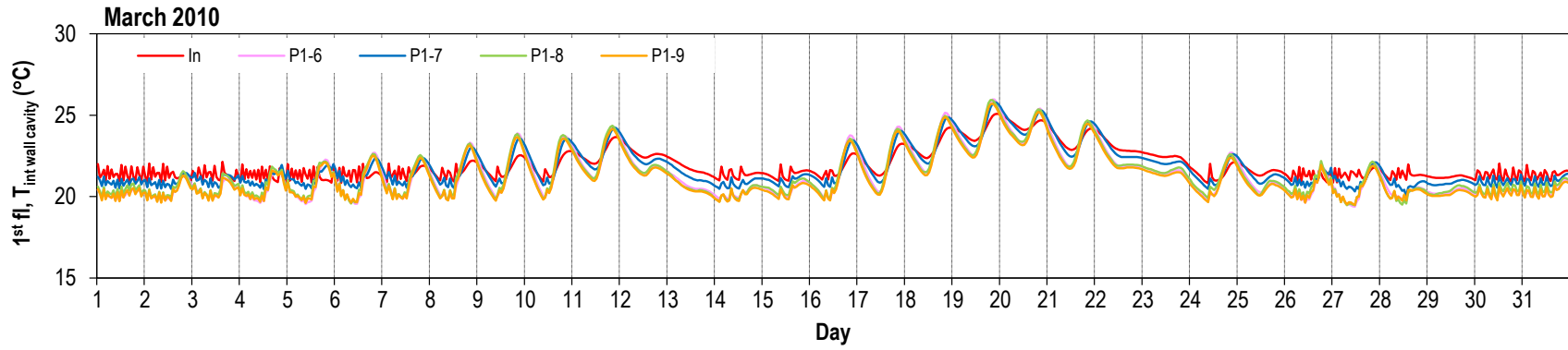

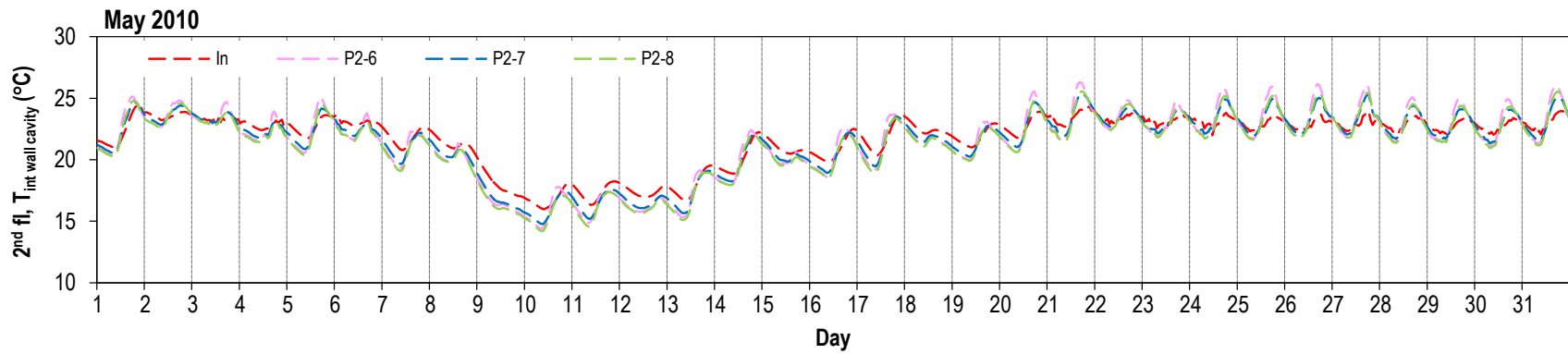
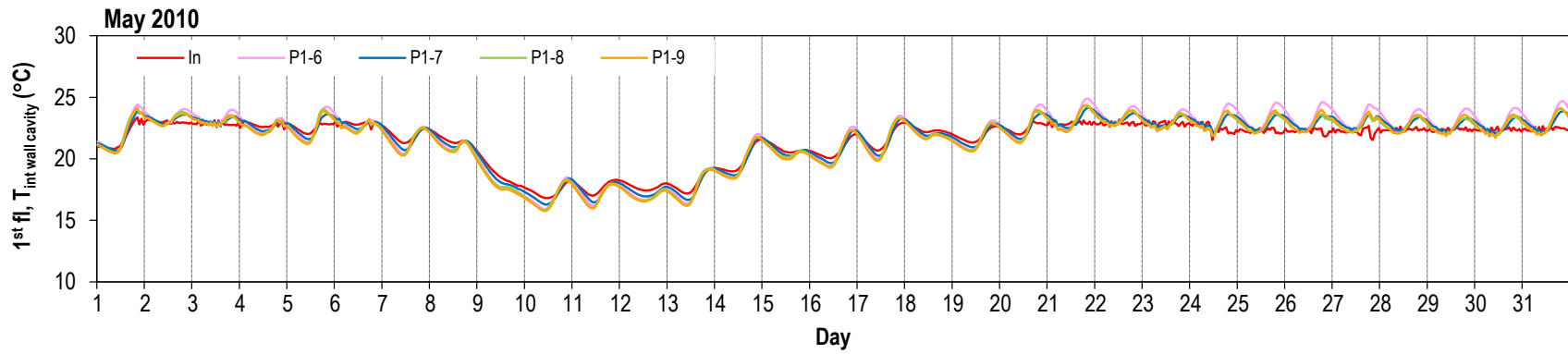
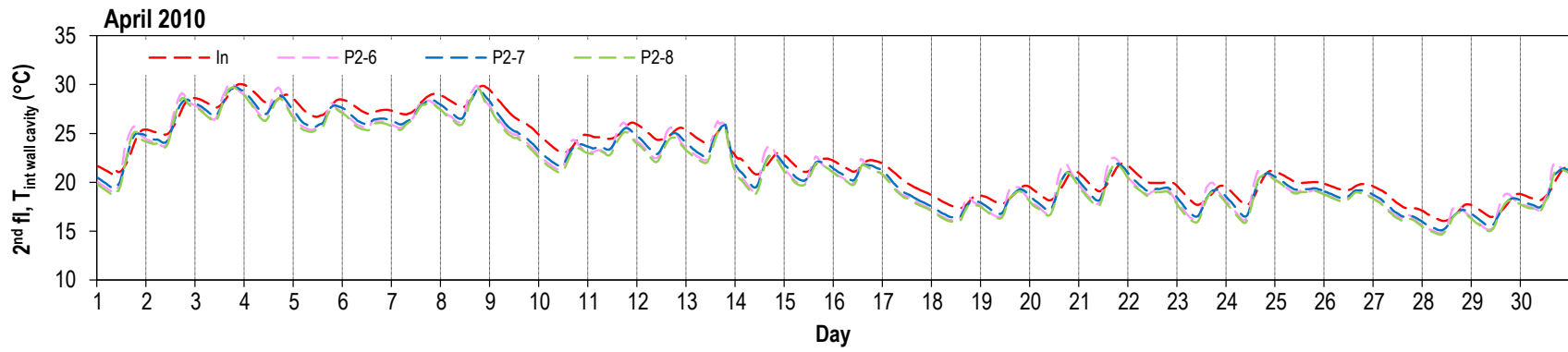

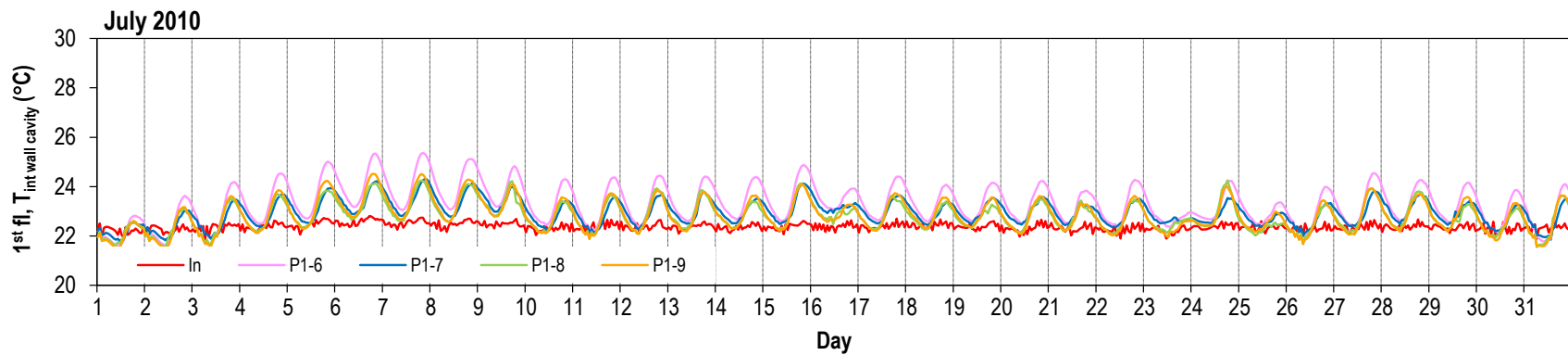
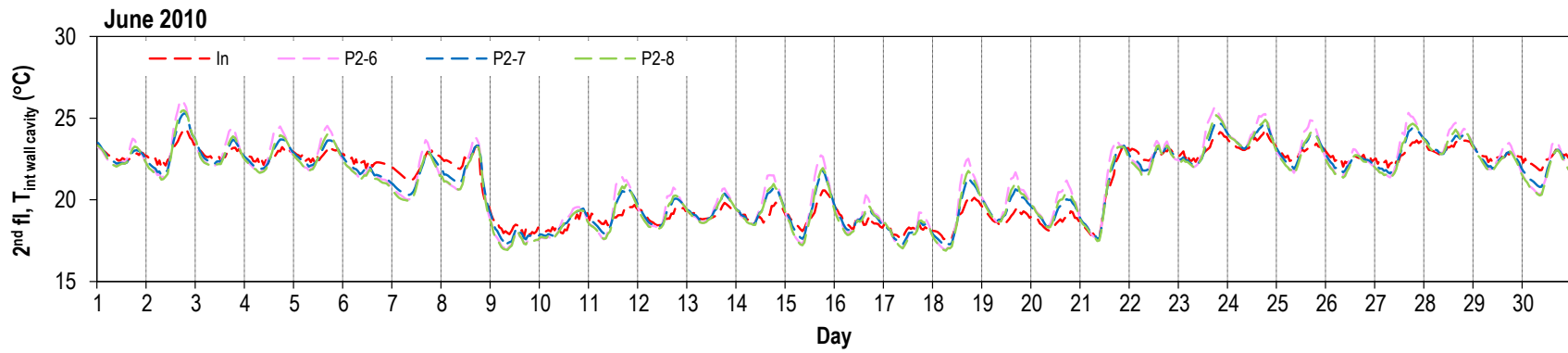
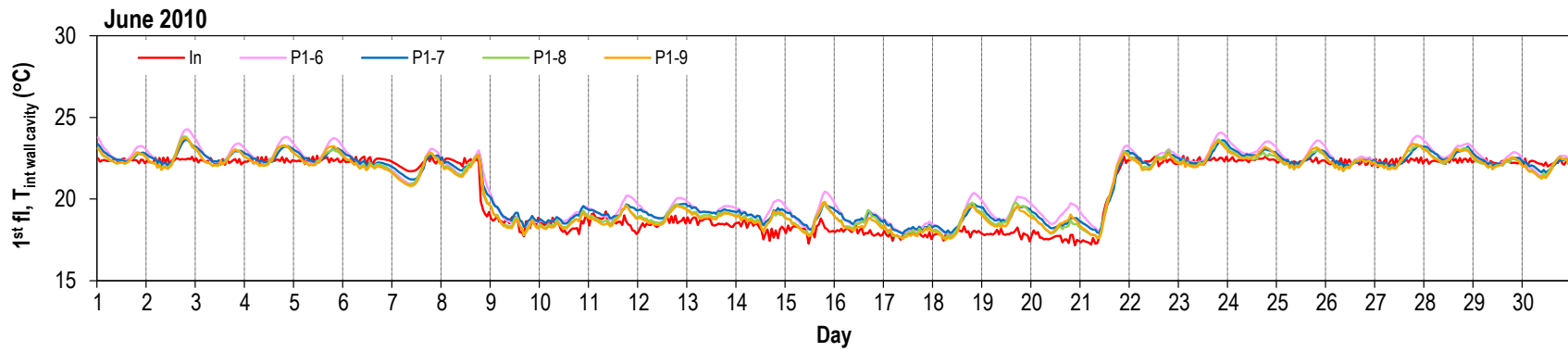

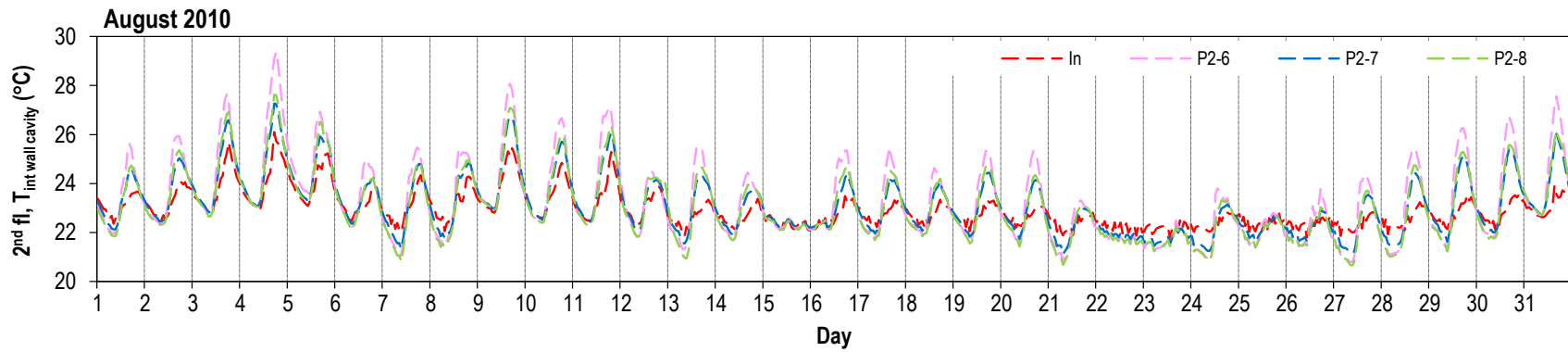
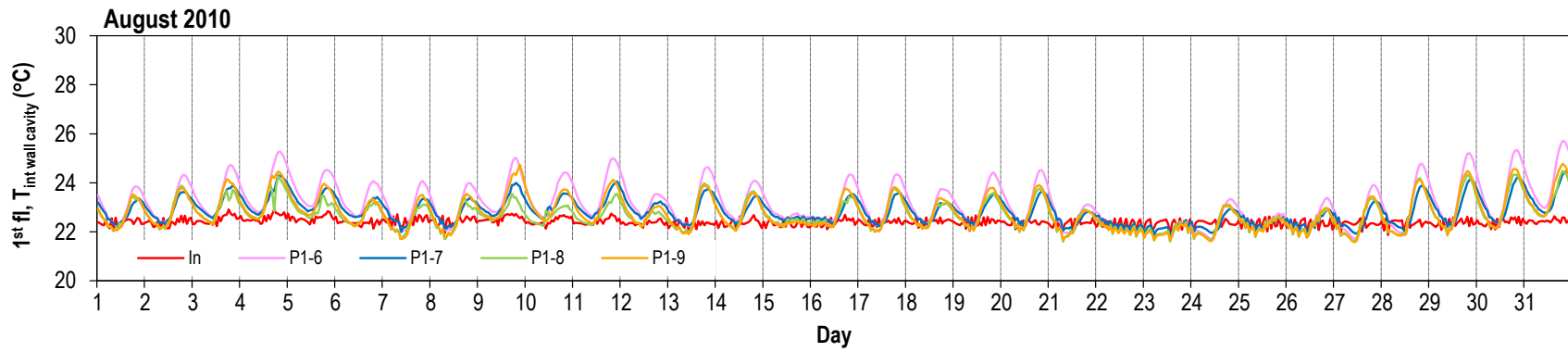
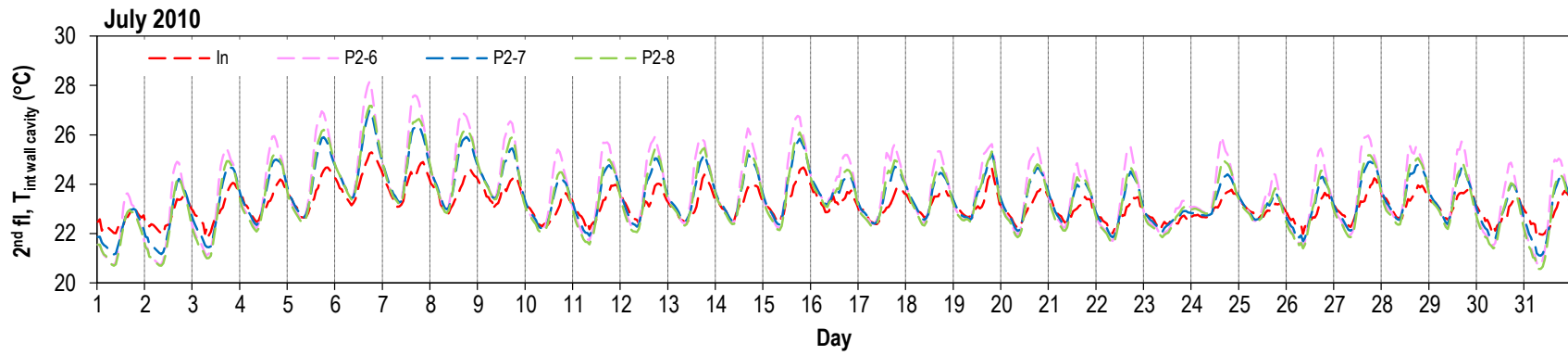

Relative humidity (%) at exterior side of stud cavity. Refer to Figures 25 thru 28 for sensor location.

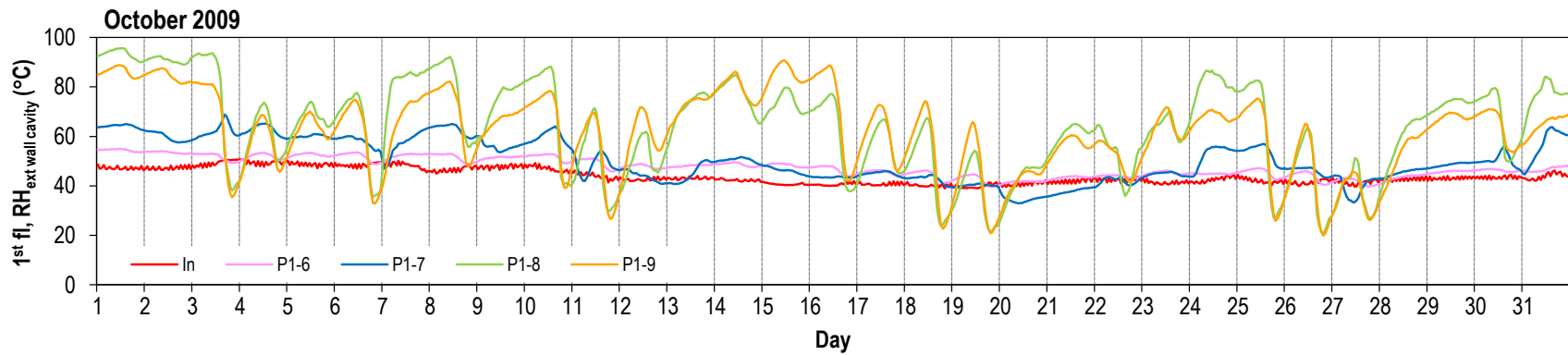
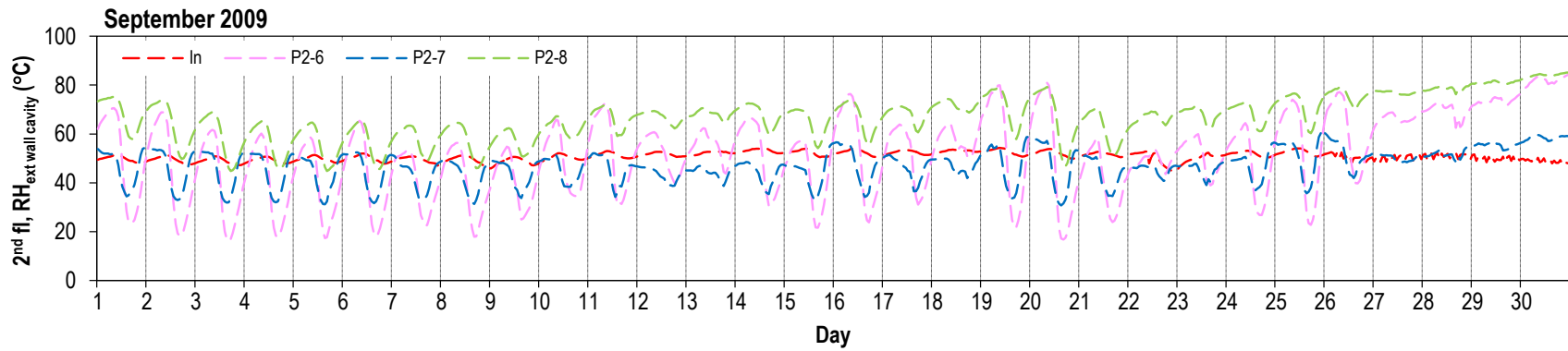
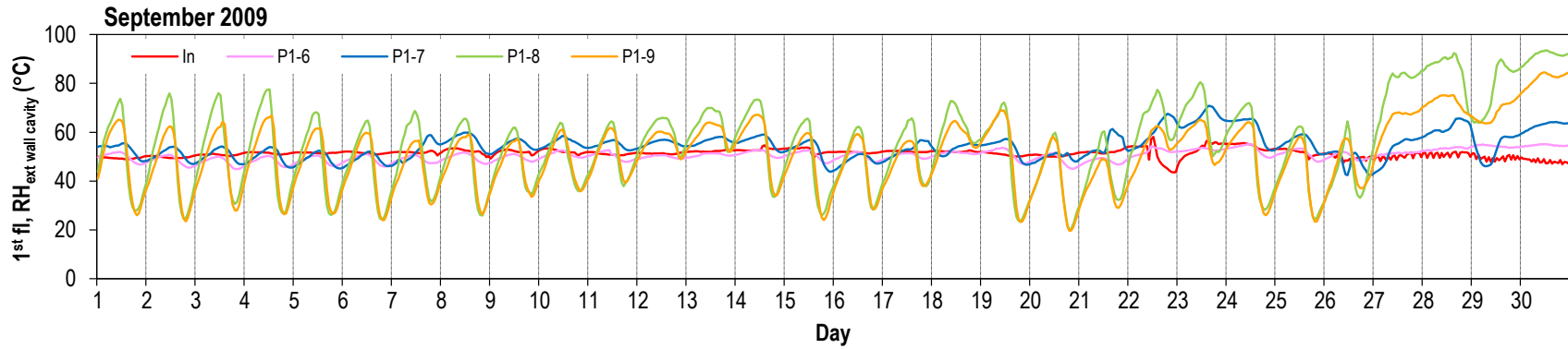

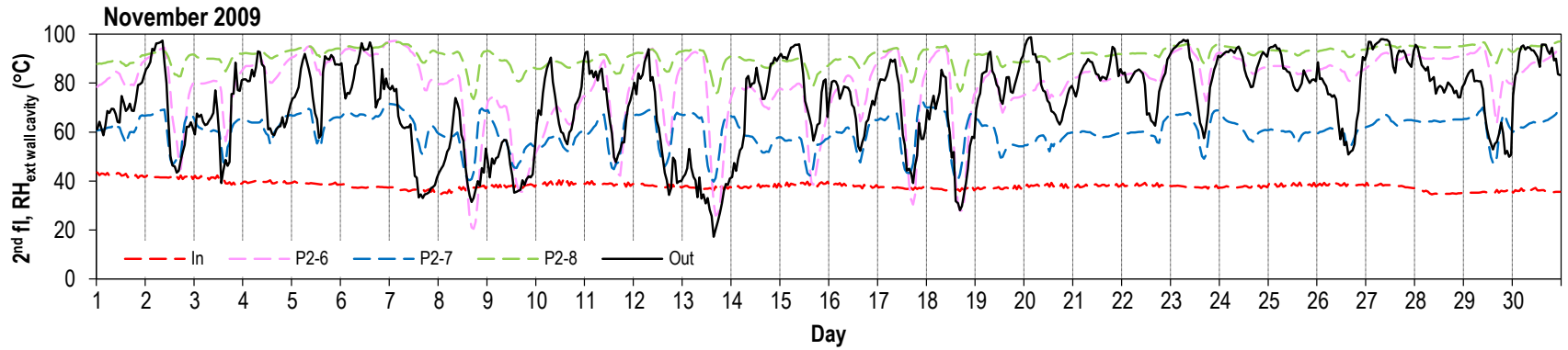
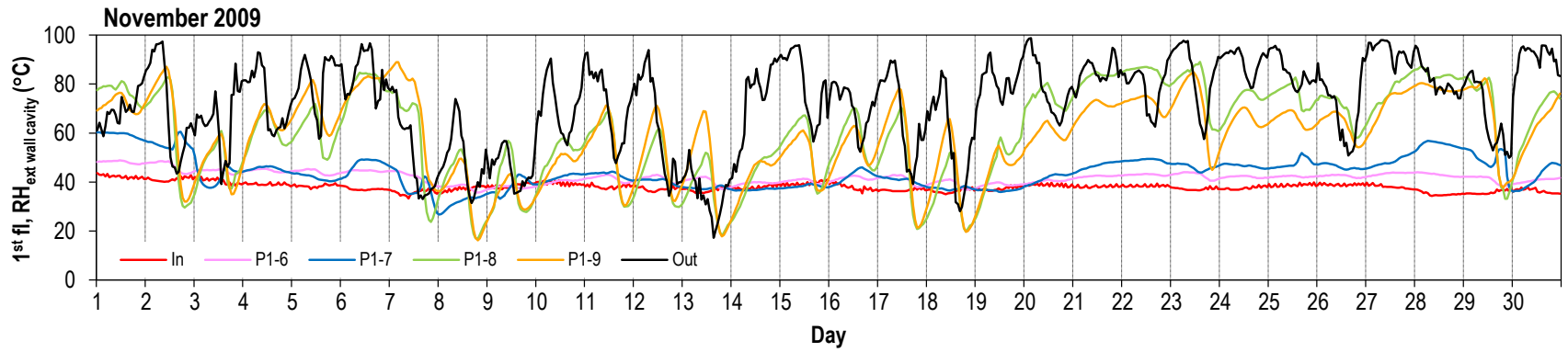
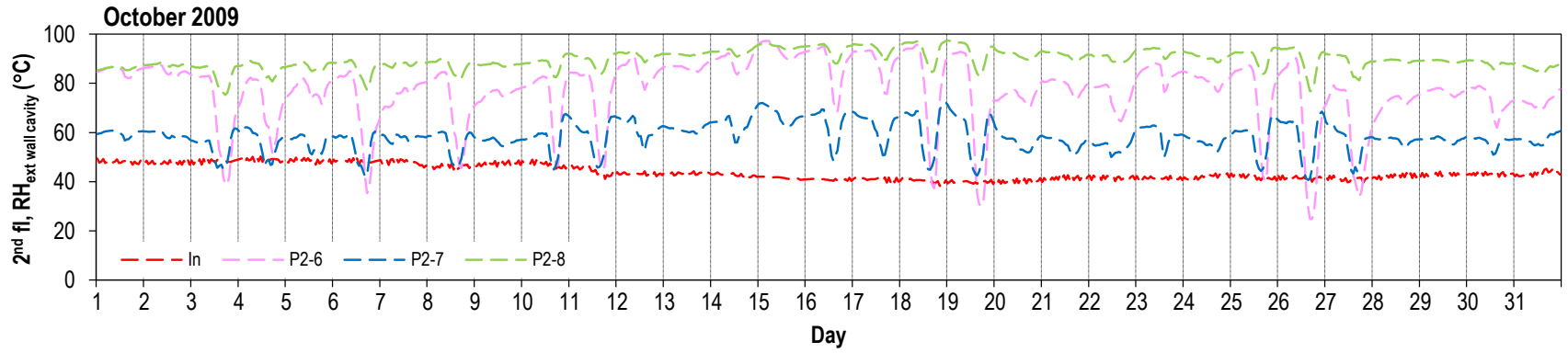

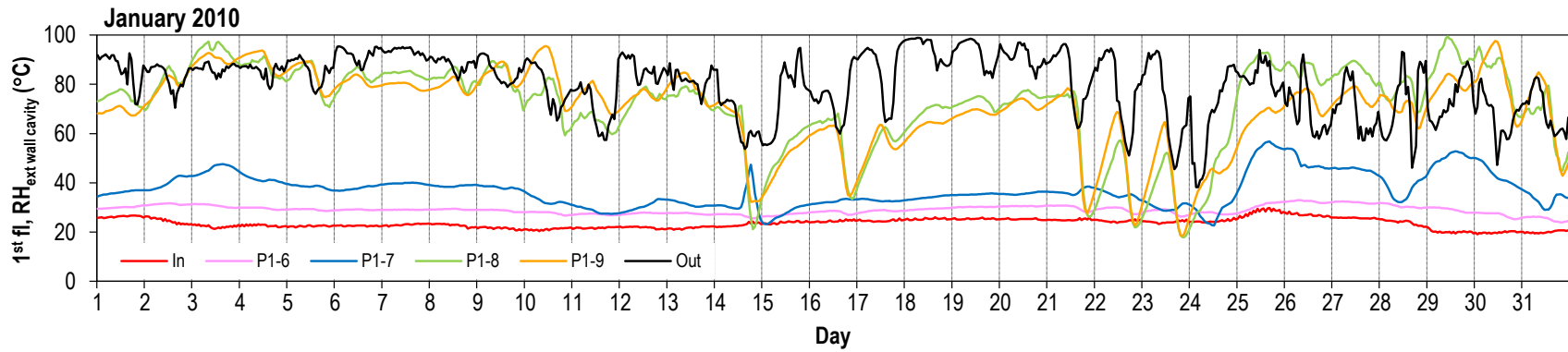
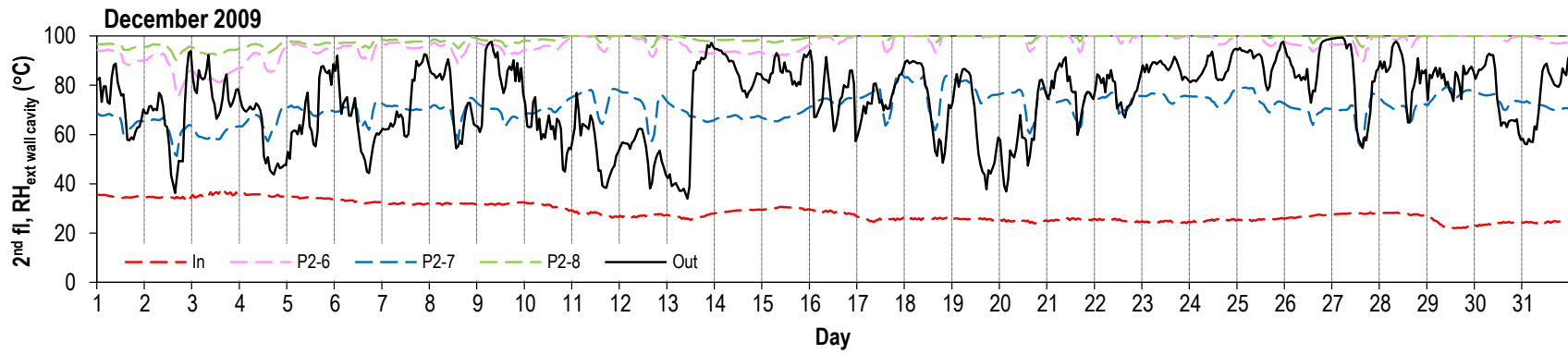
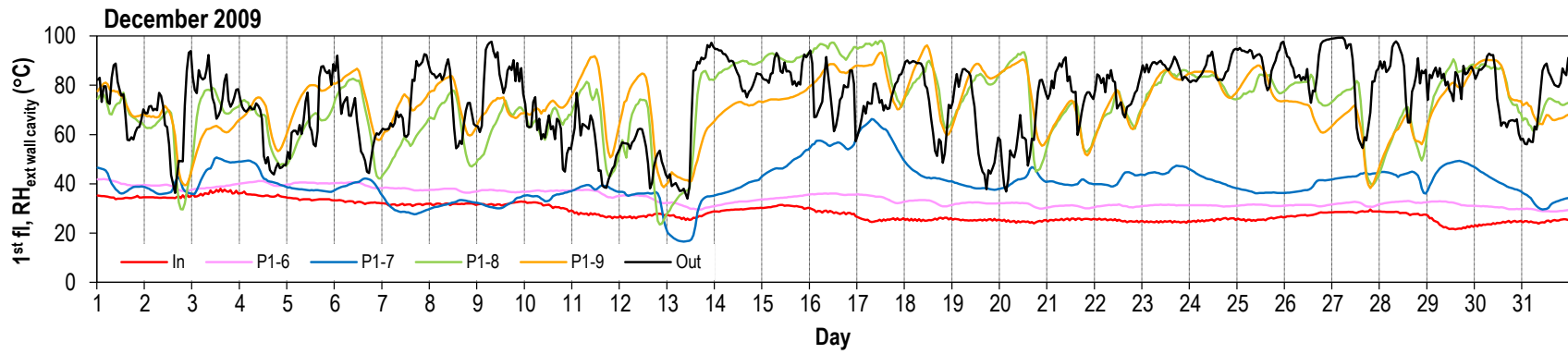

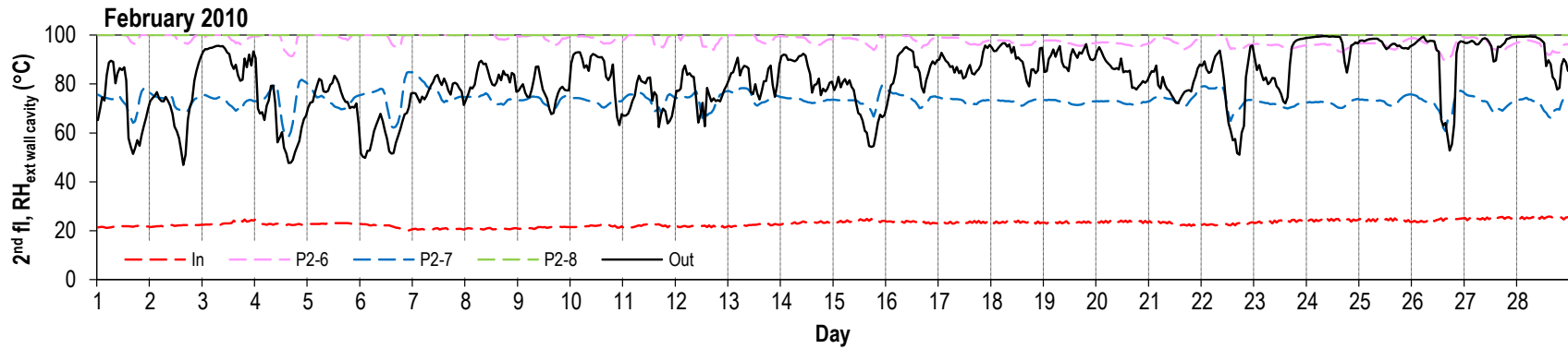
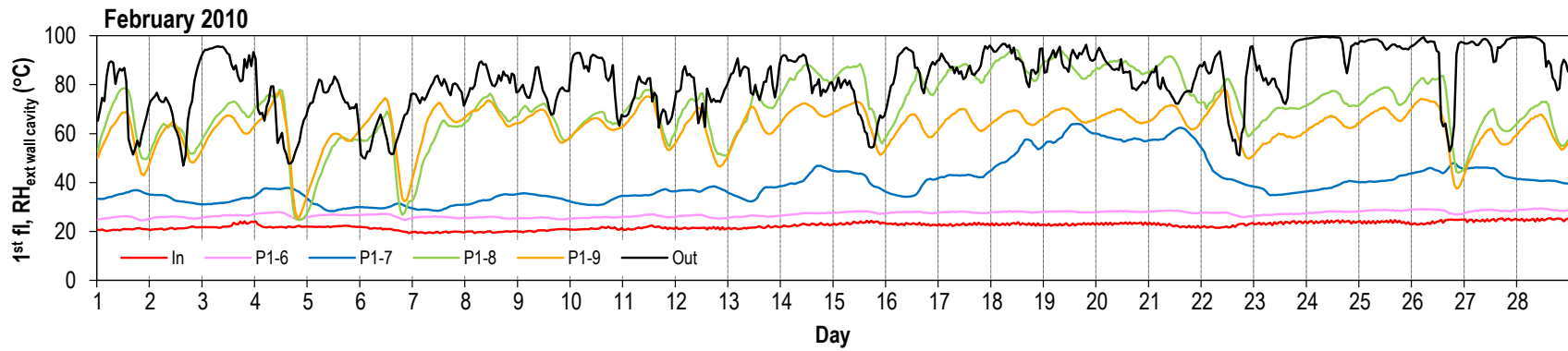
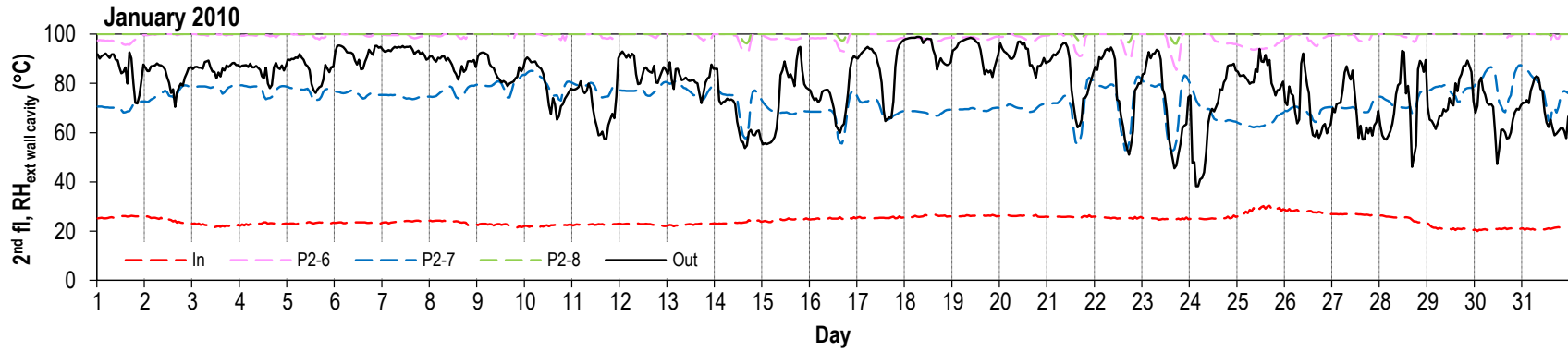

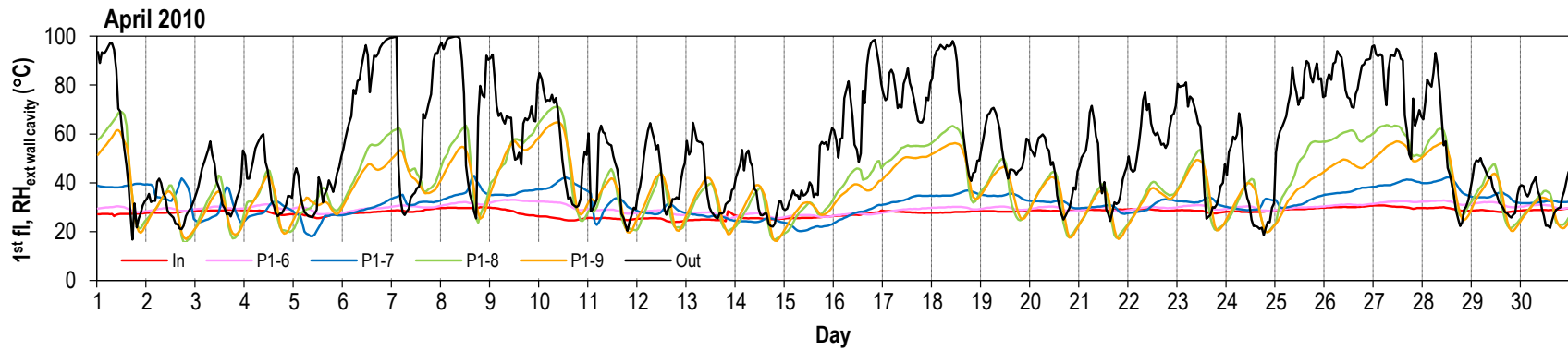
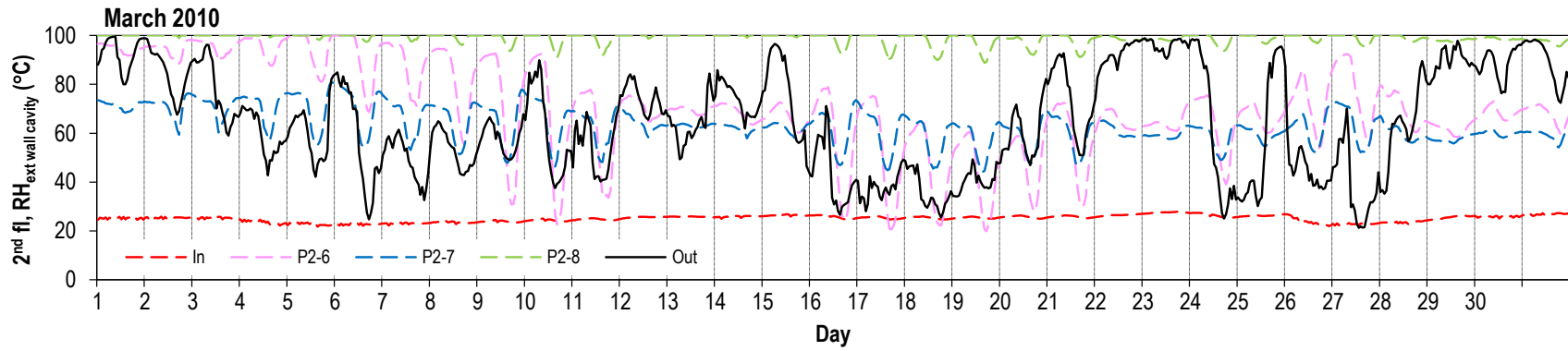
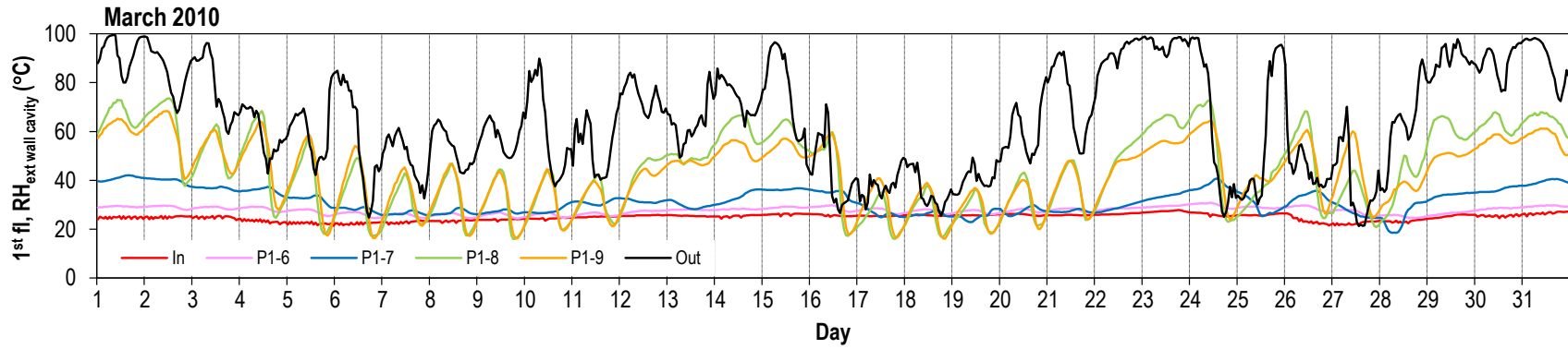

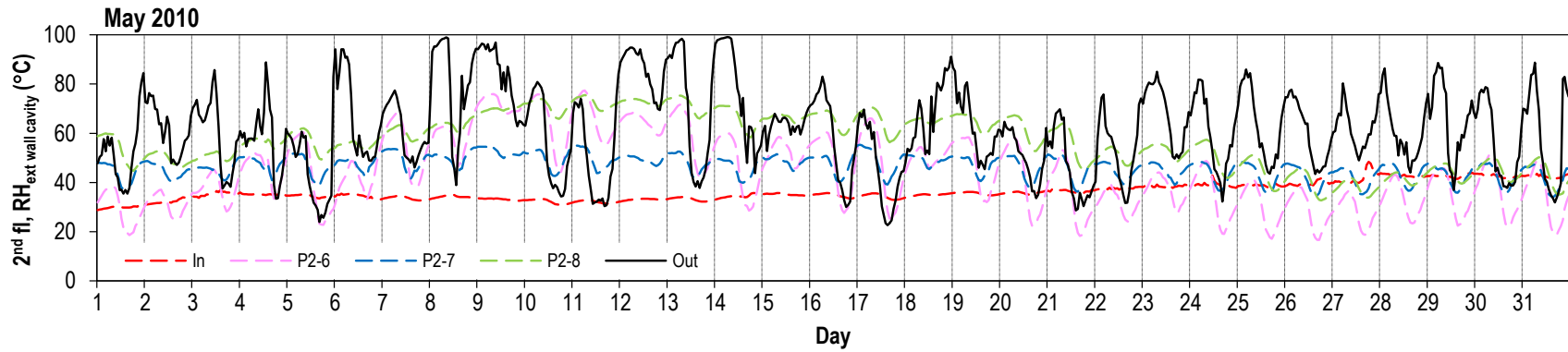
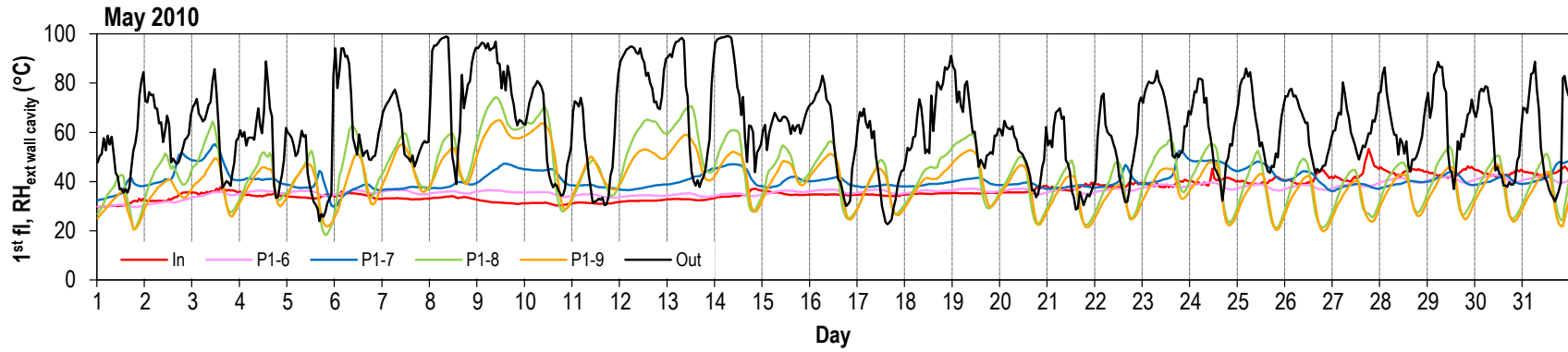
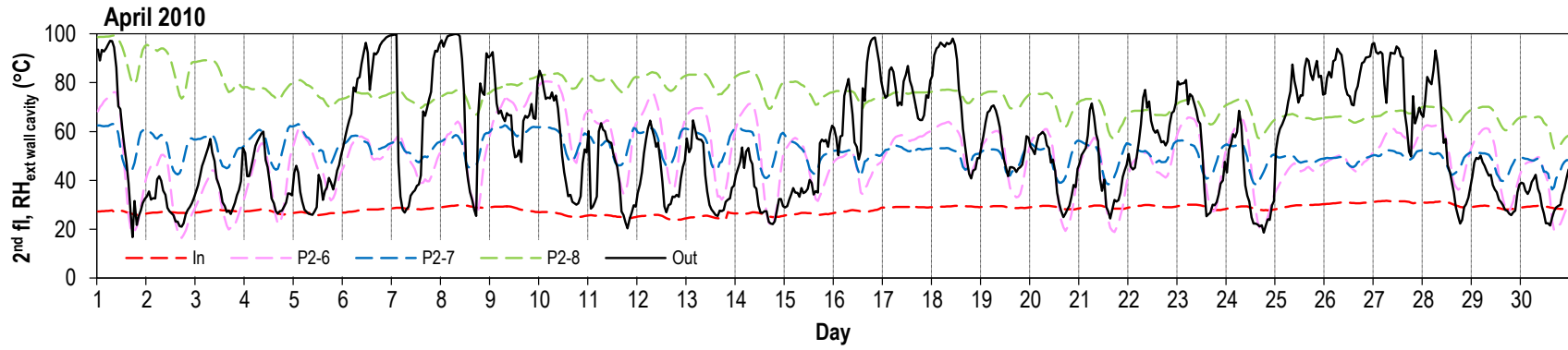

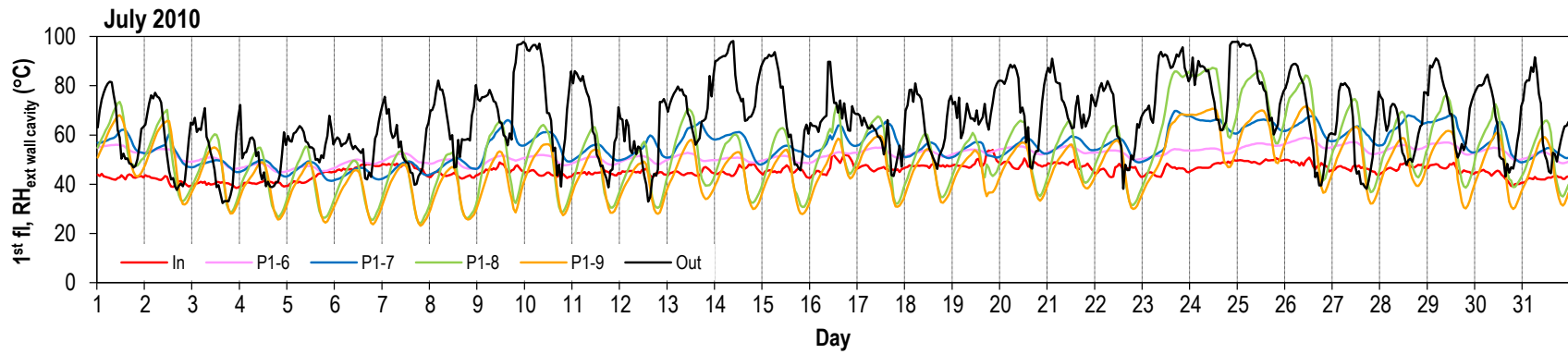
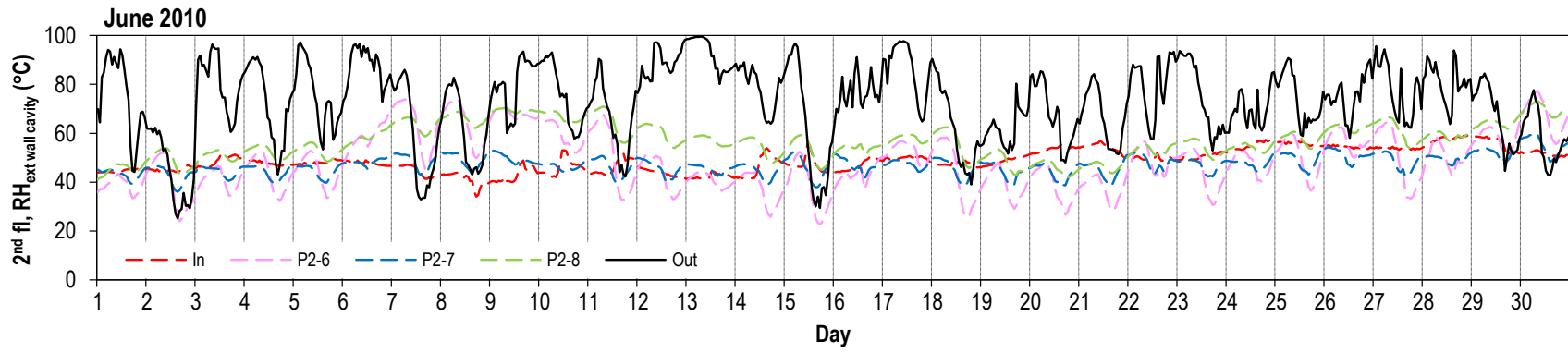
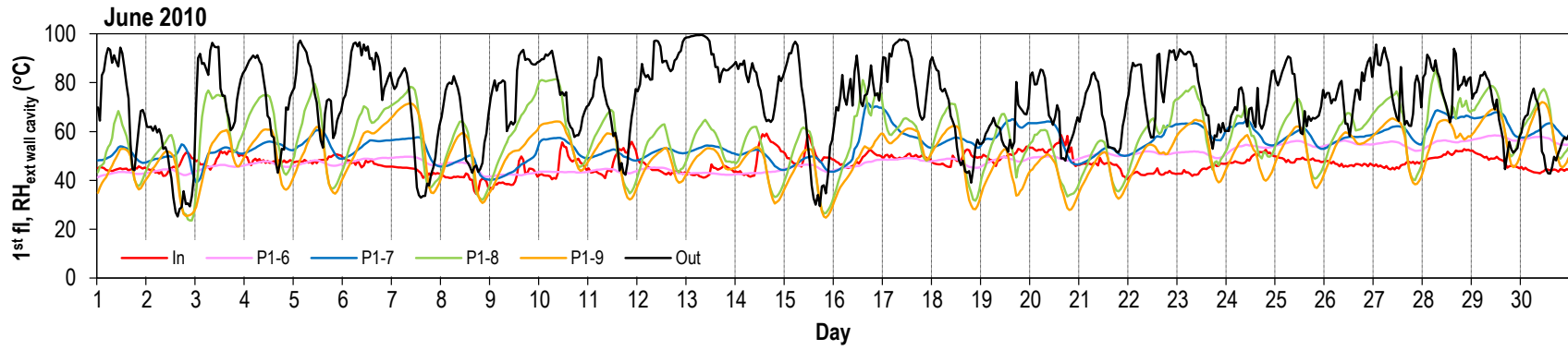

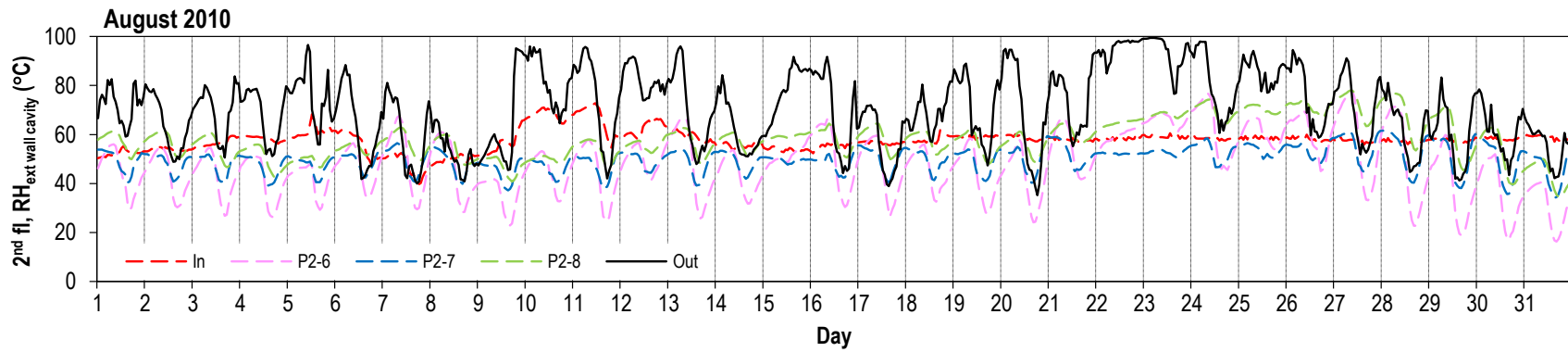
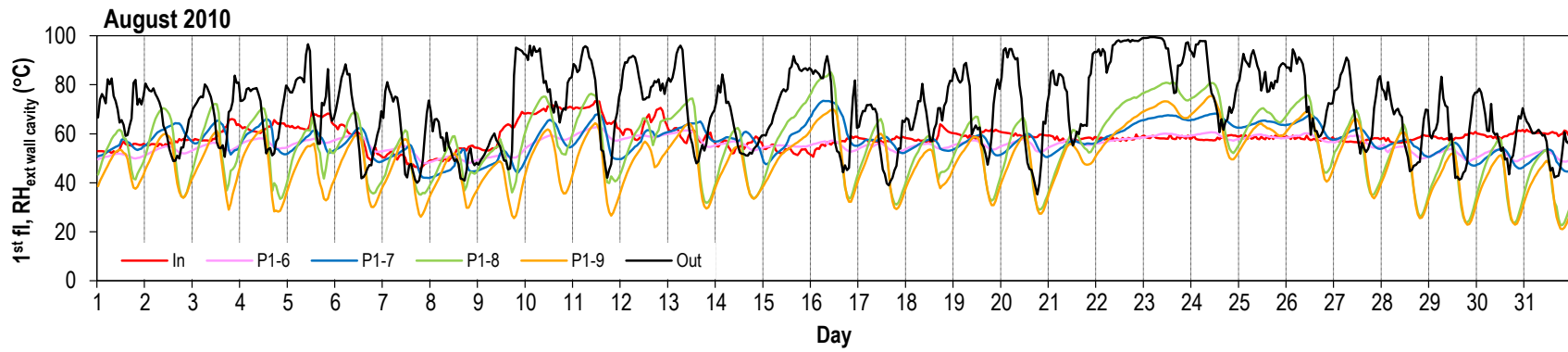
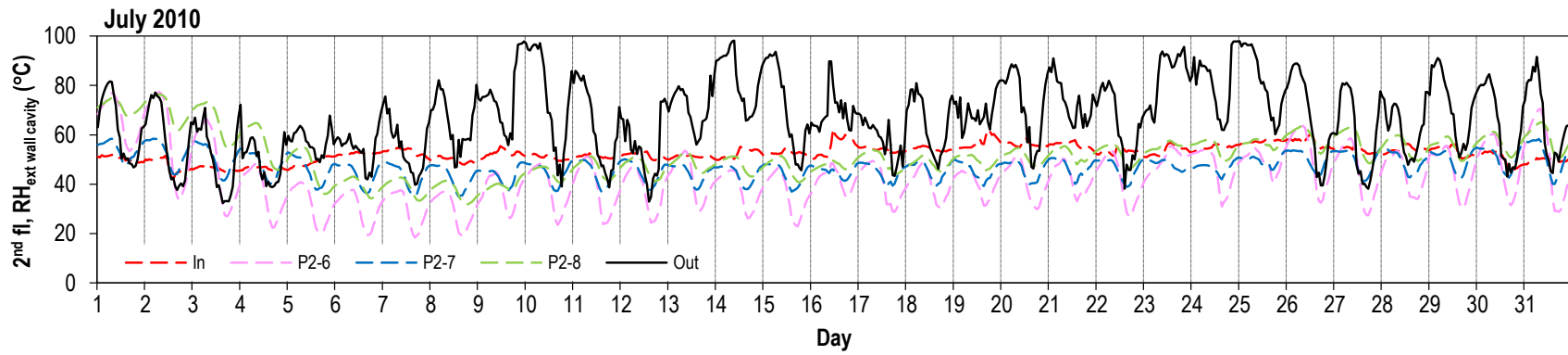

Water vapor pressure (kPa) at exterior side of stud cavity. Refer to Figures 25 thru 28 for sensor location.

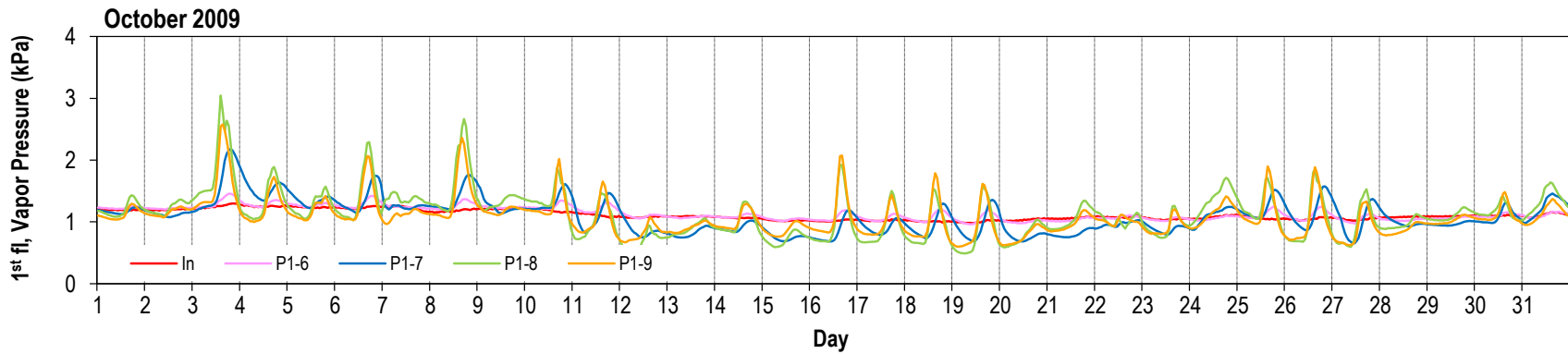
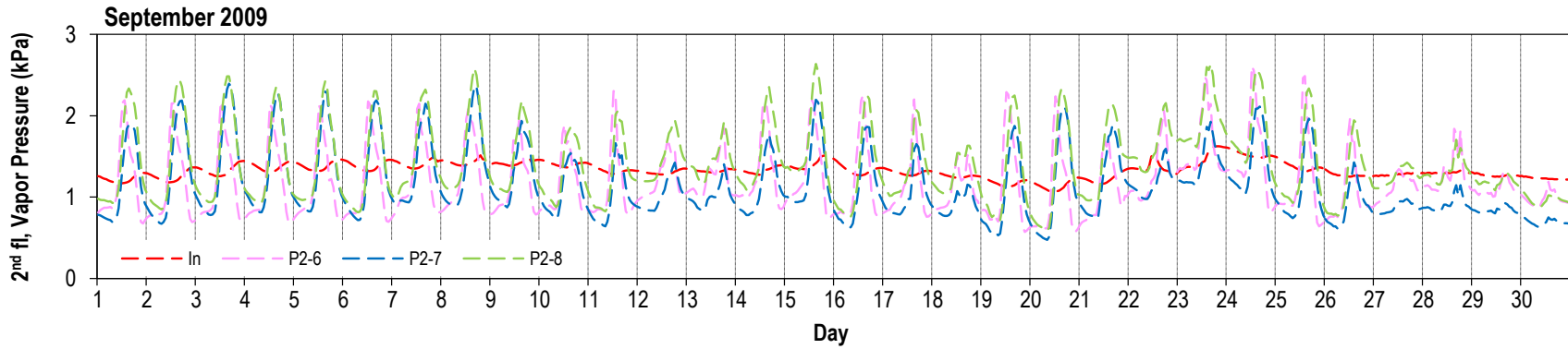
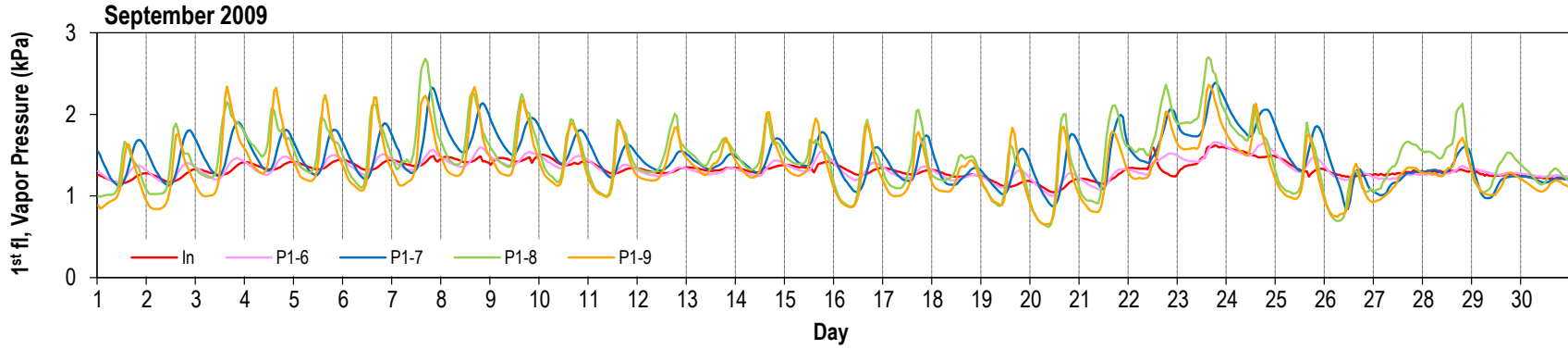

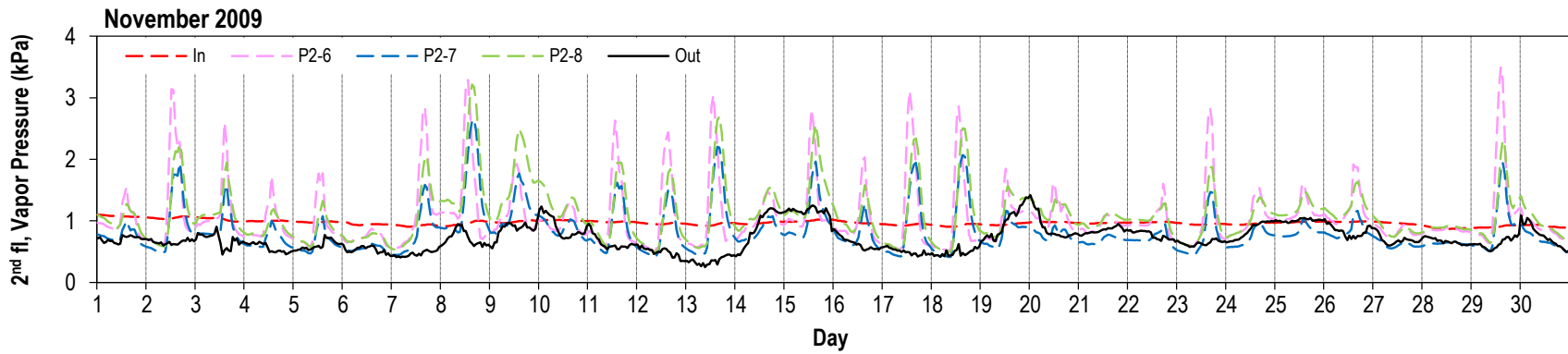
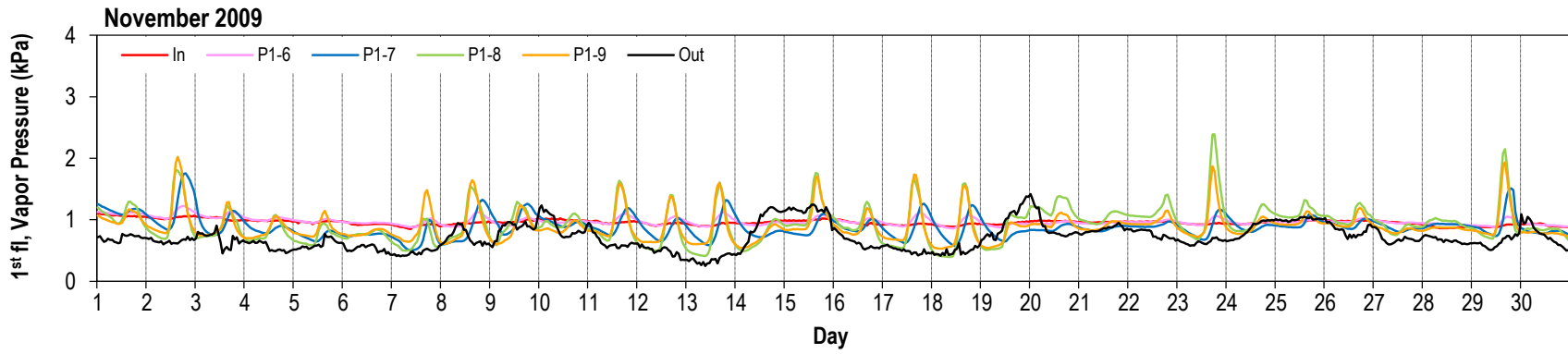
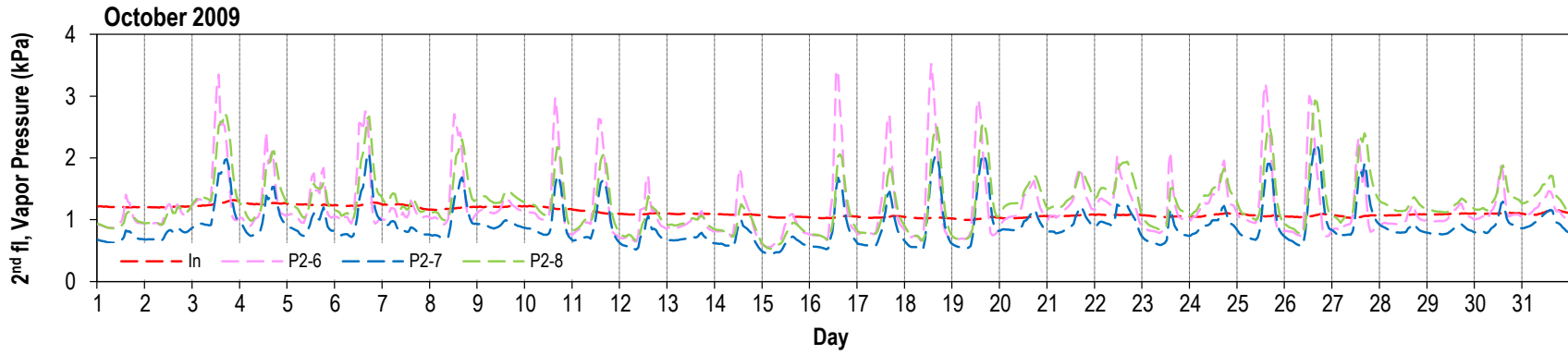

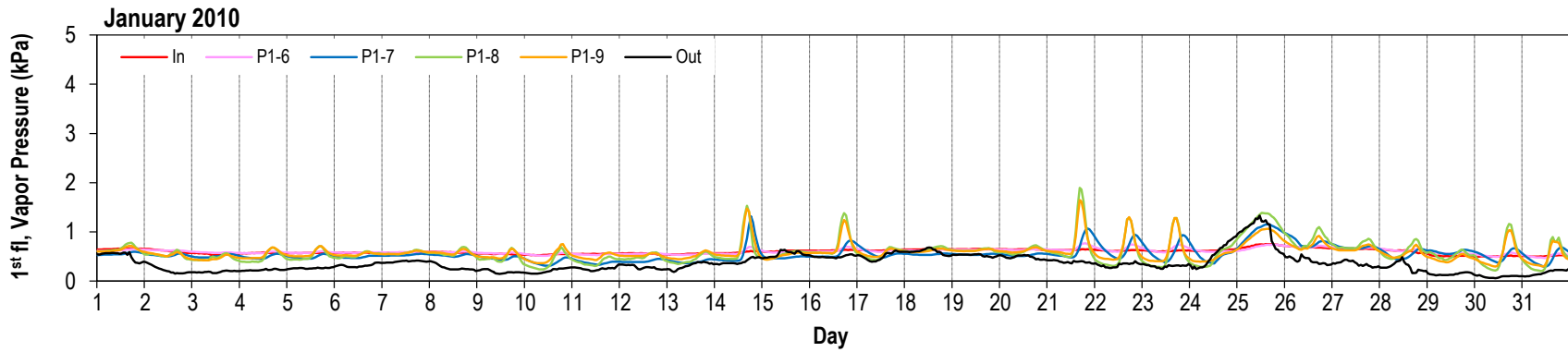
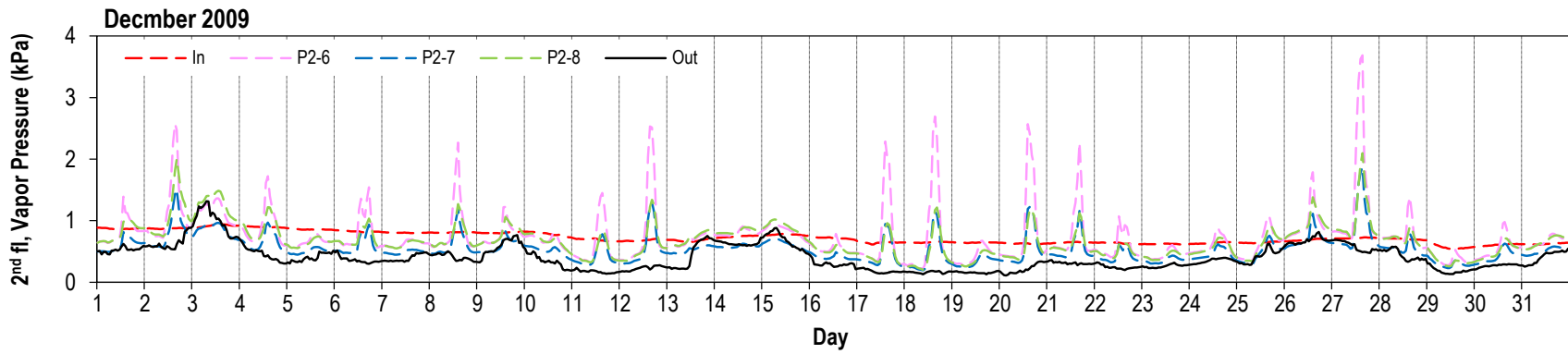
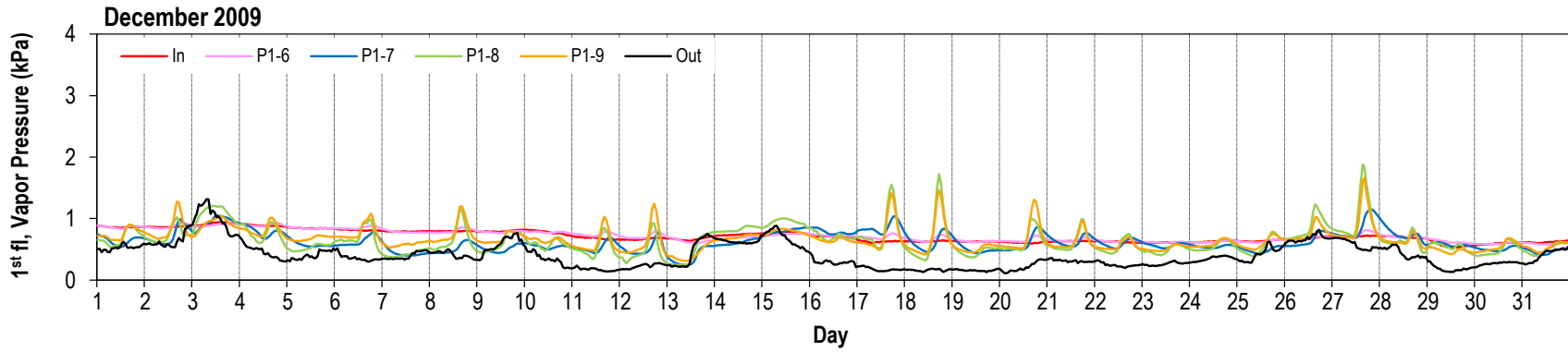

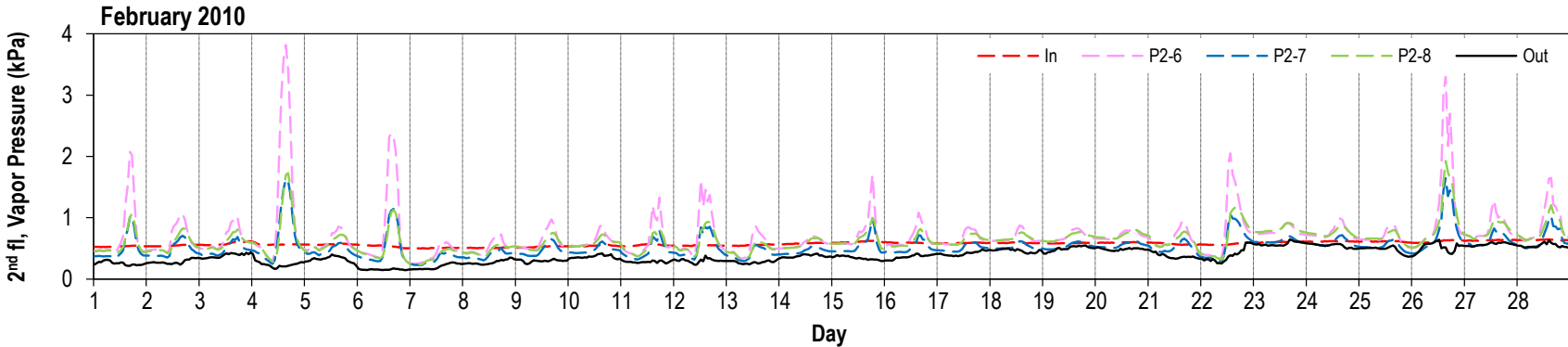
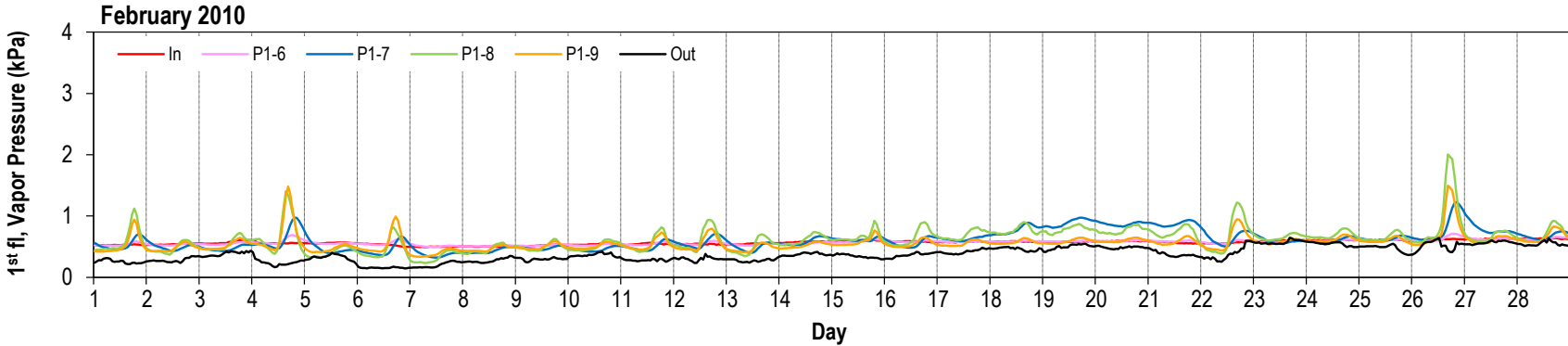
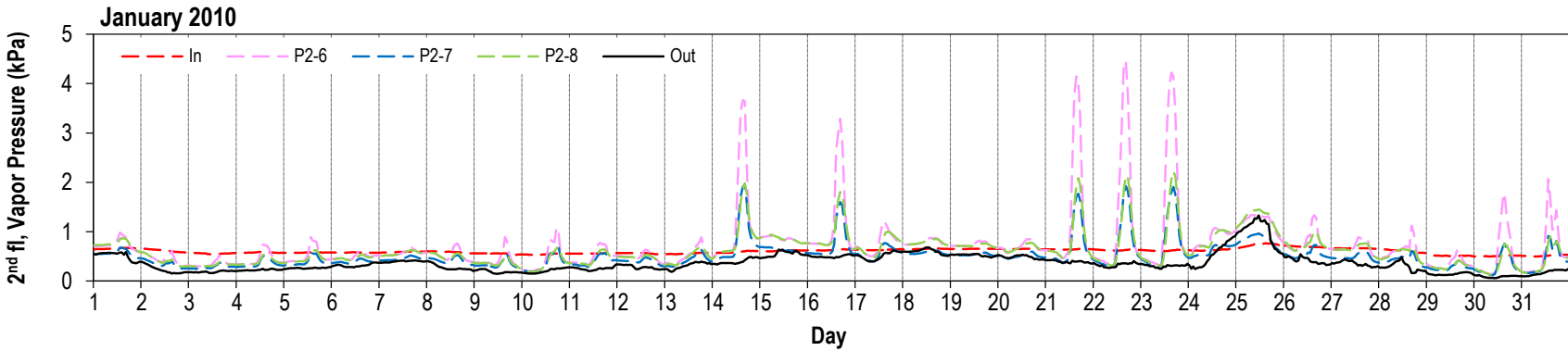

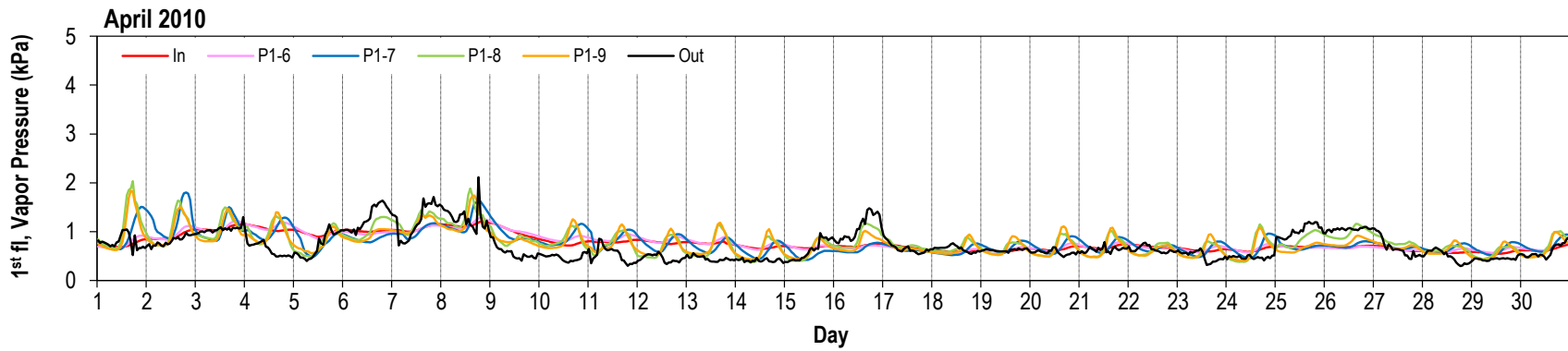
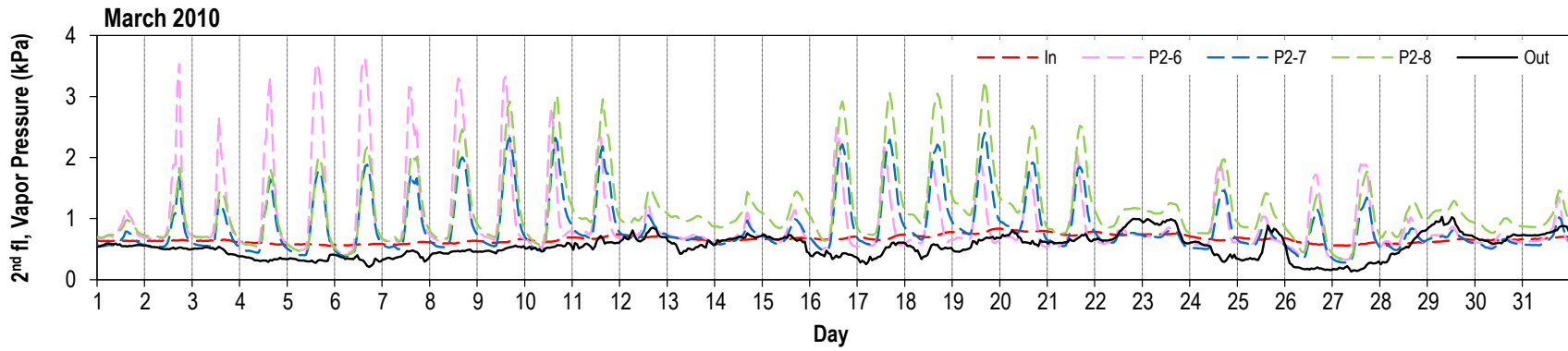
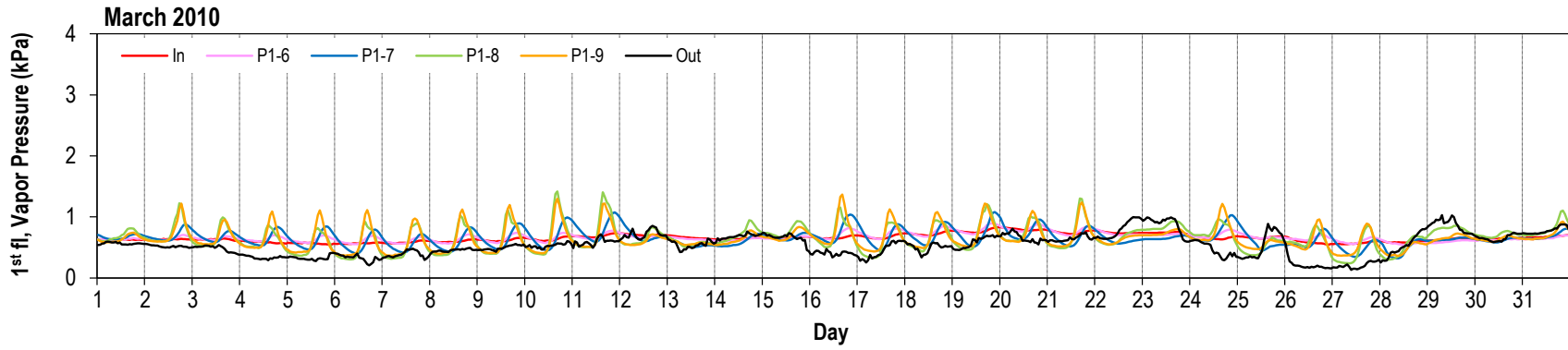

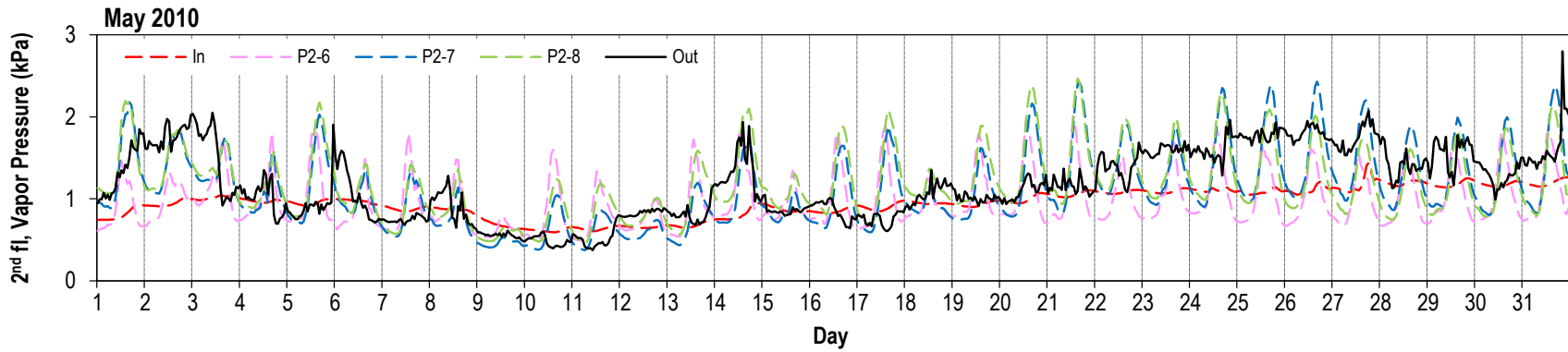
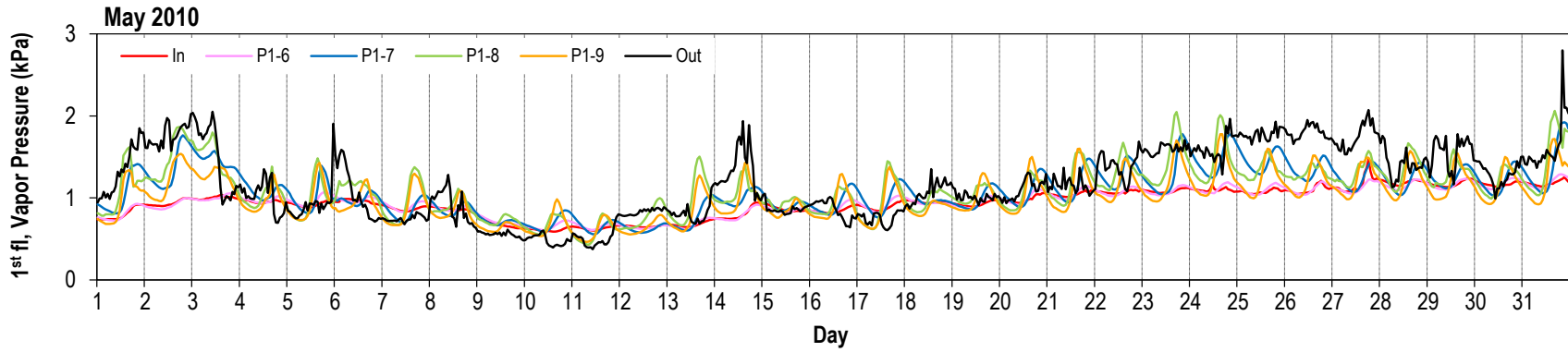
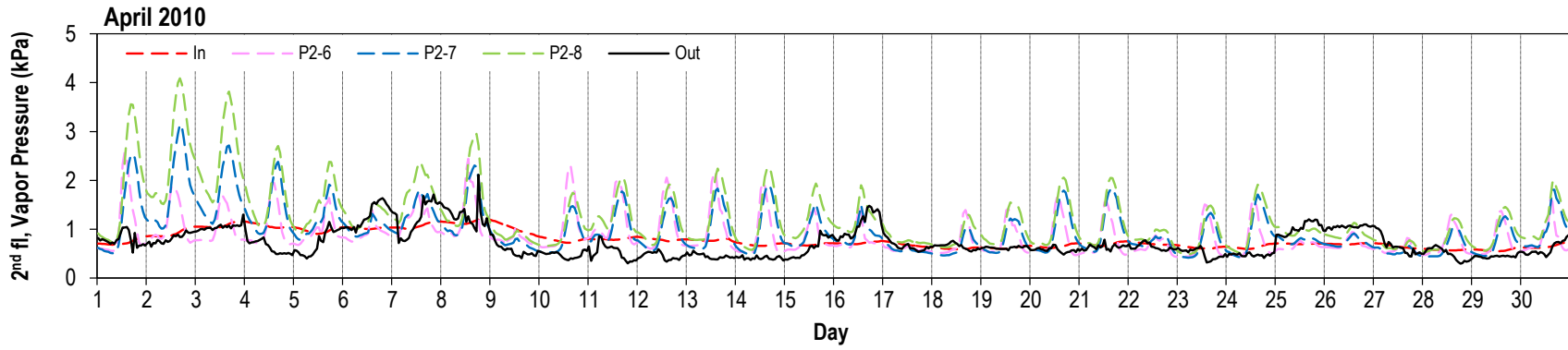

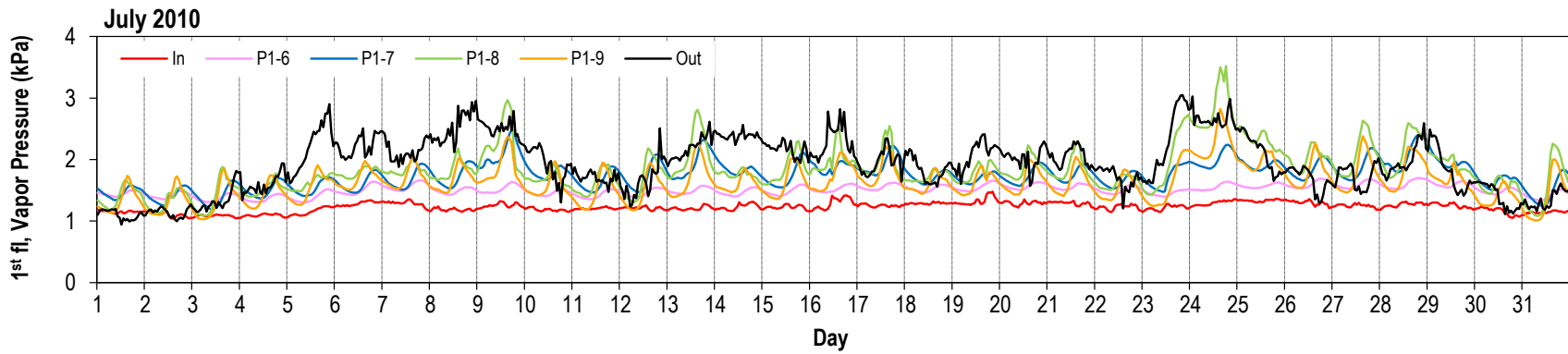
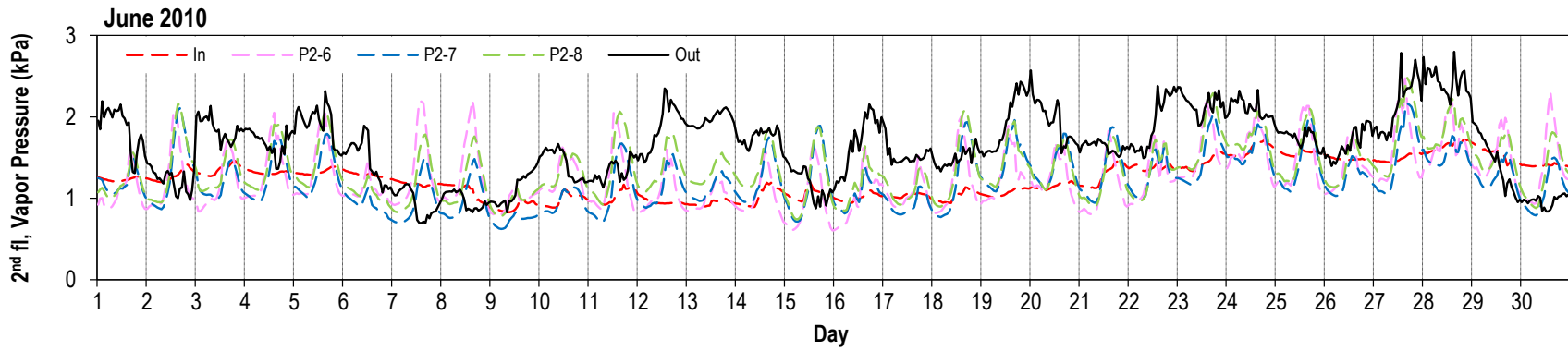
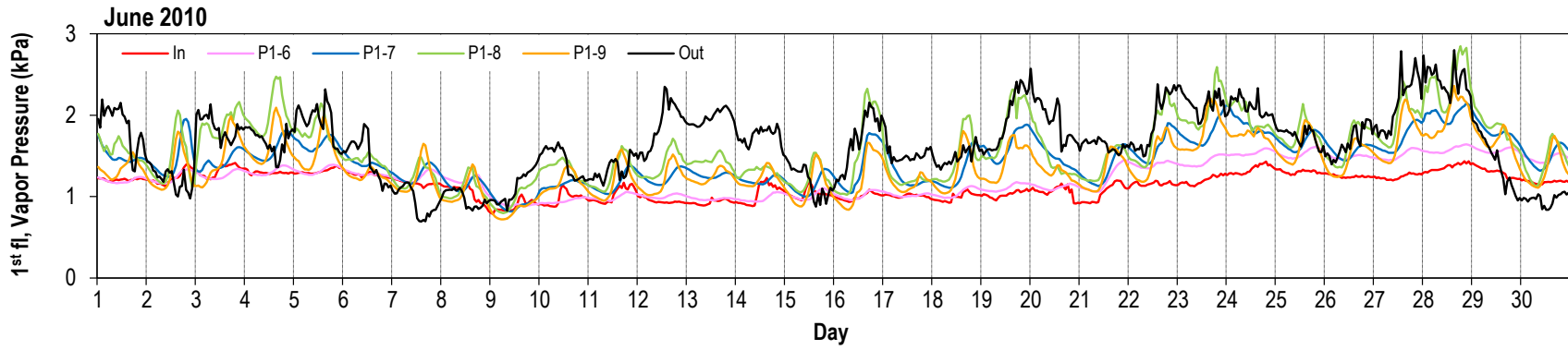

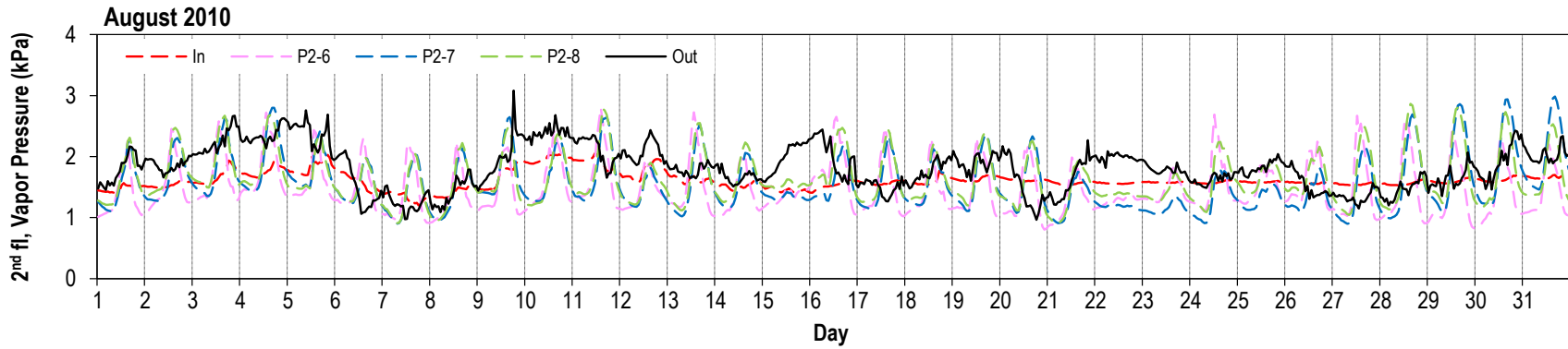
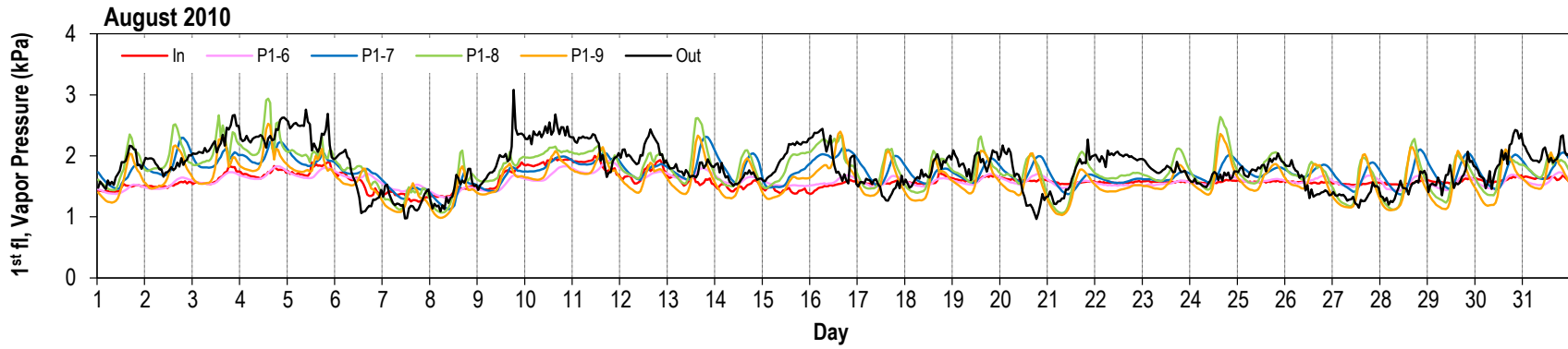
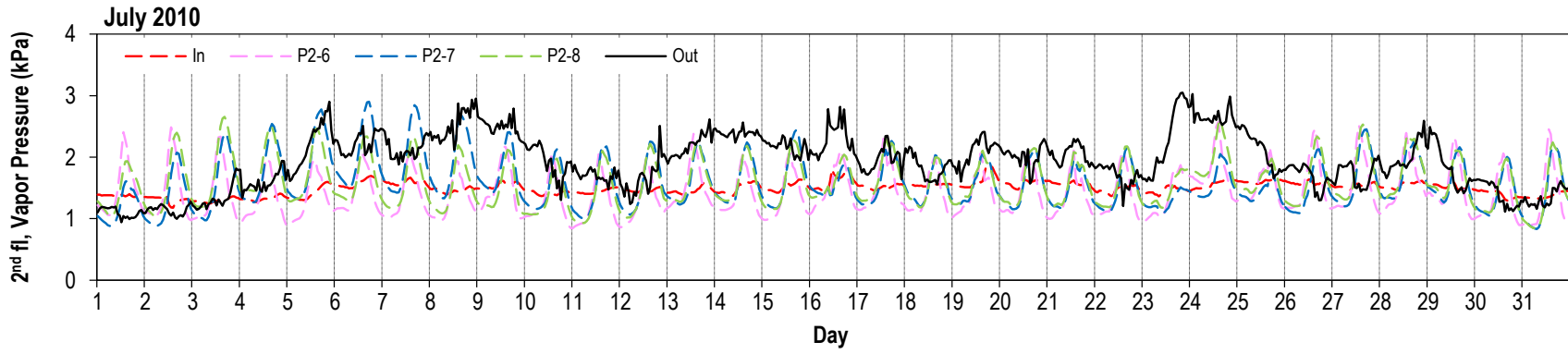

Heat flux (W/m^2) thru interior side of stud cavity. Refer to Figures 25 thru 28 for sensor location.

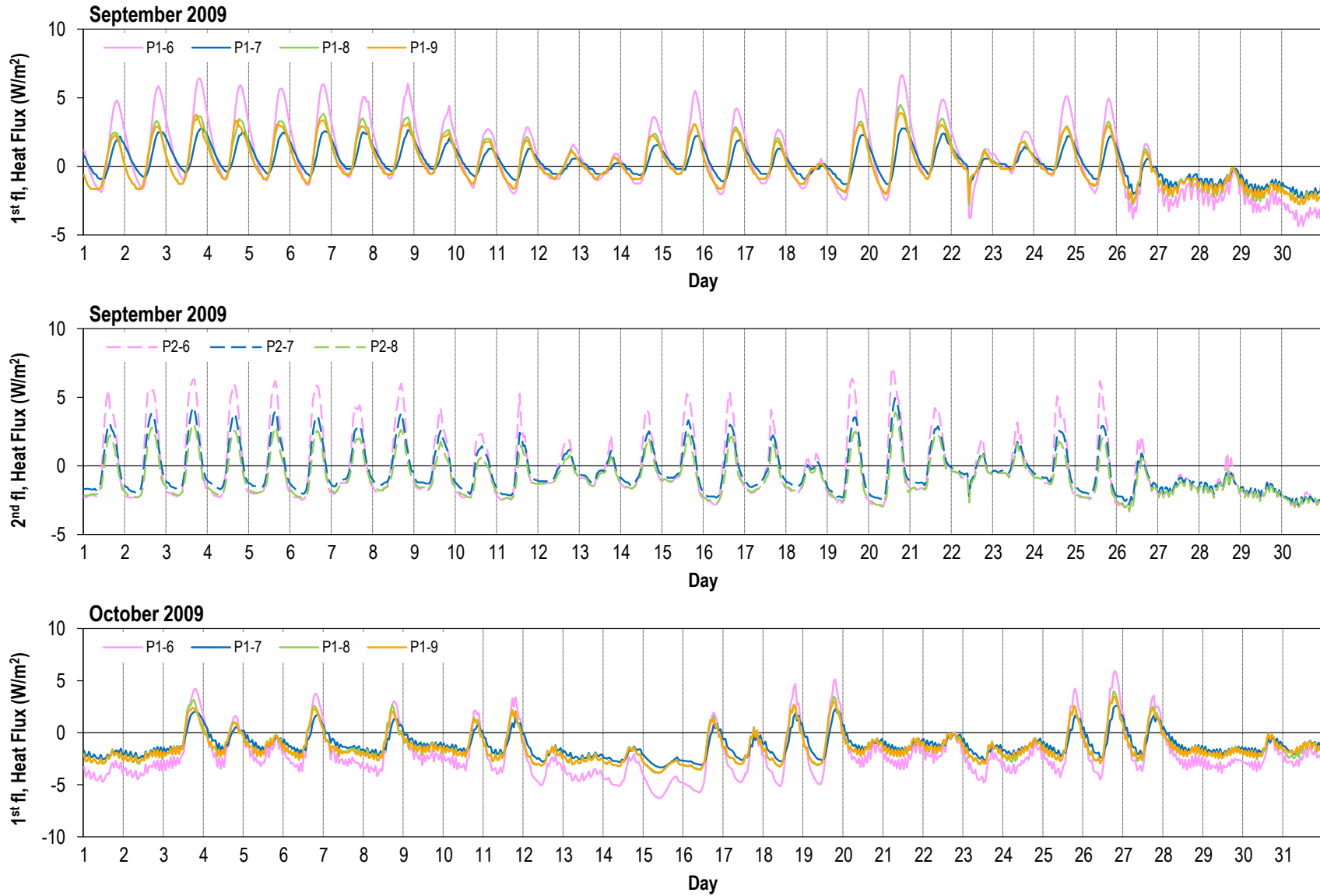

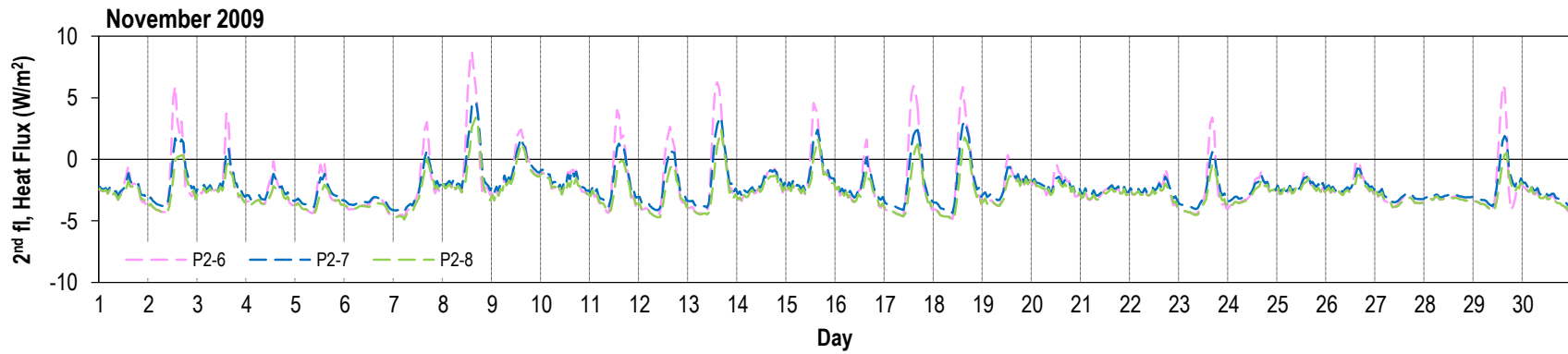
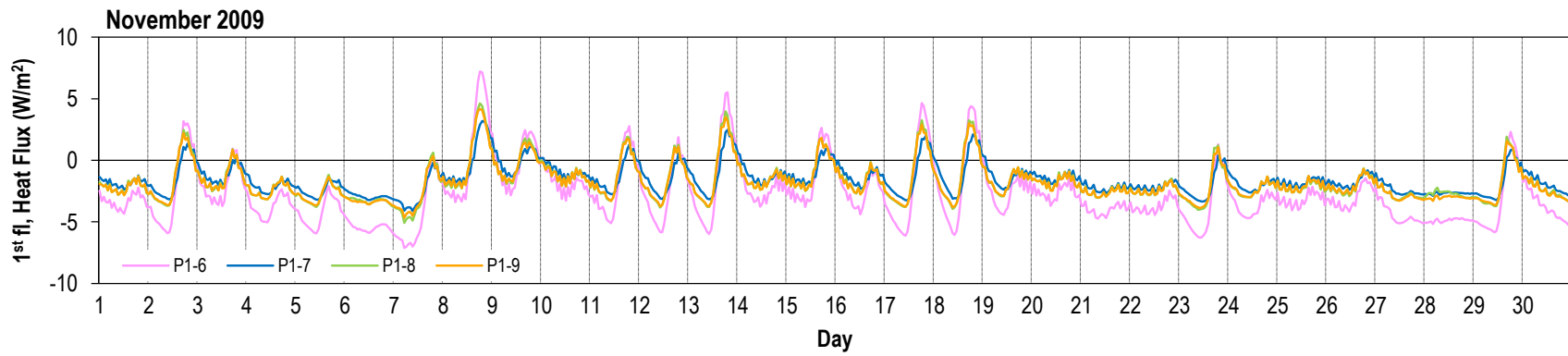
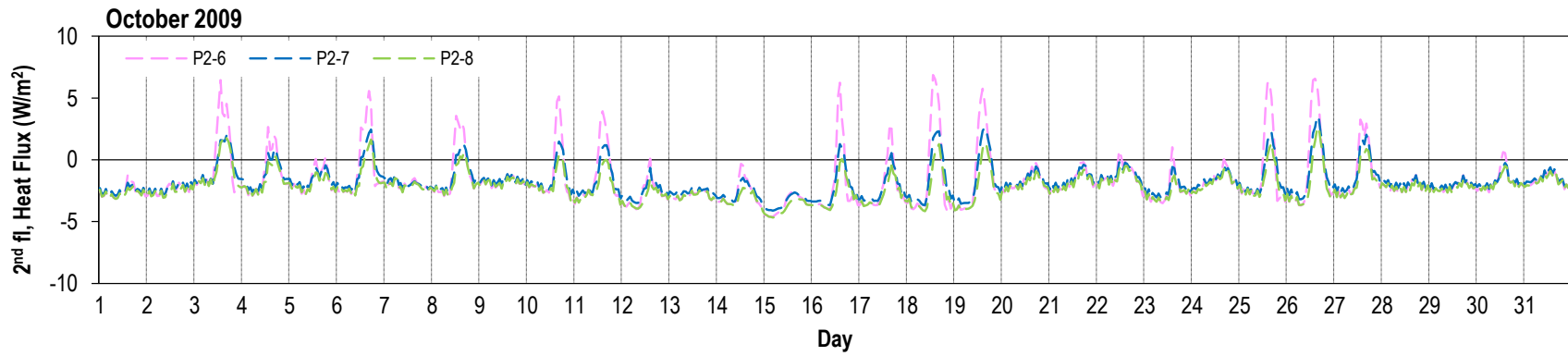

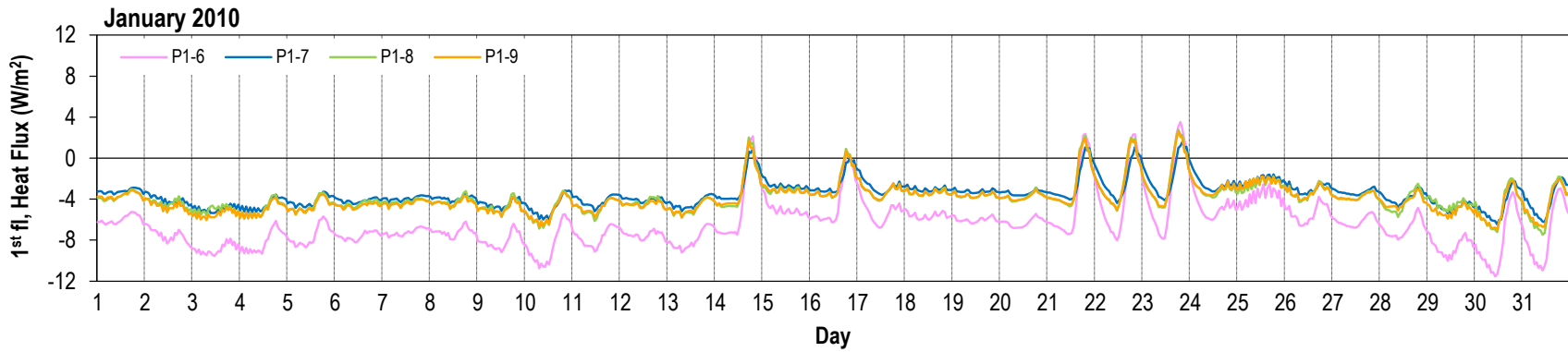
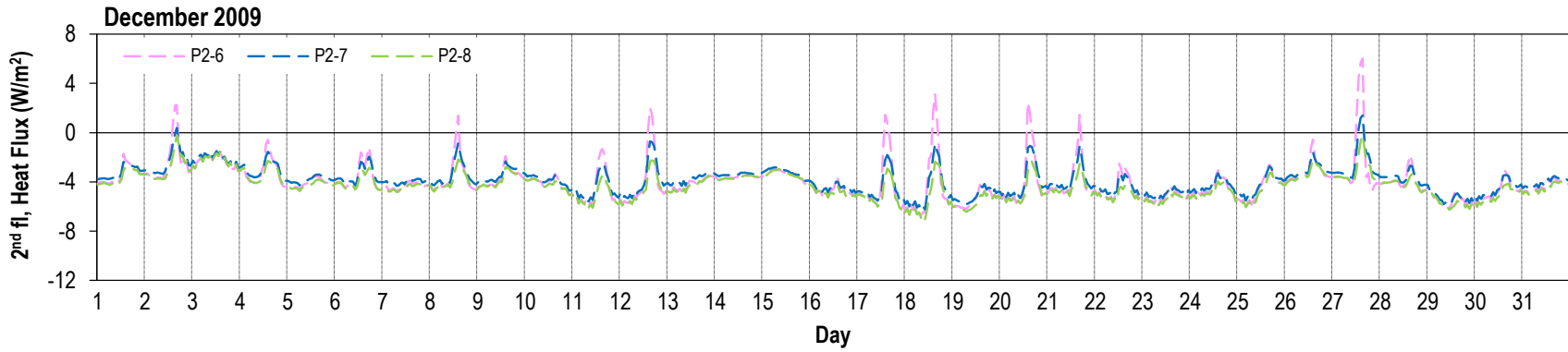
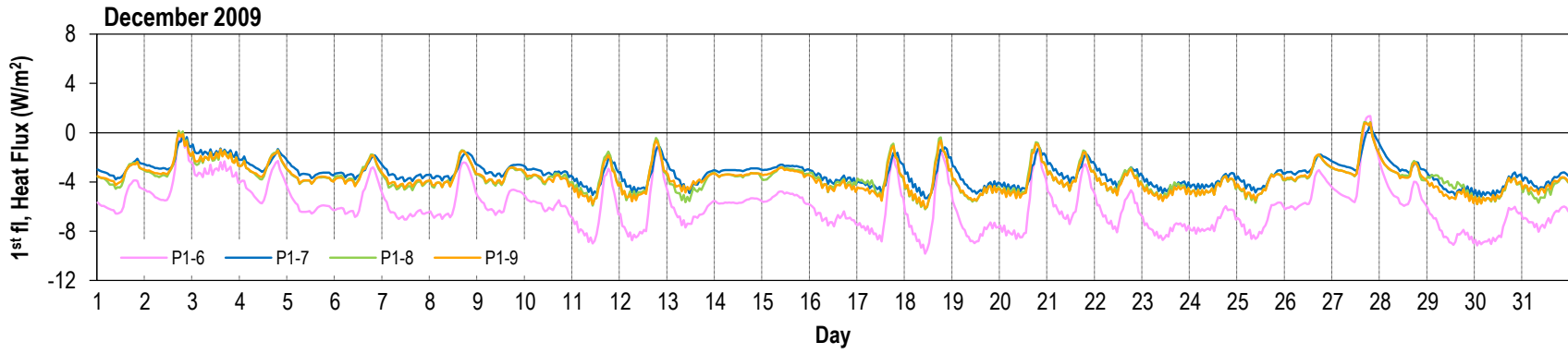

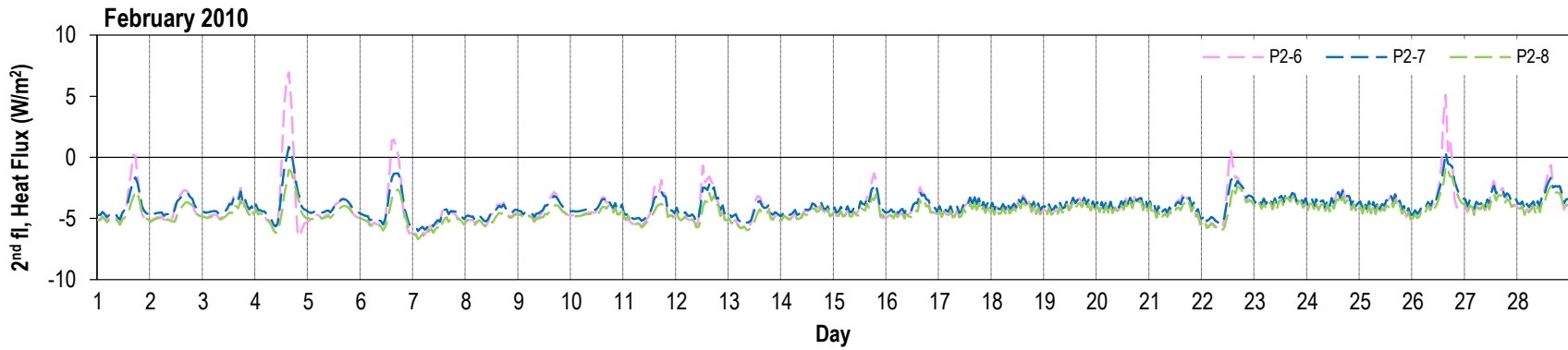
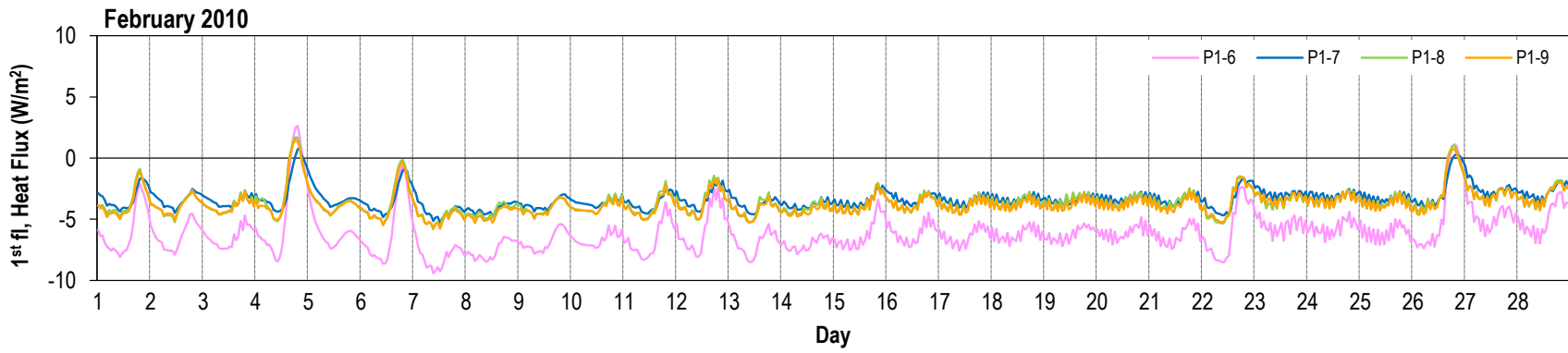
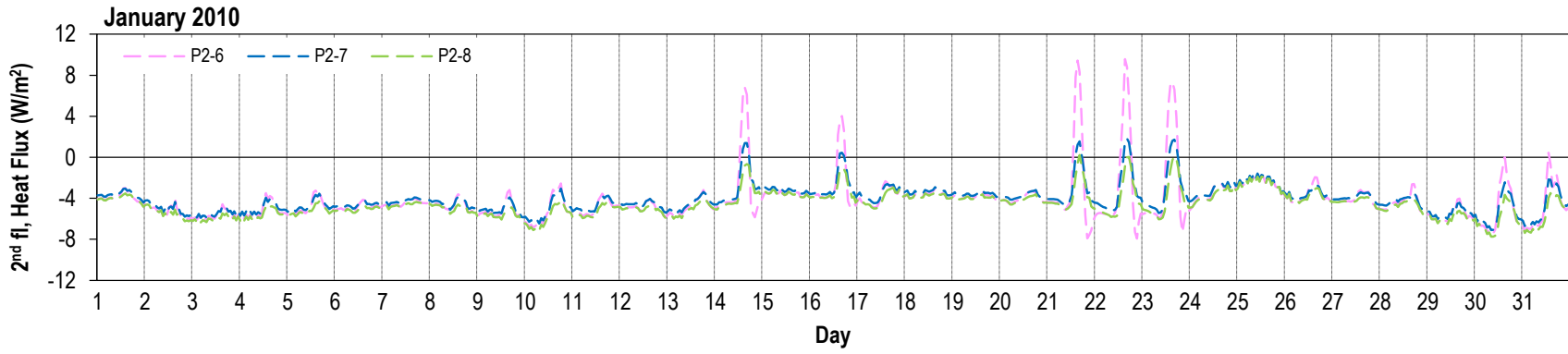

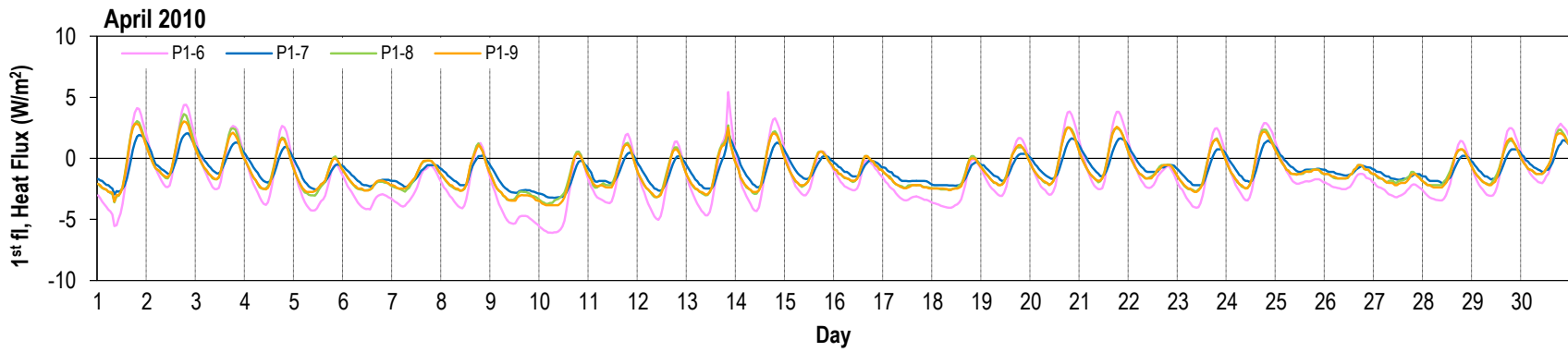
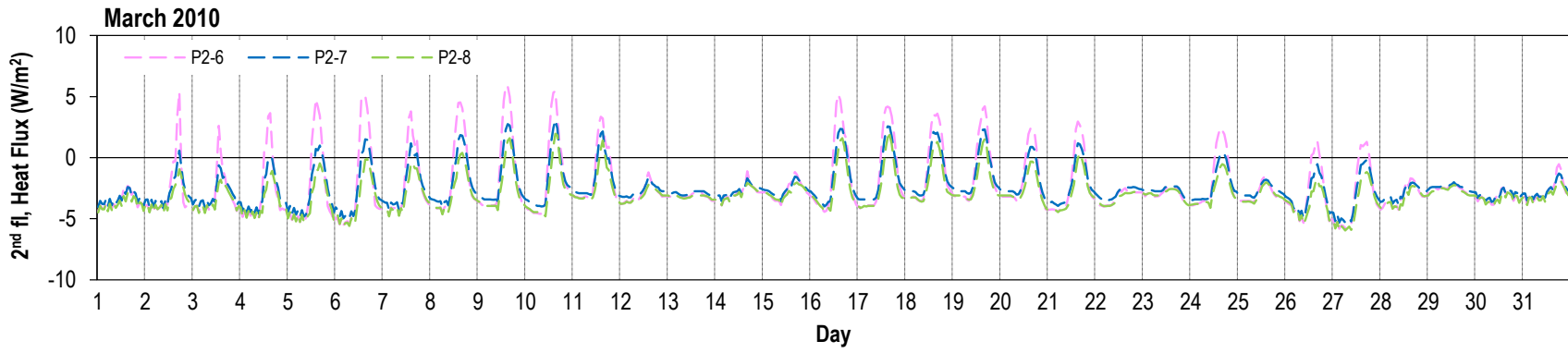
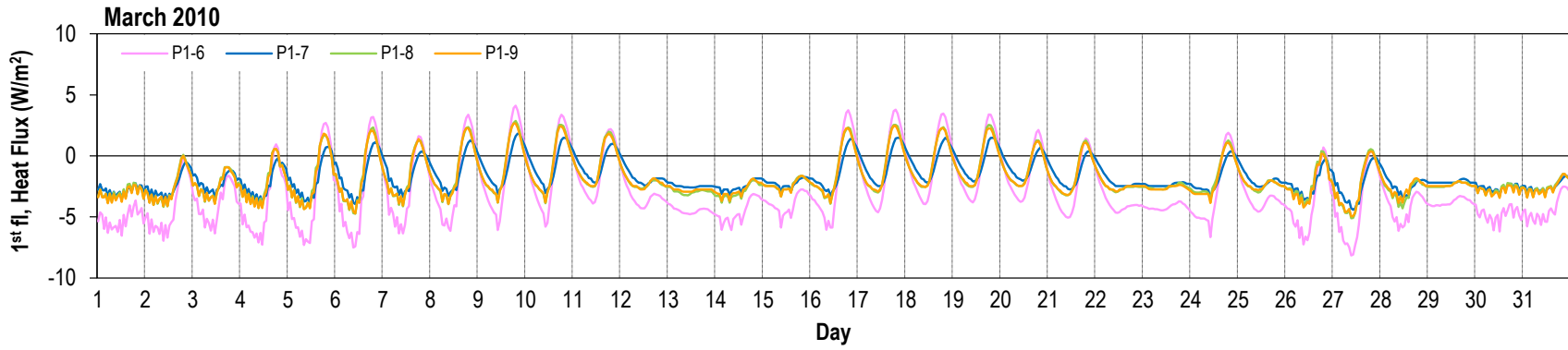

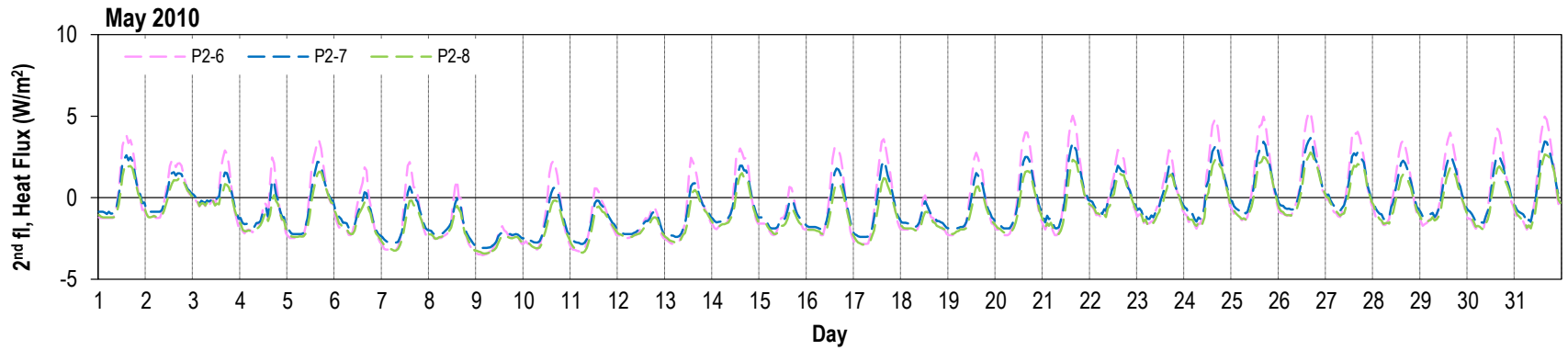
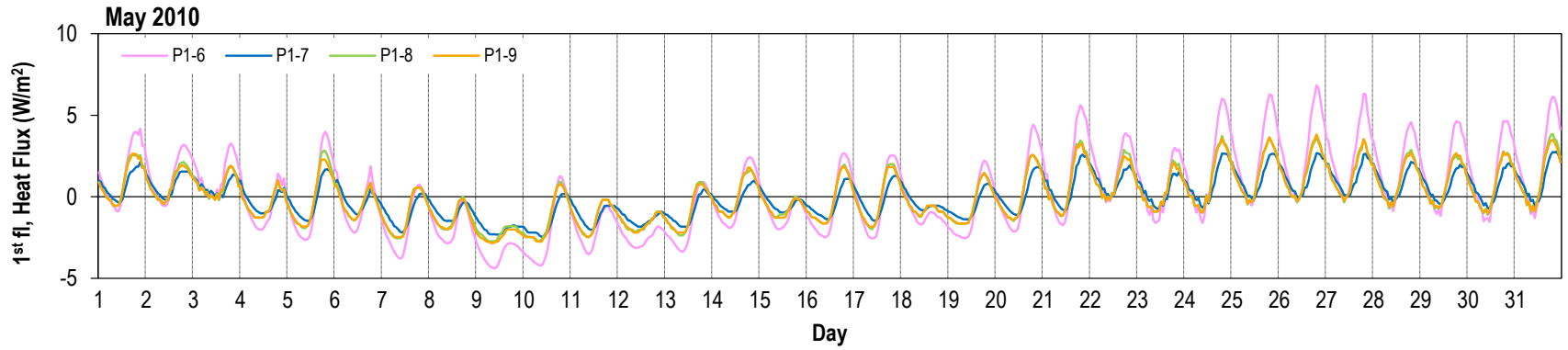
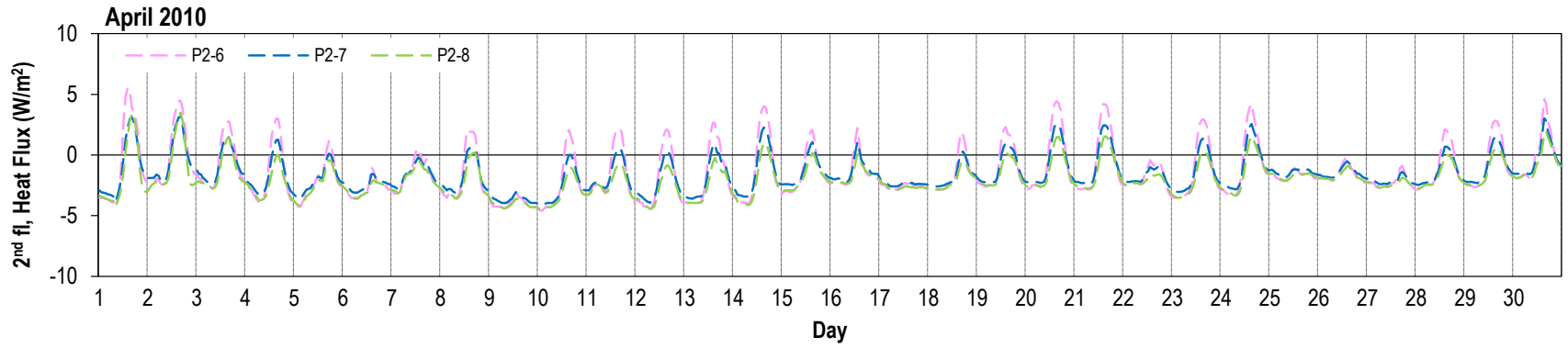

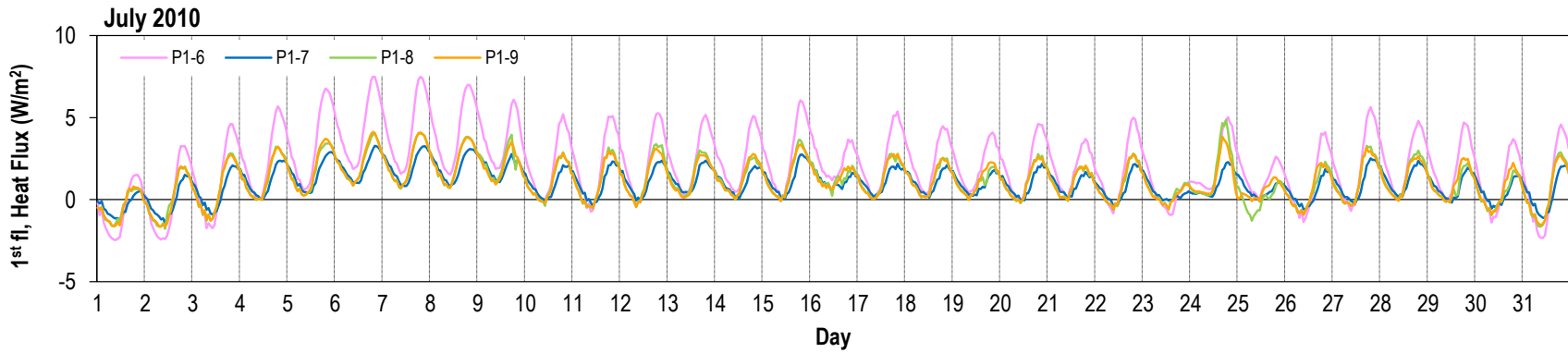
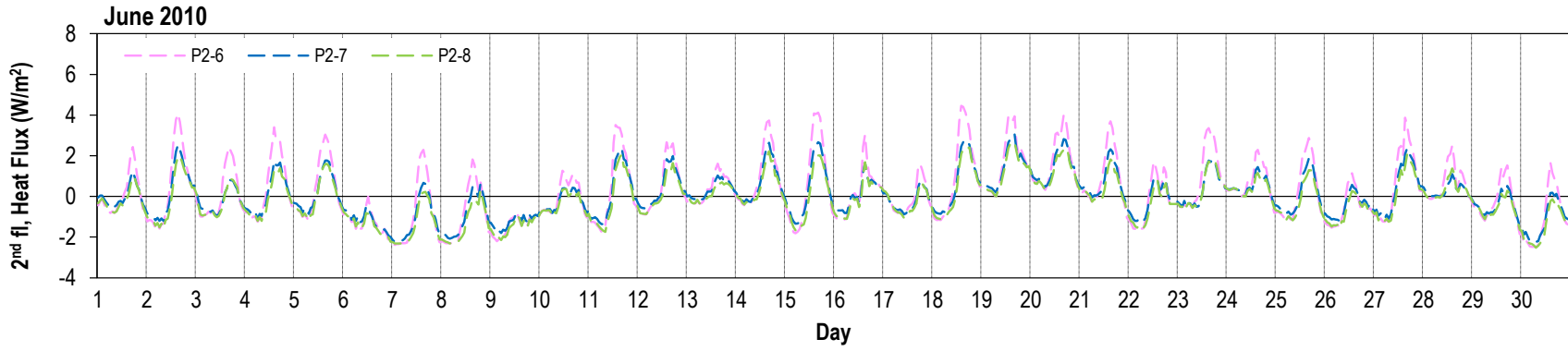
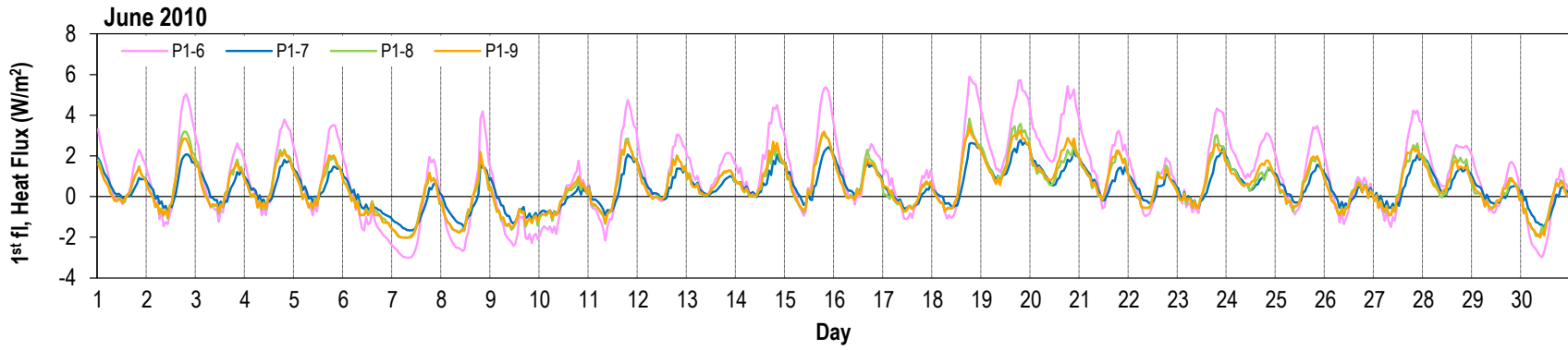

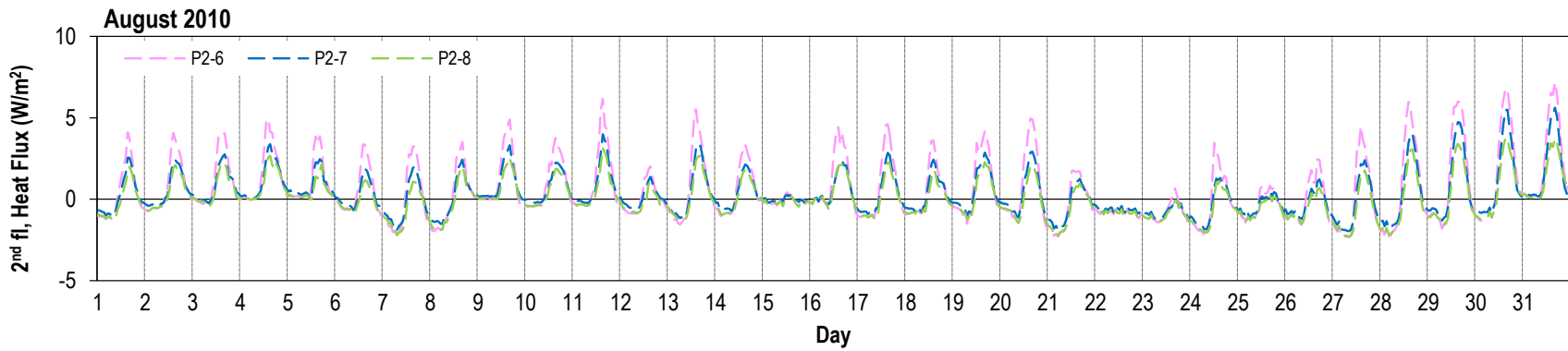
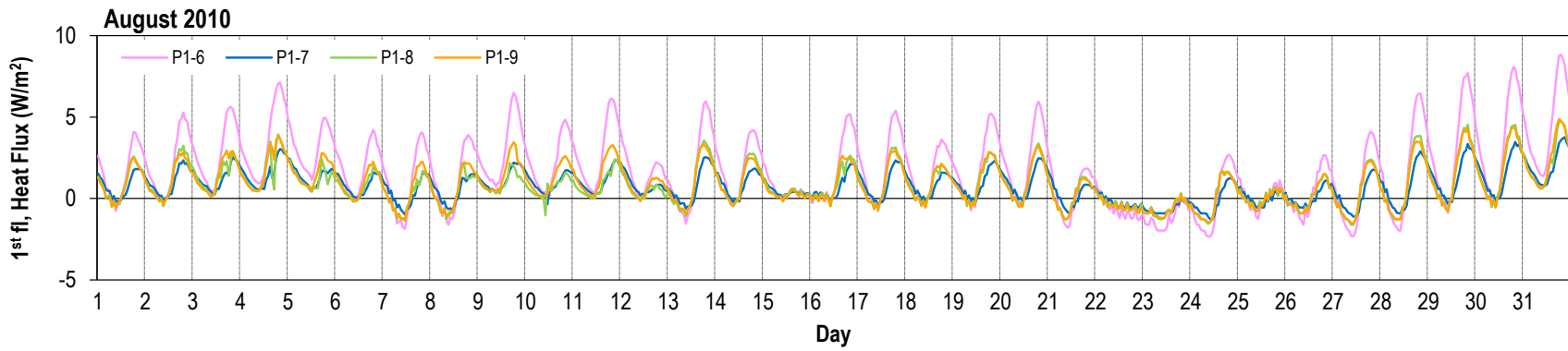
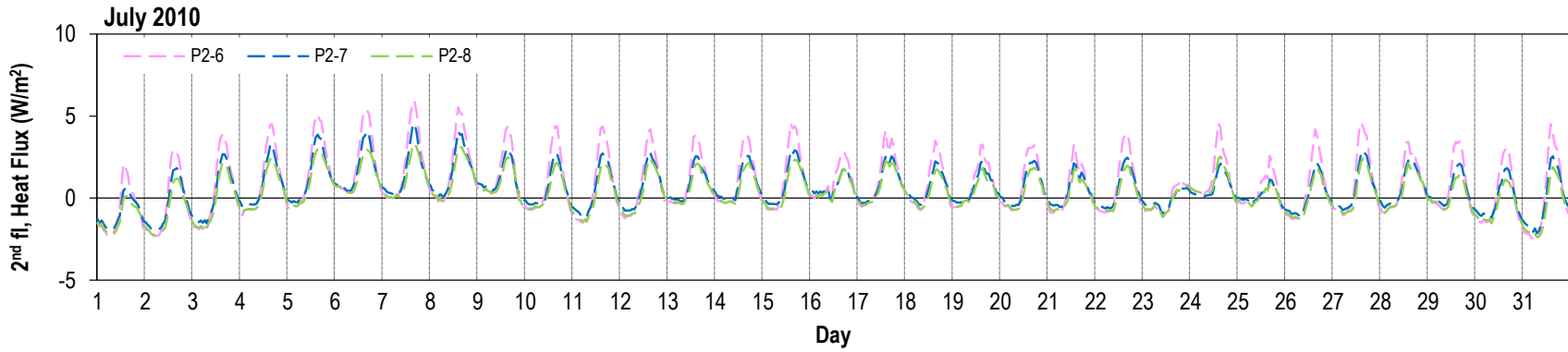

Cooling loads (Wh/m²). Refer to Figures 25 thru 28 for sensor location.

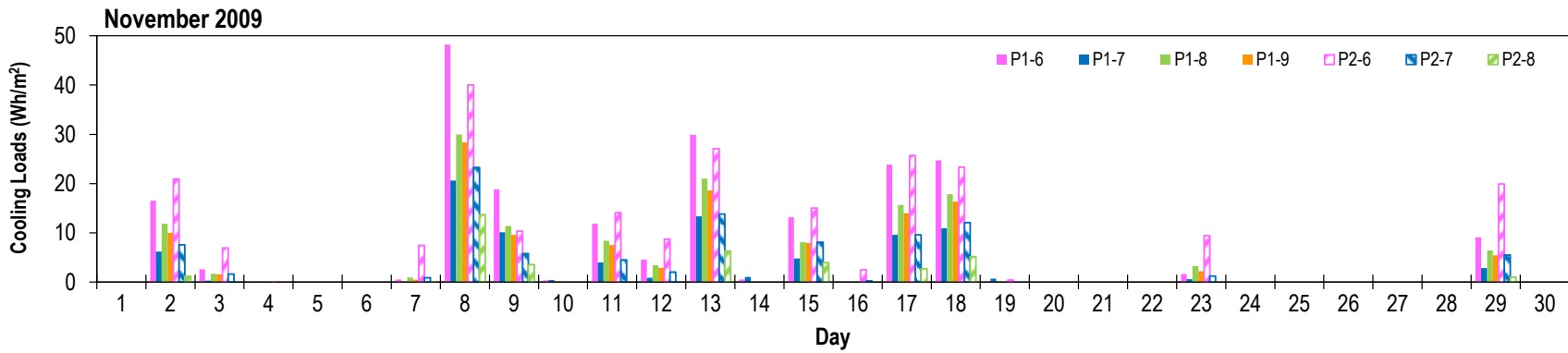
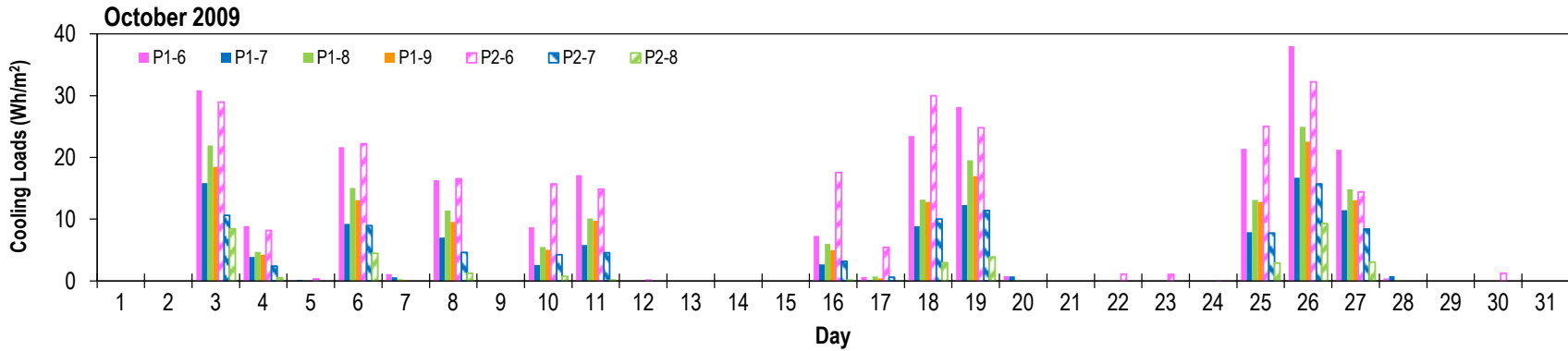
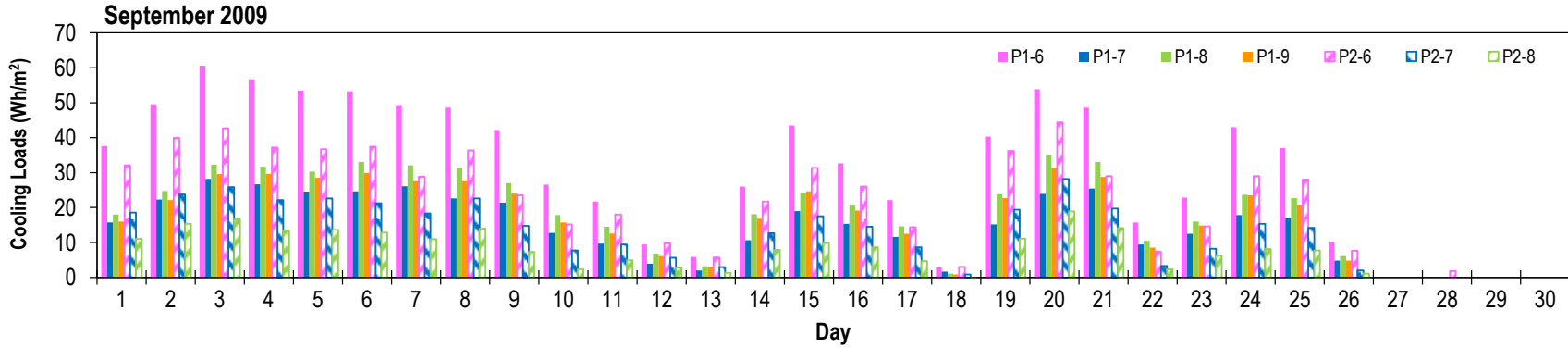

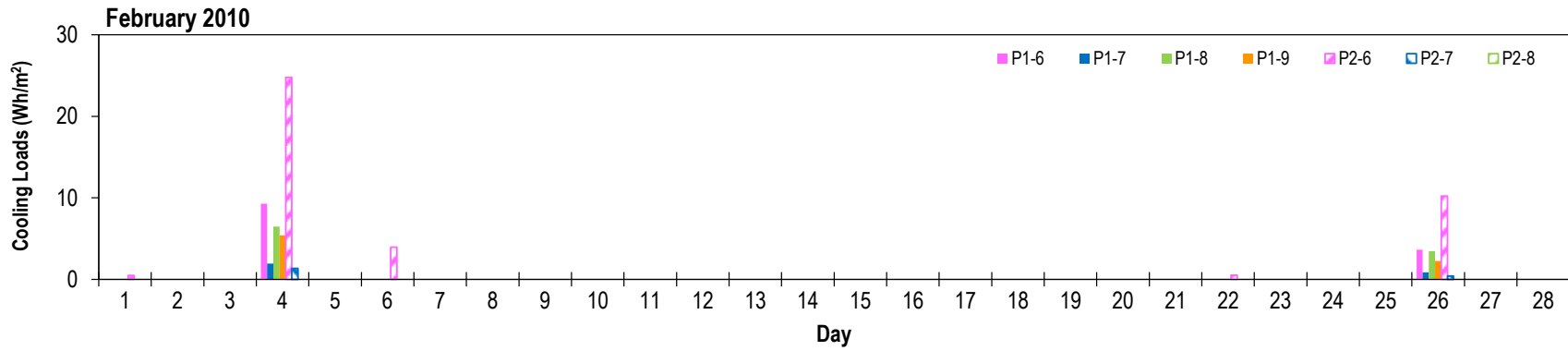
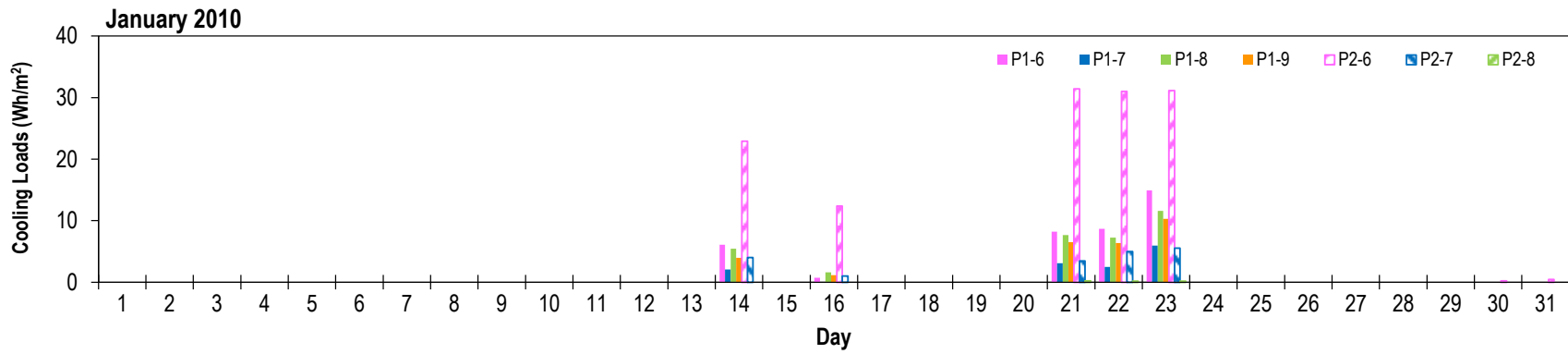
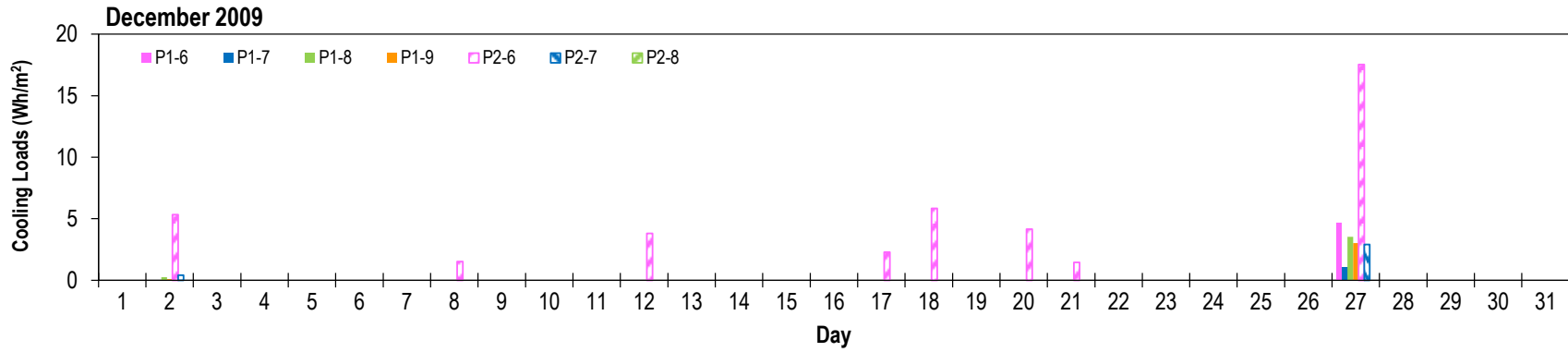

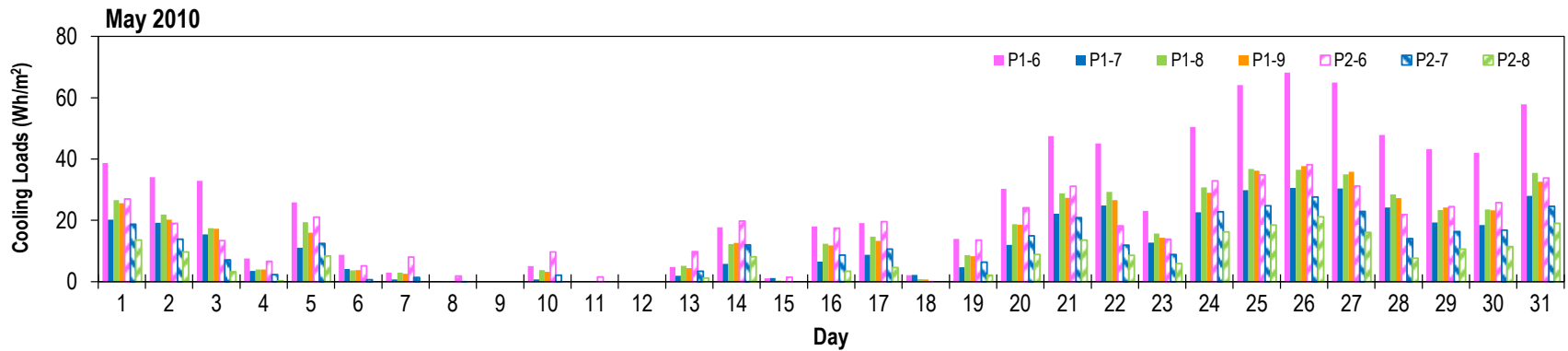
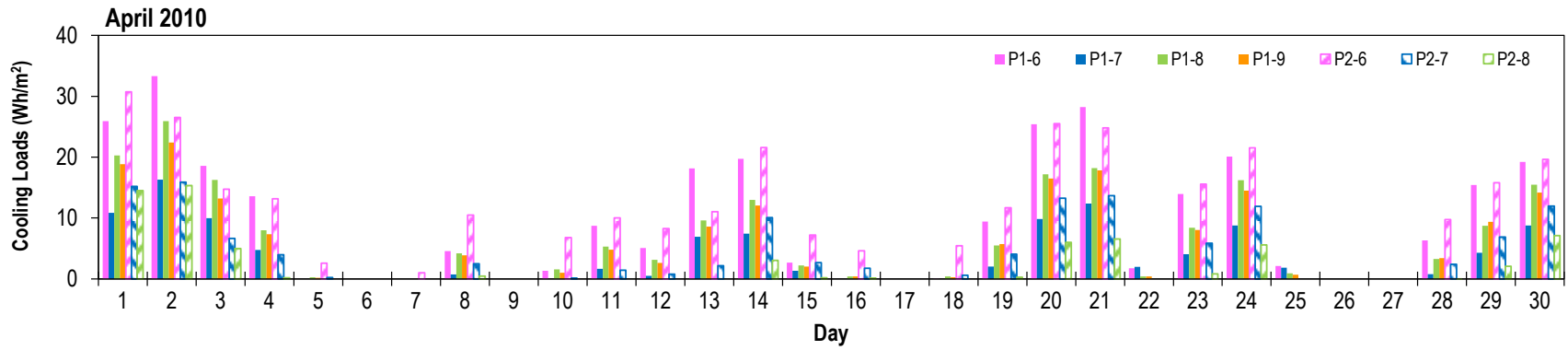
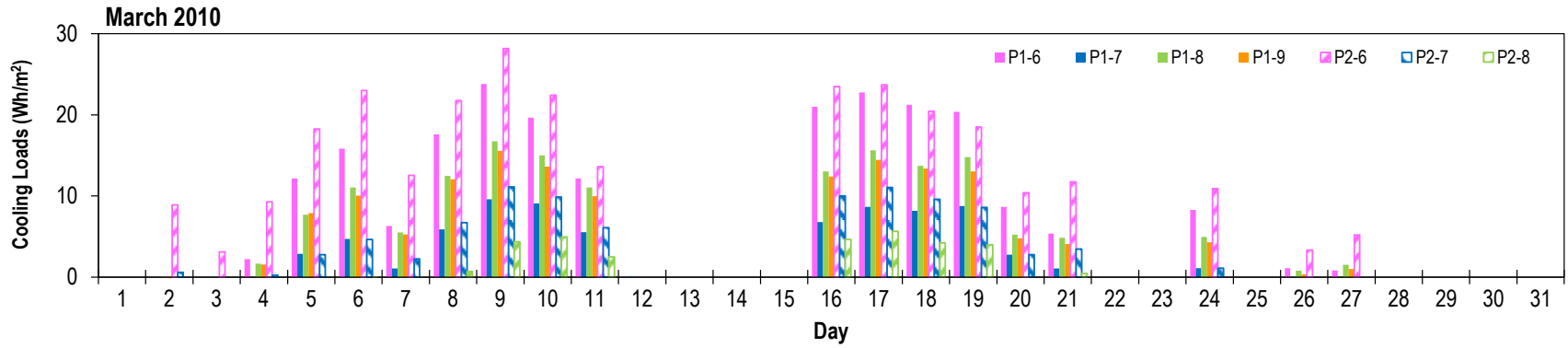

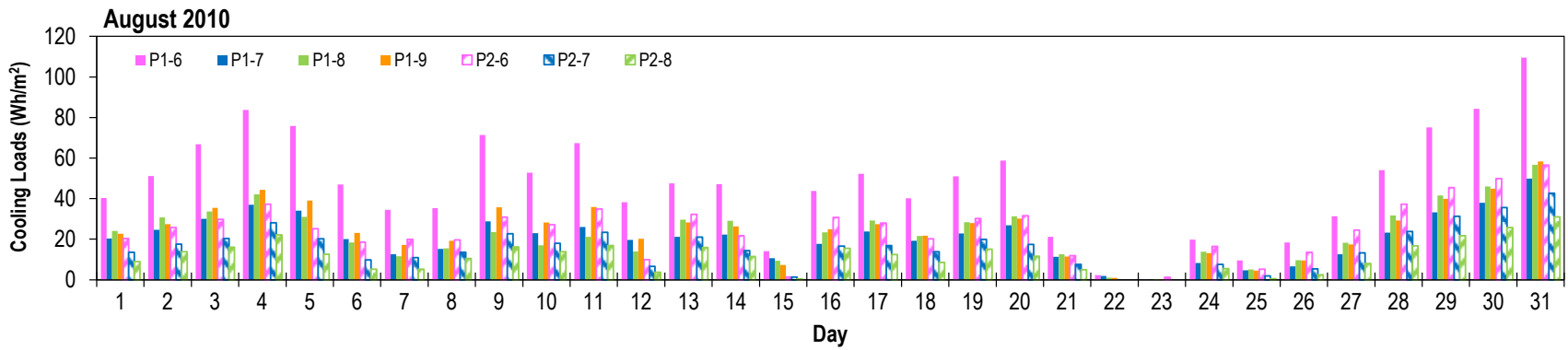
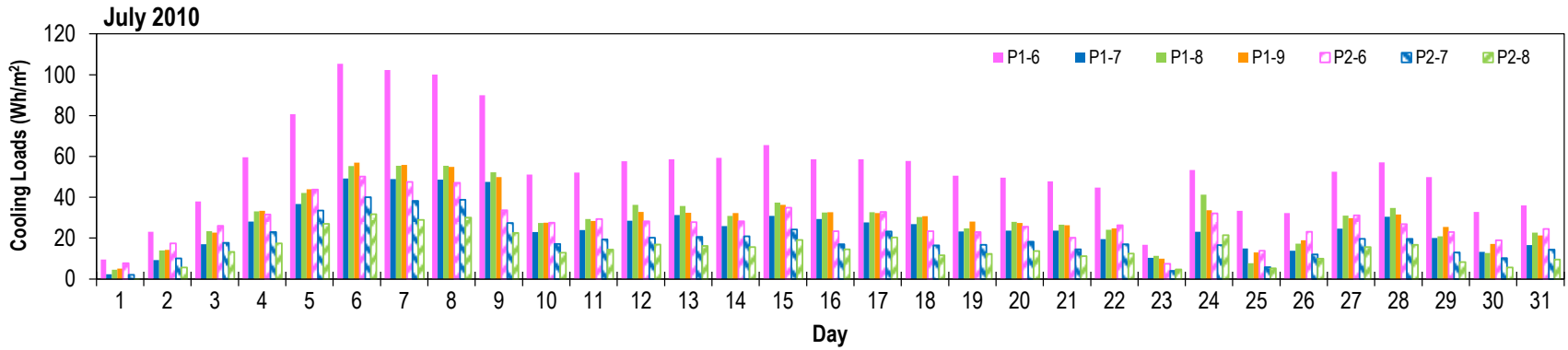
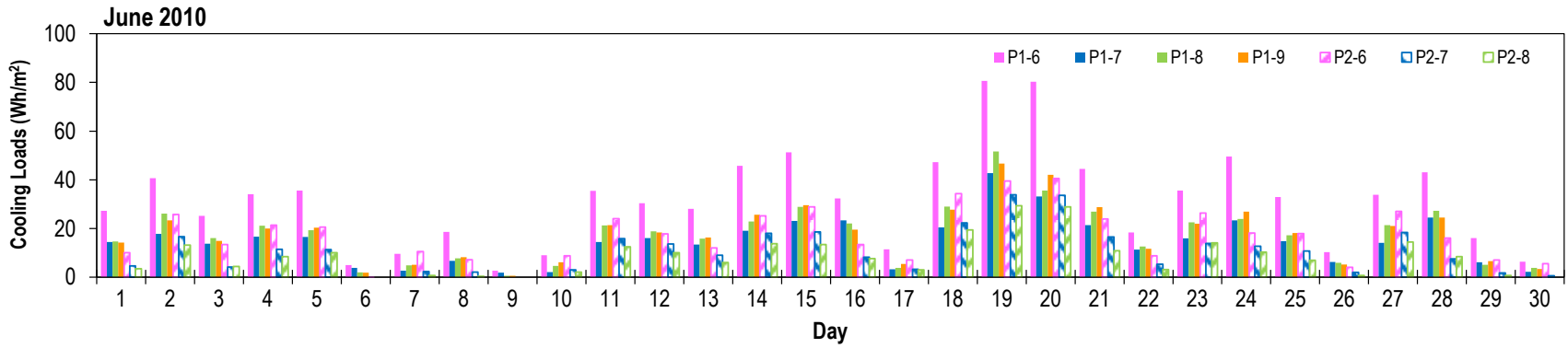

Heating loads (Wh/m²). Refer to Figures 25 thru 28 for sensor location.

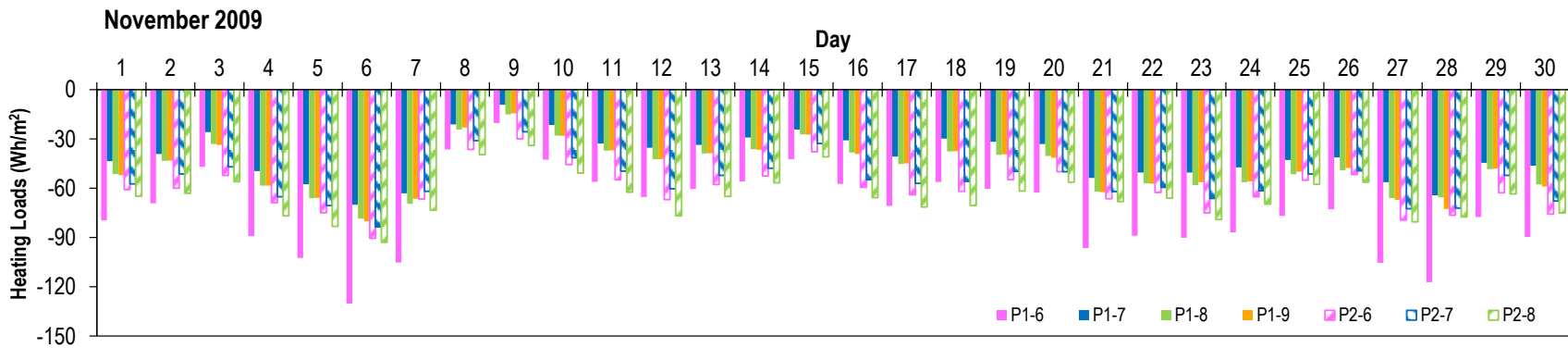
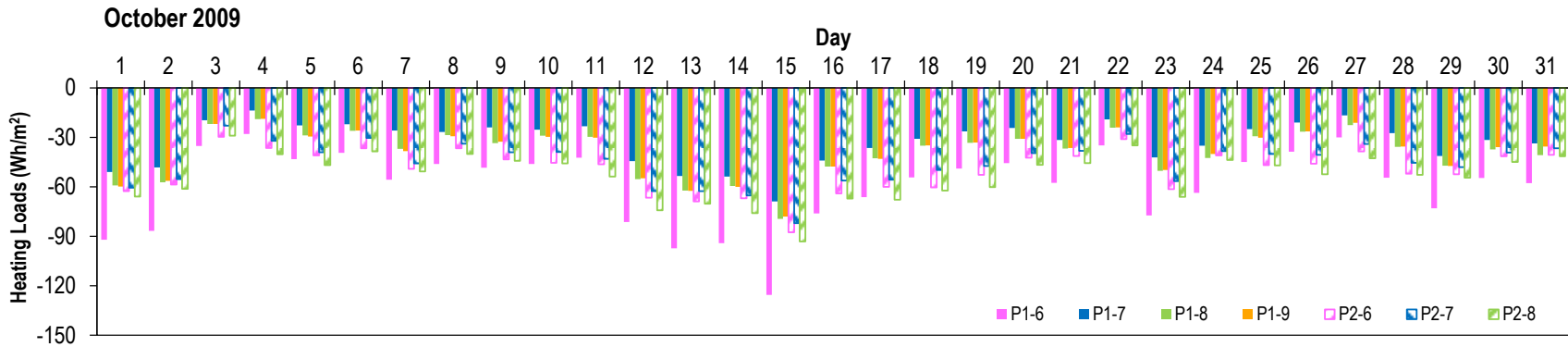
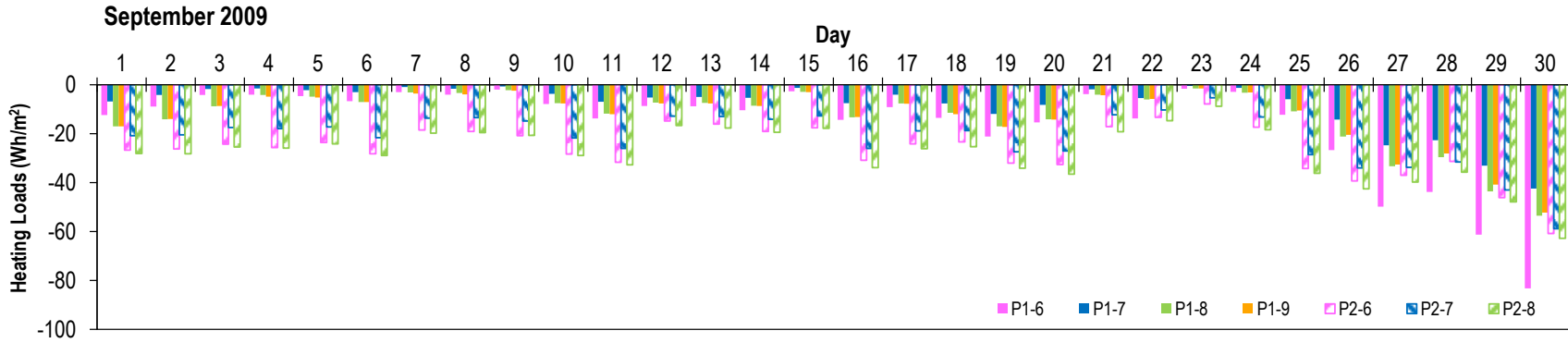

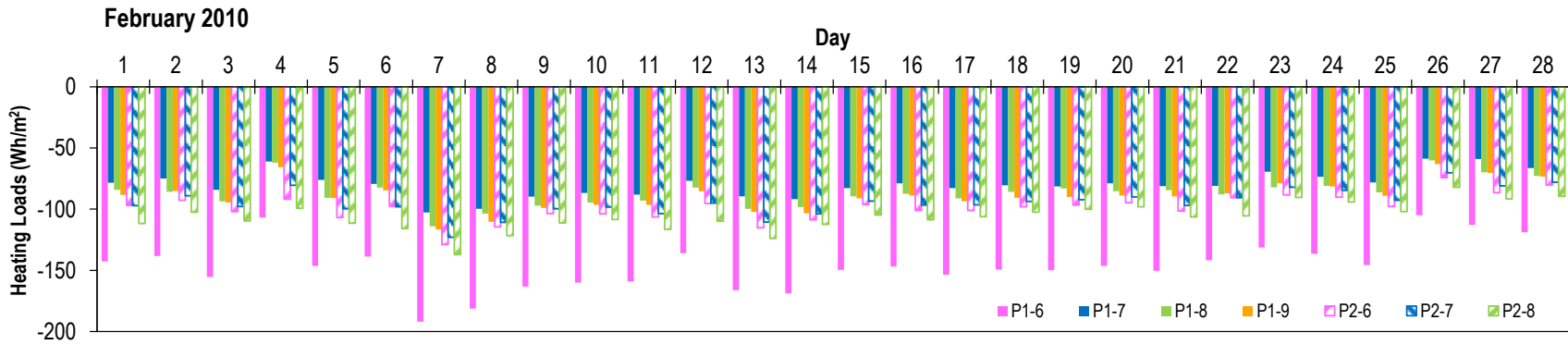
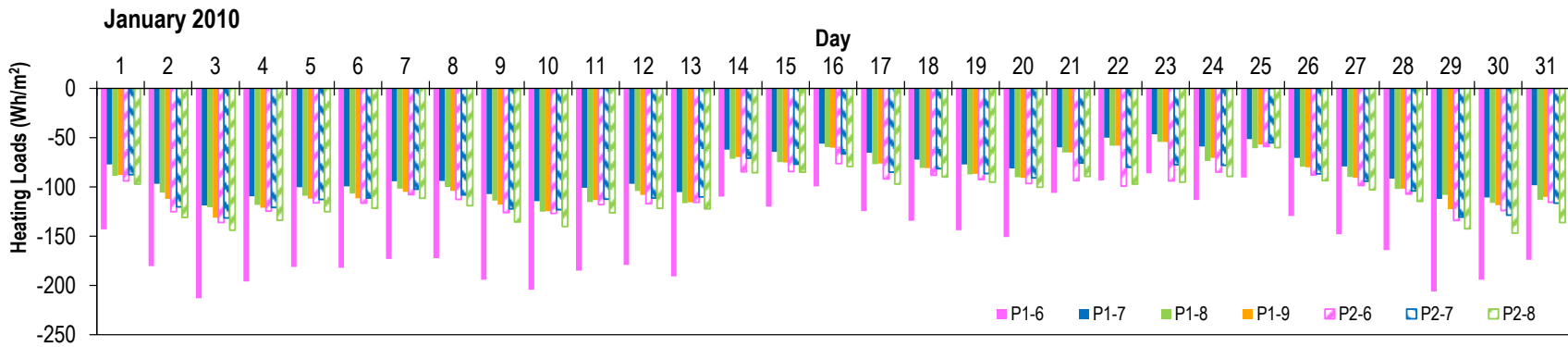
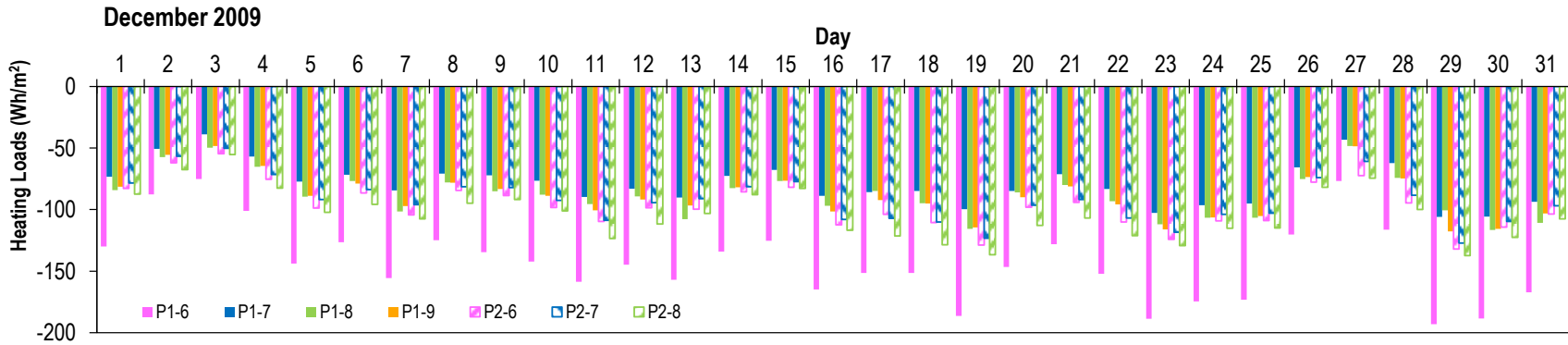

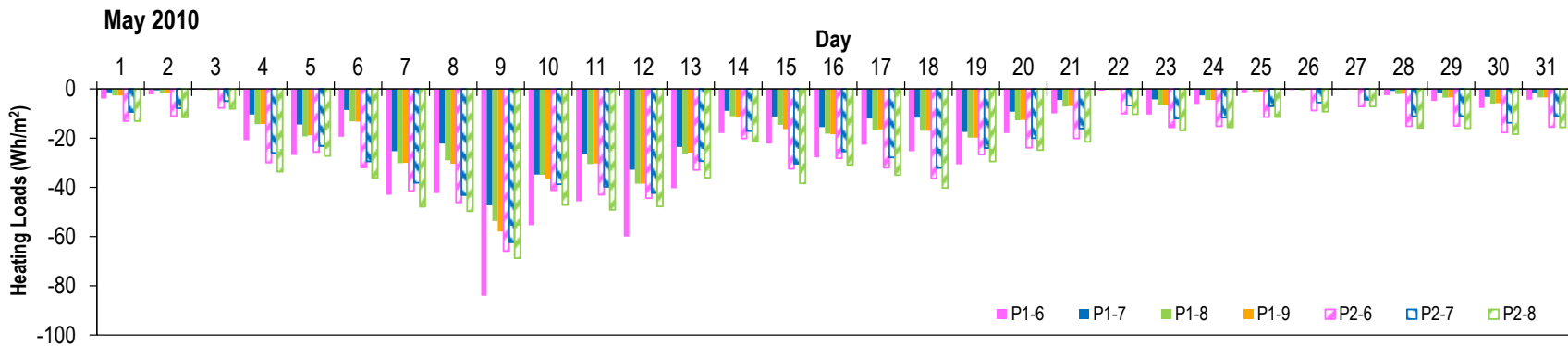
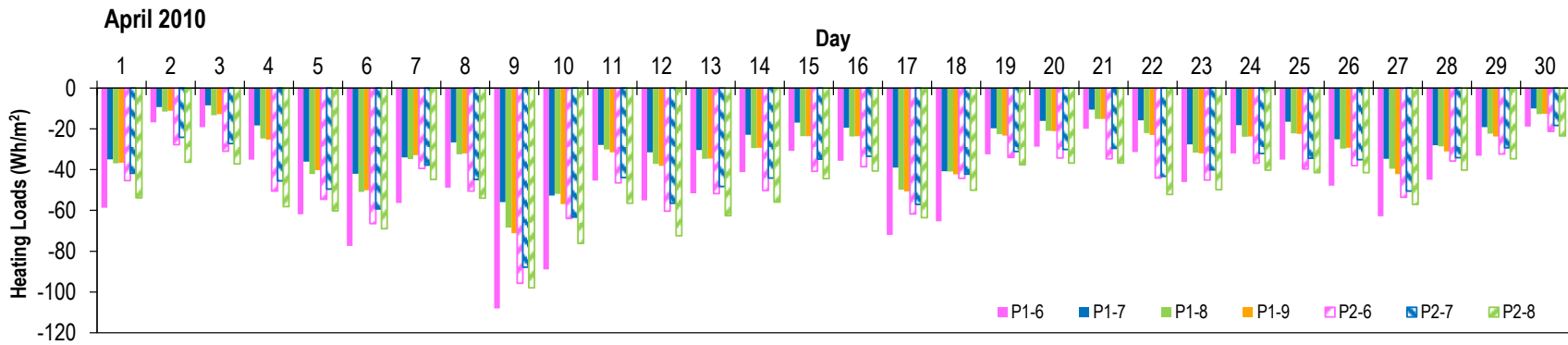
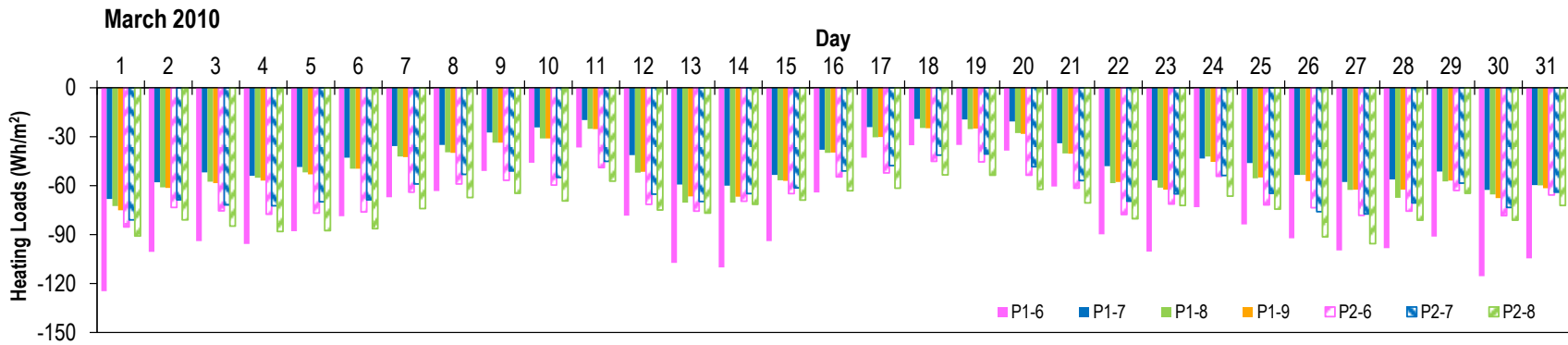

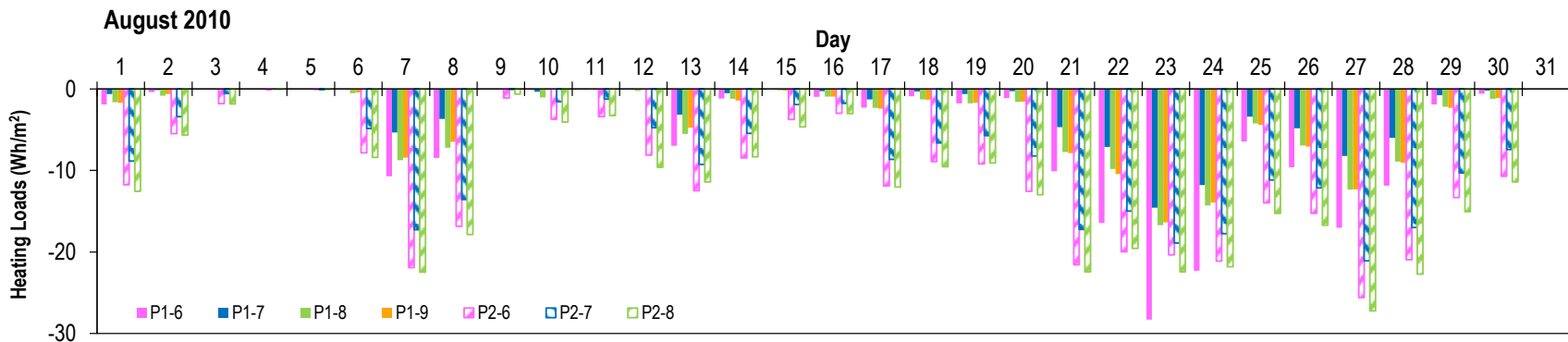
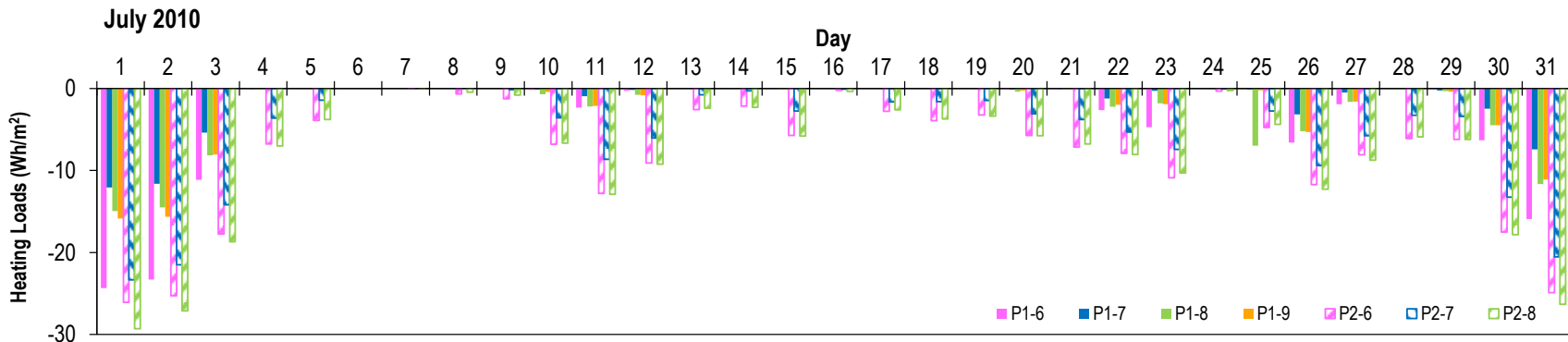
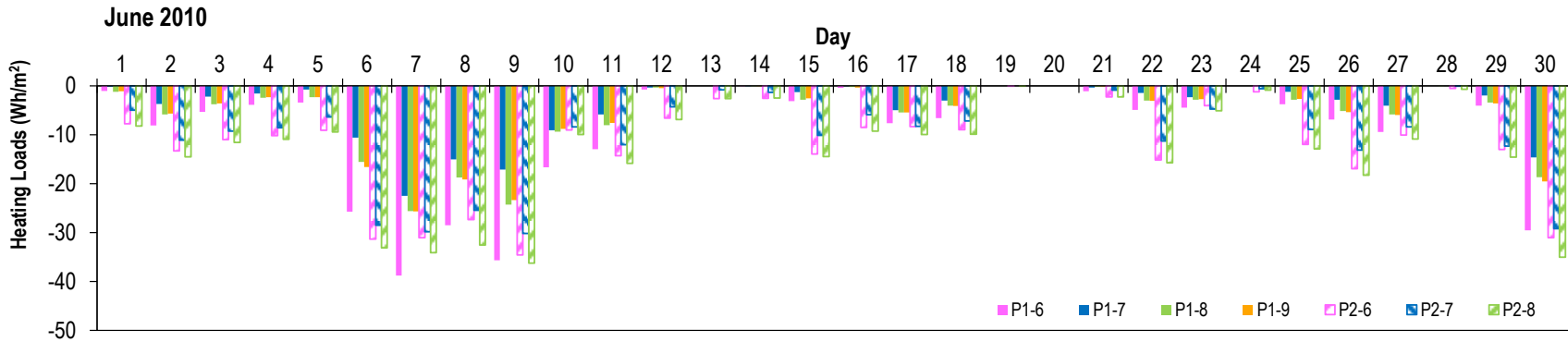

Appendix D: West Panels

Temperature (°C) at exterior side of stud cavity. Refer to Figures 25 thru 28 for sensor location.

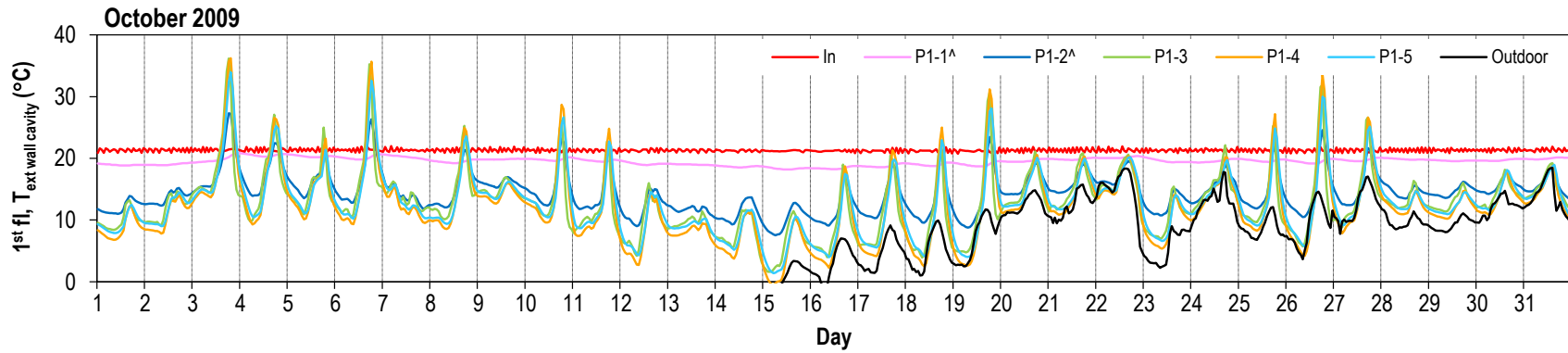
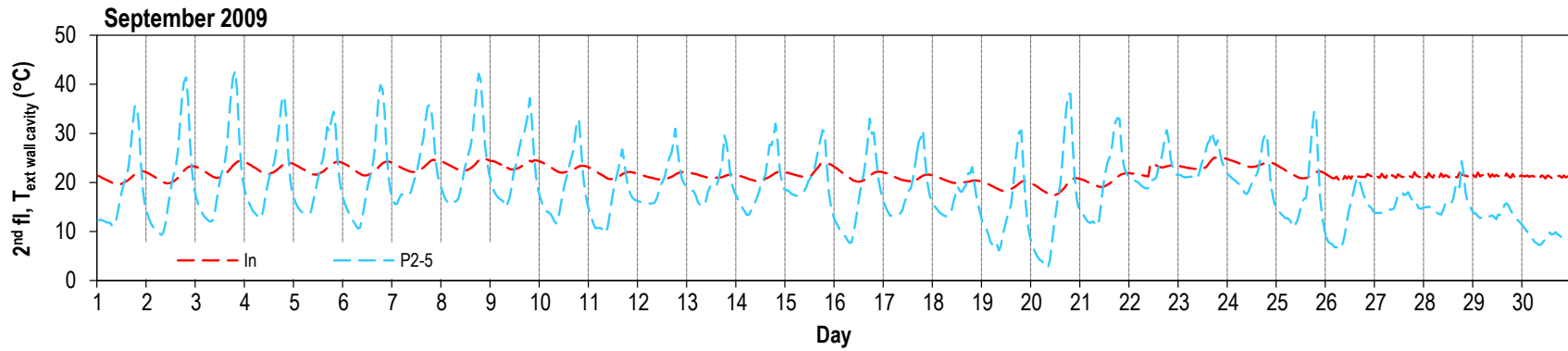
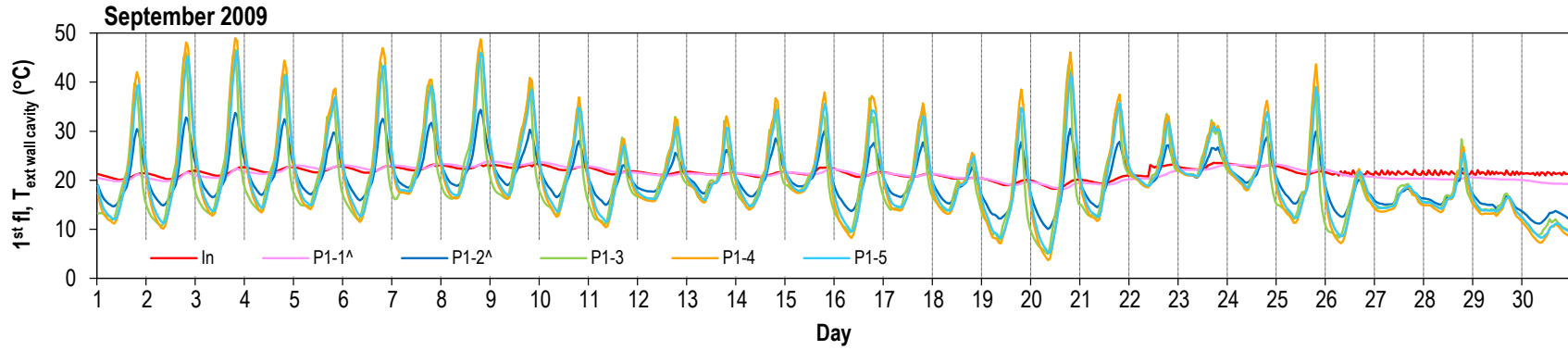

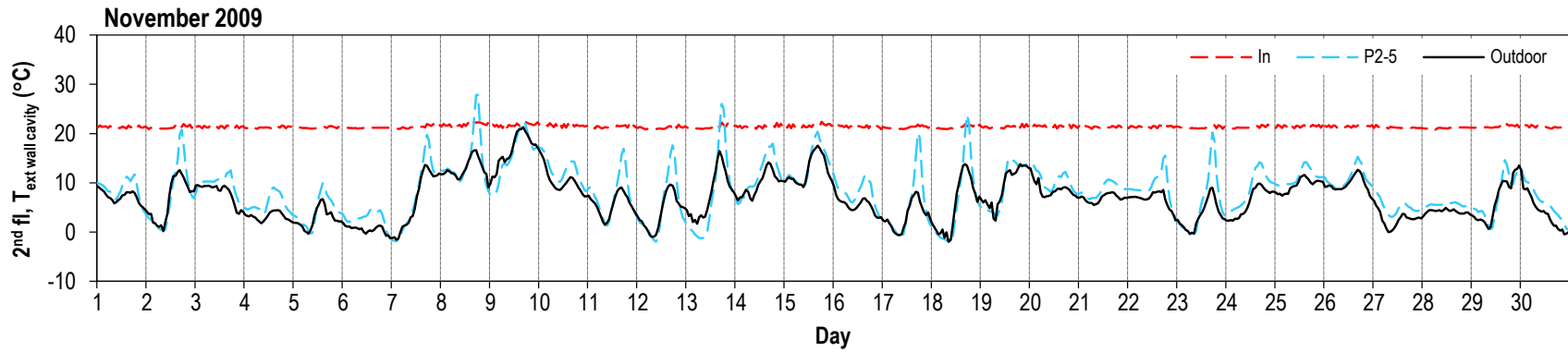
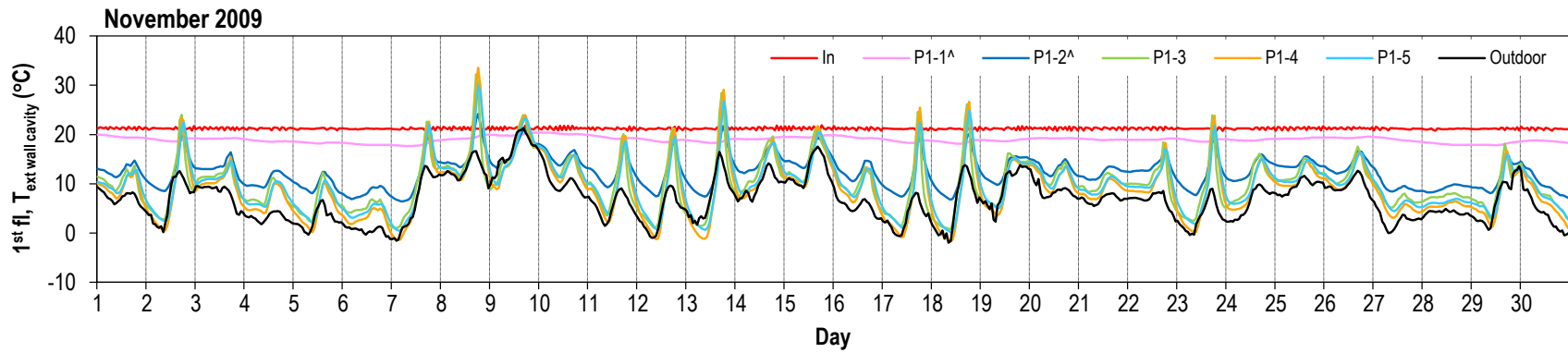
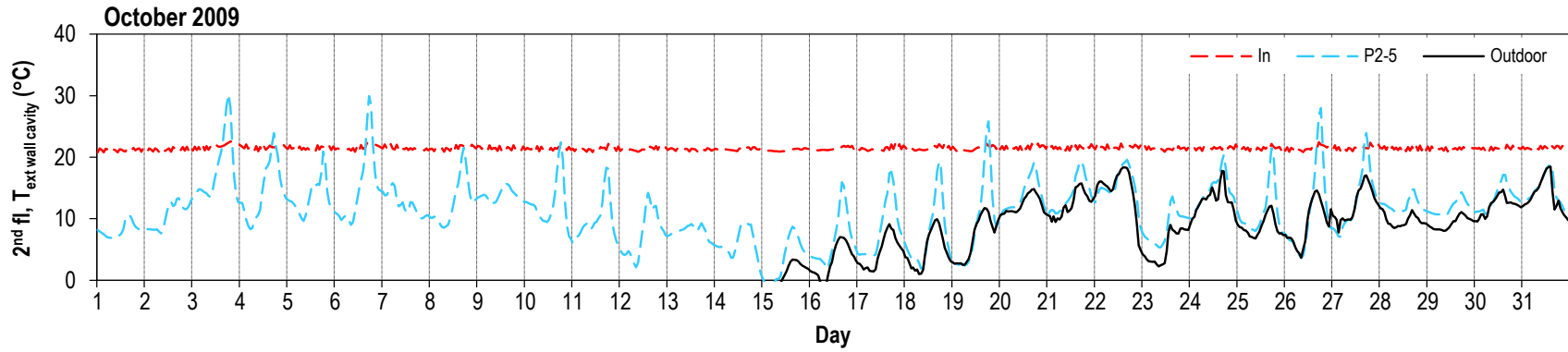

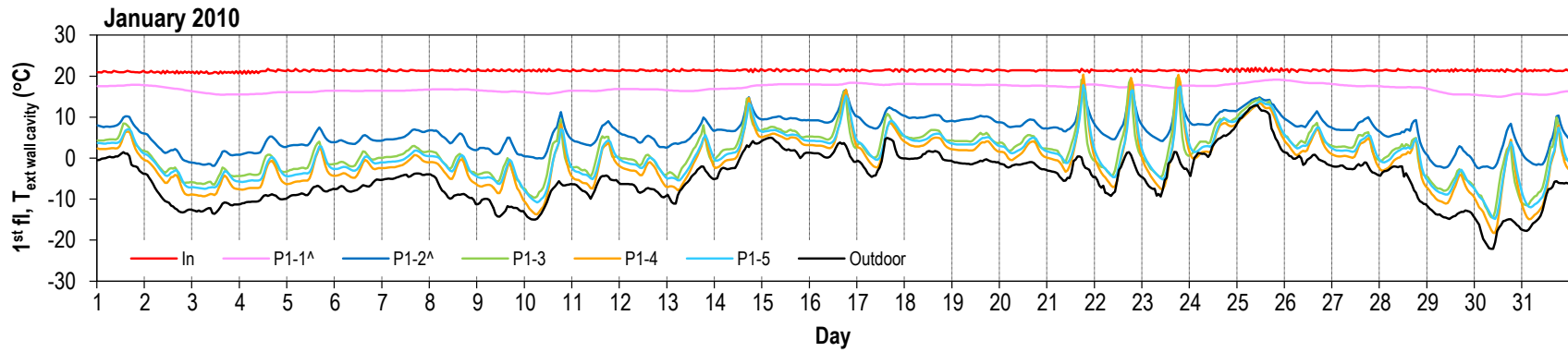
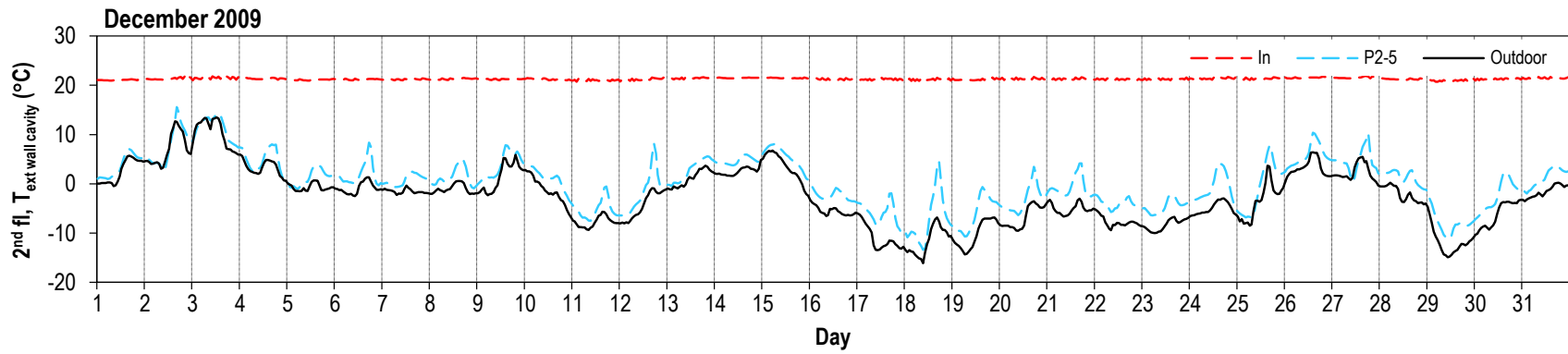
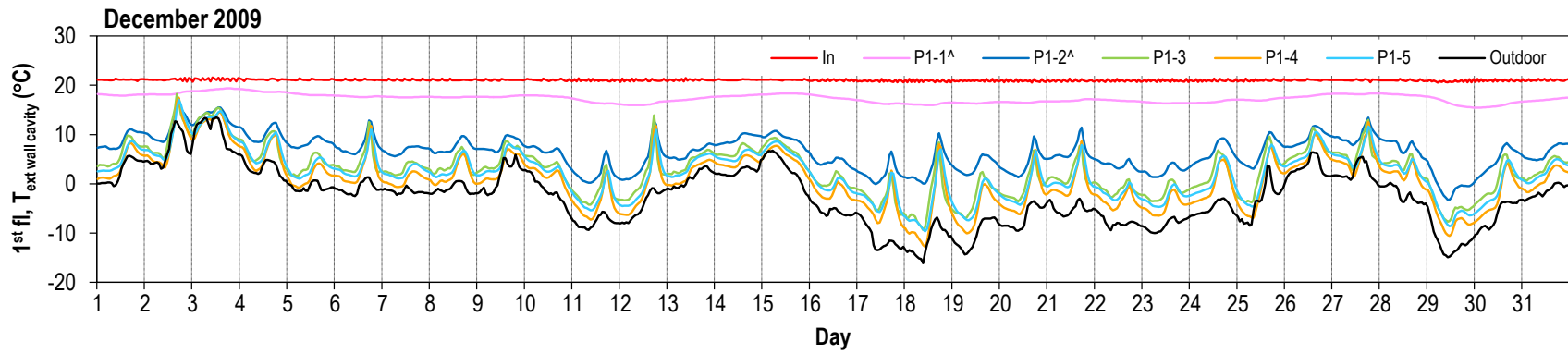

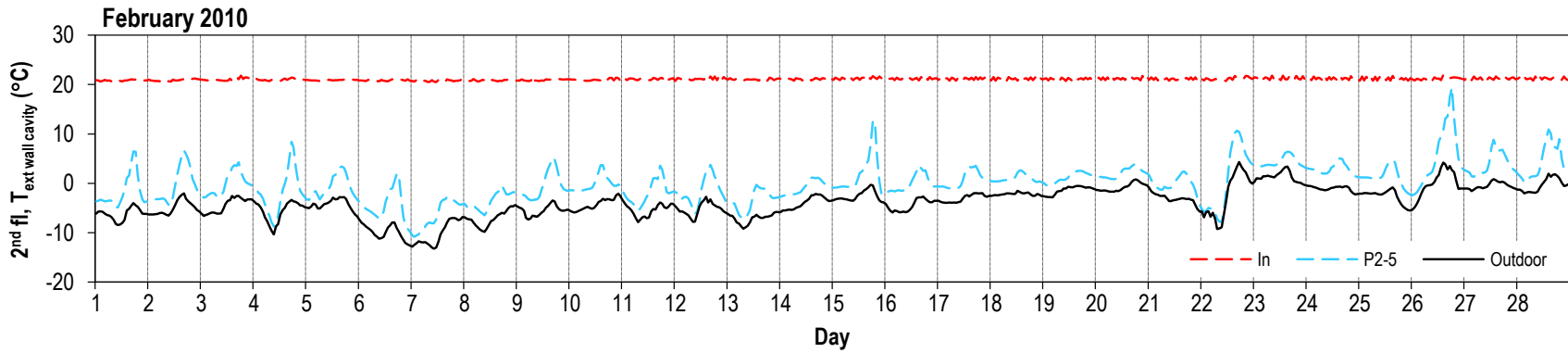
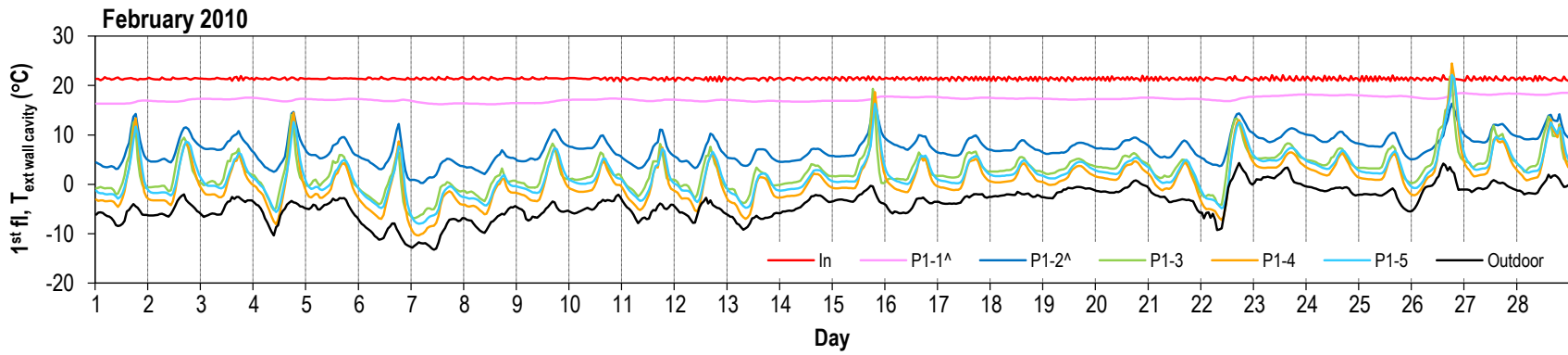
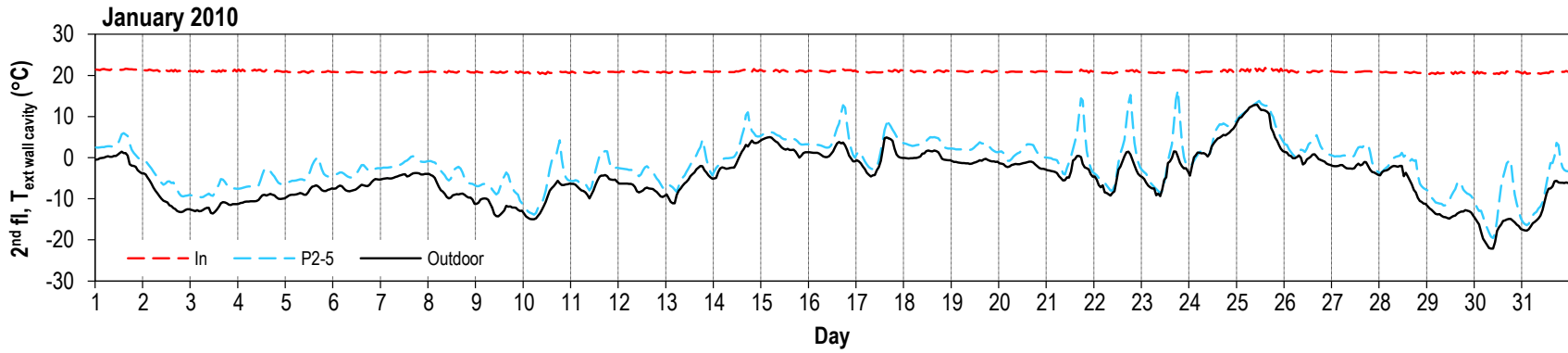

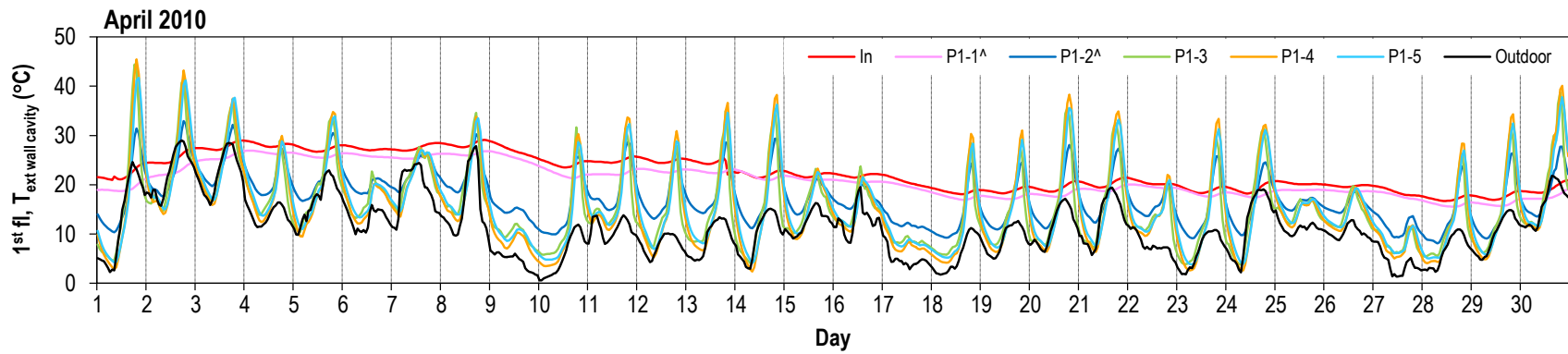
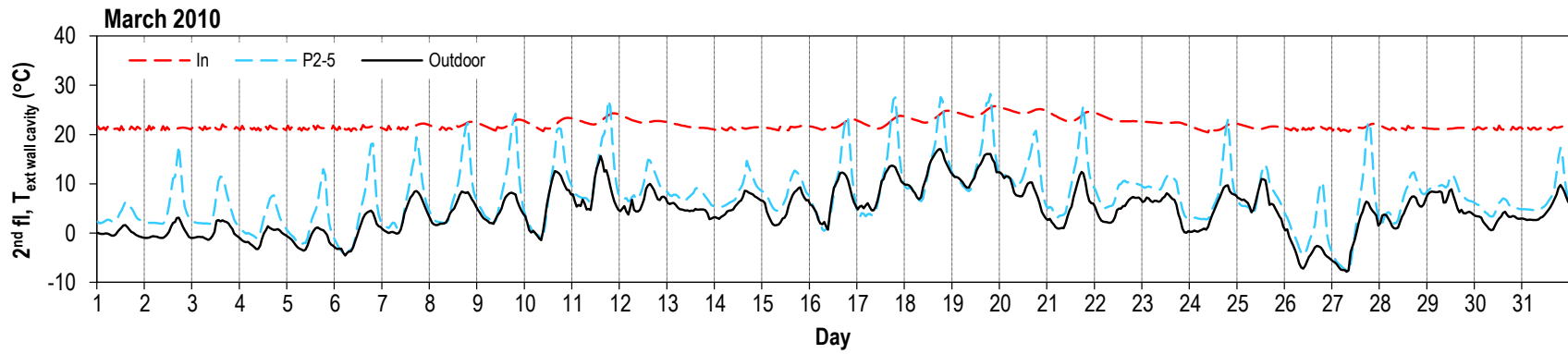
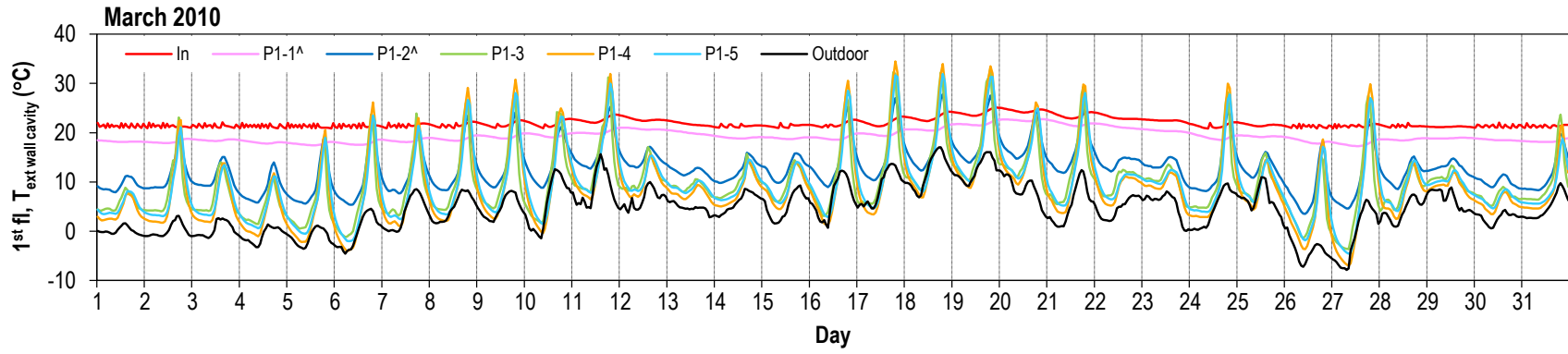

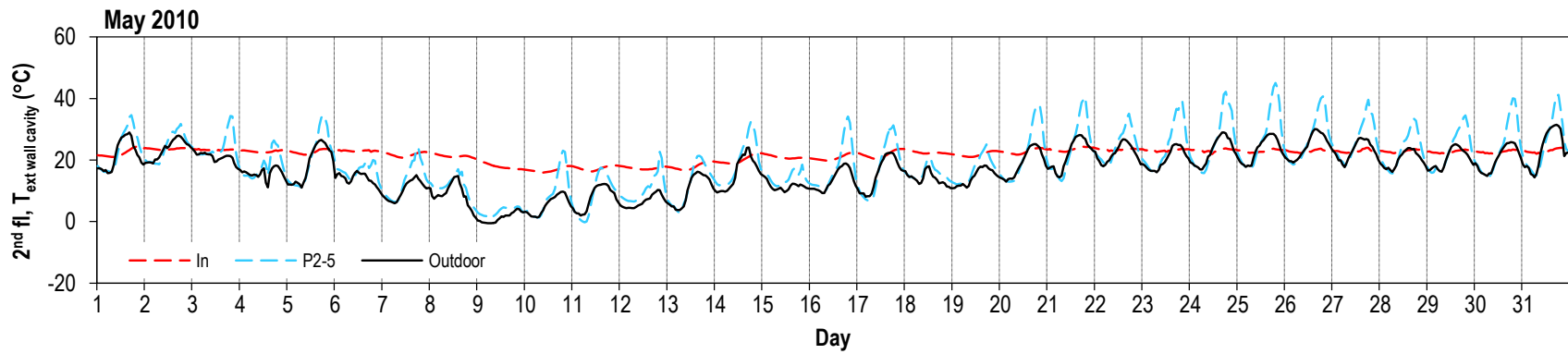
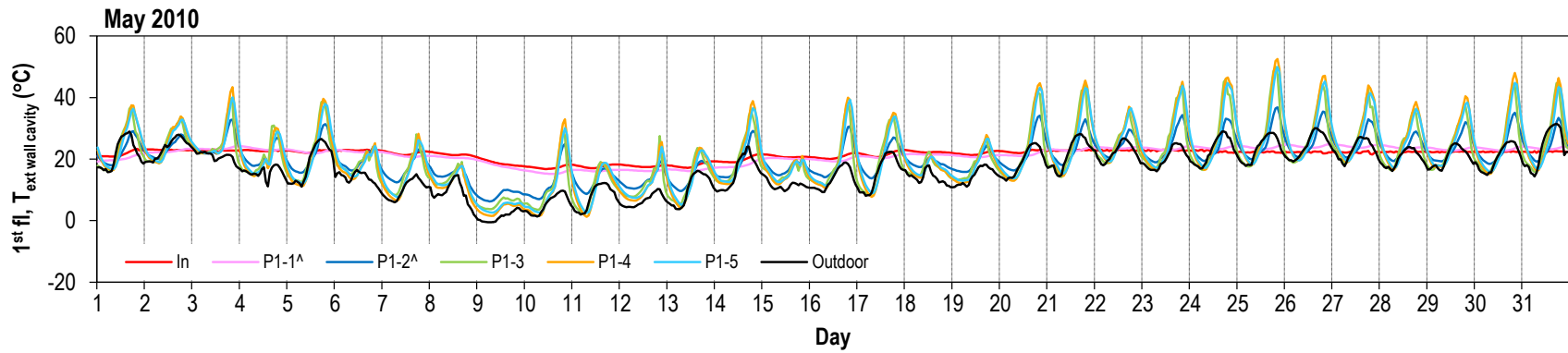
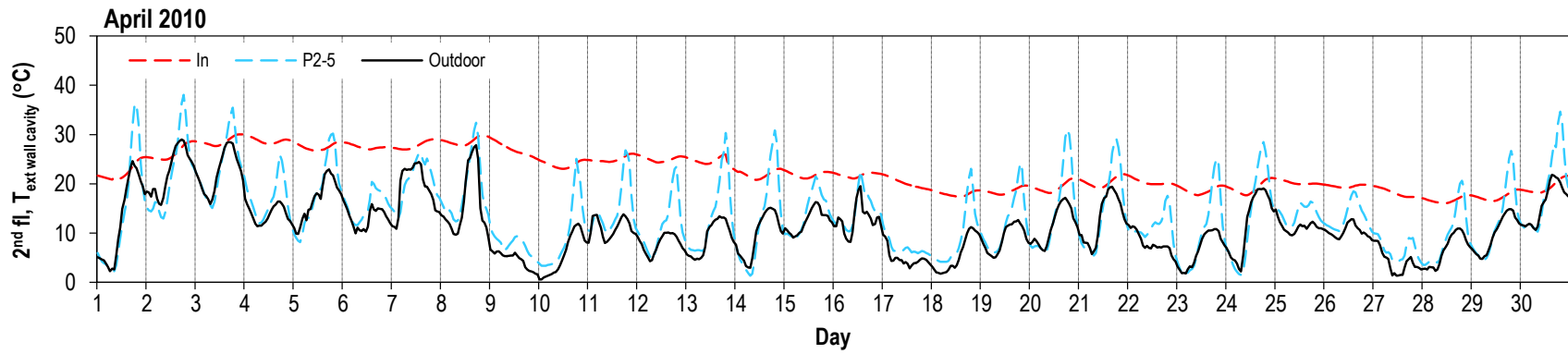

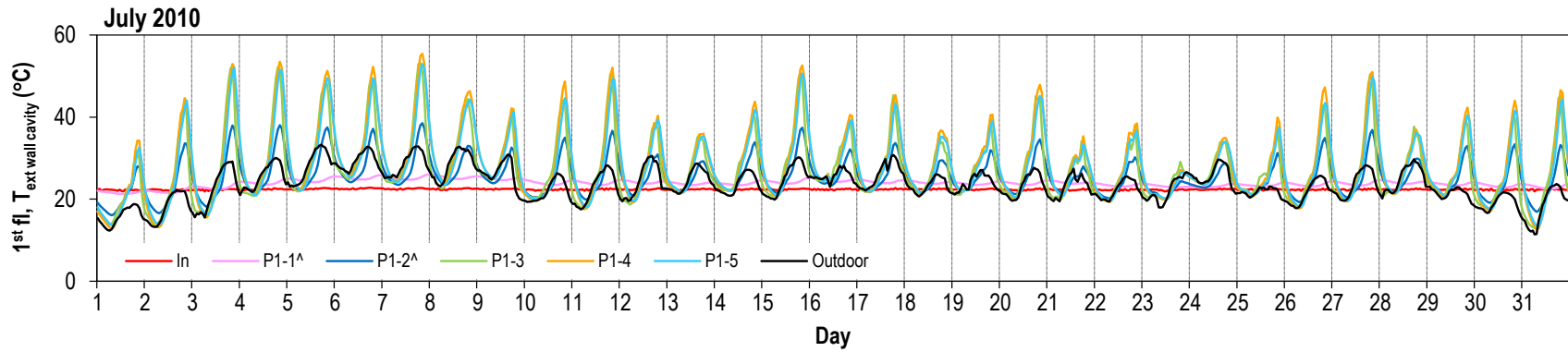
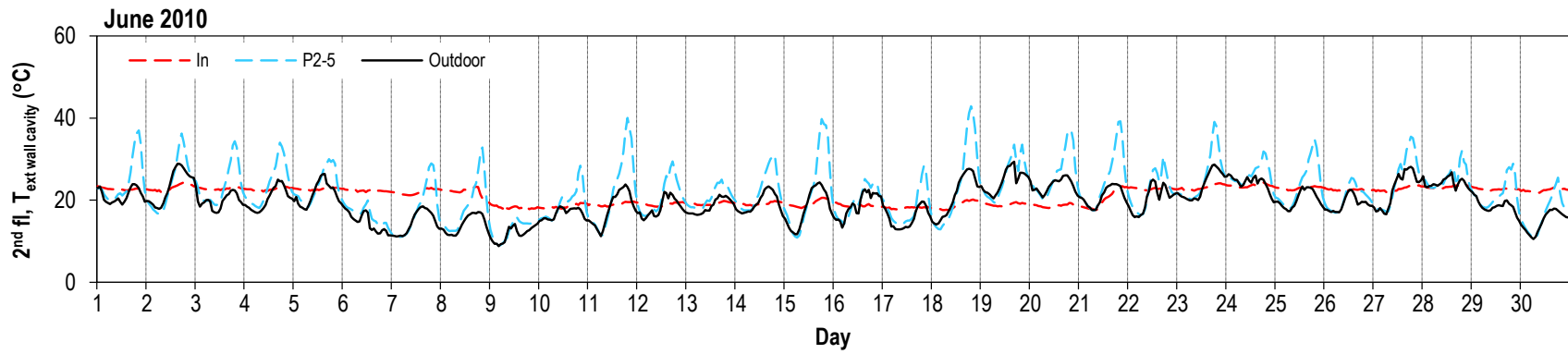
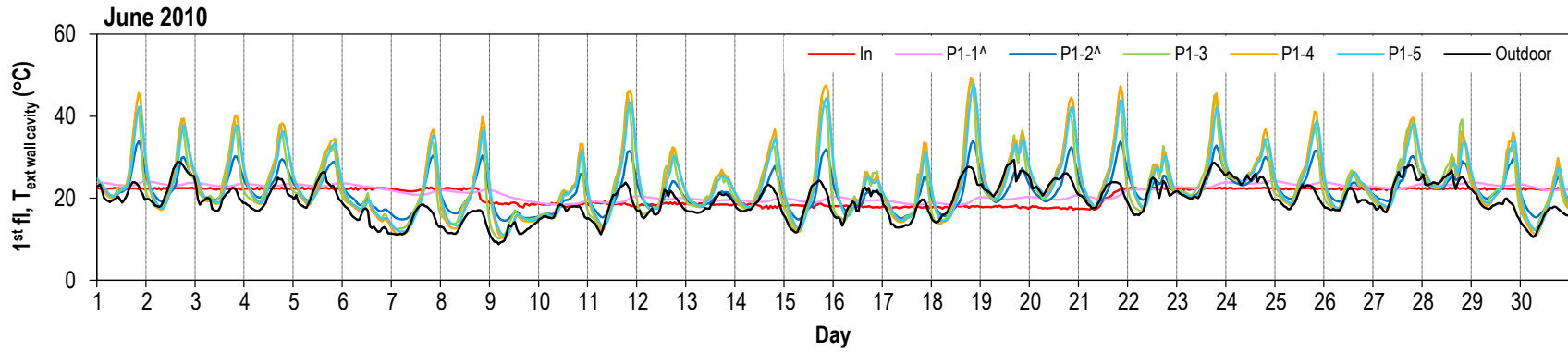

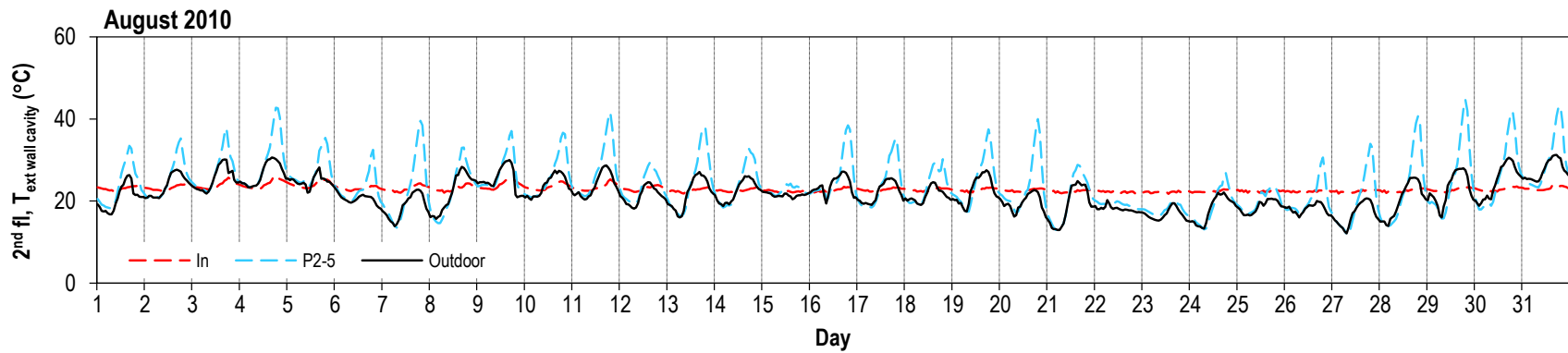
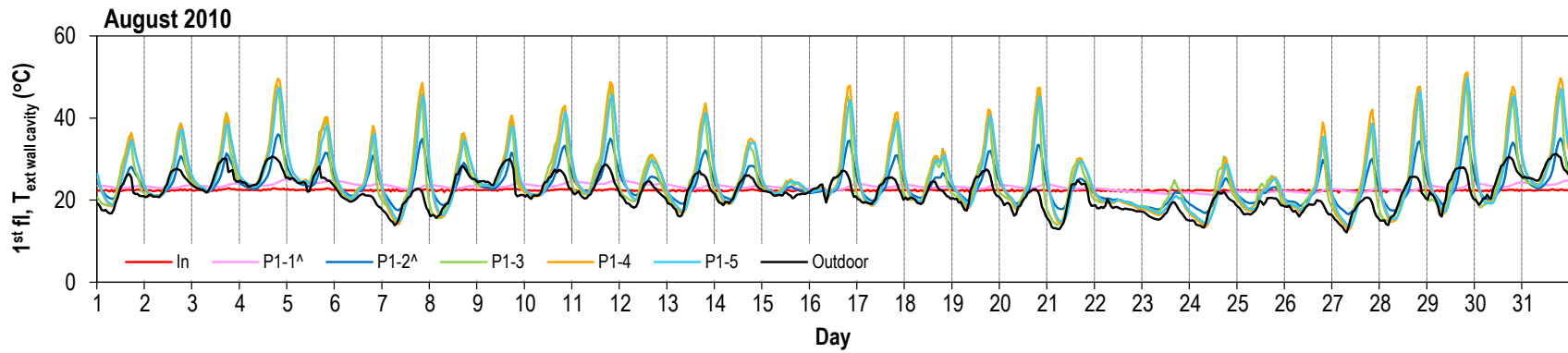
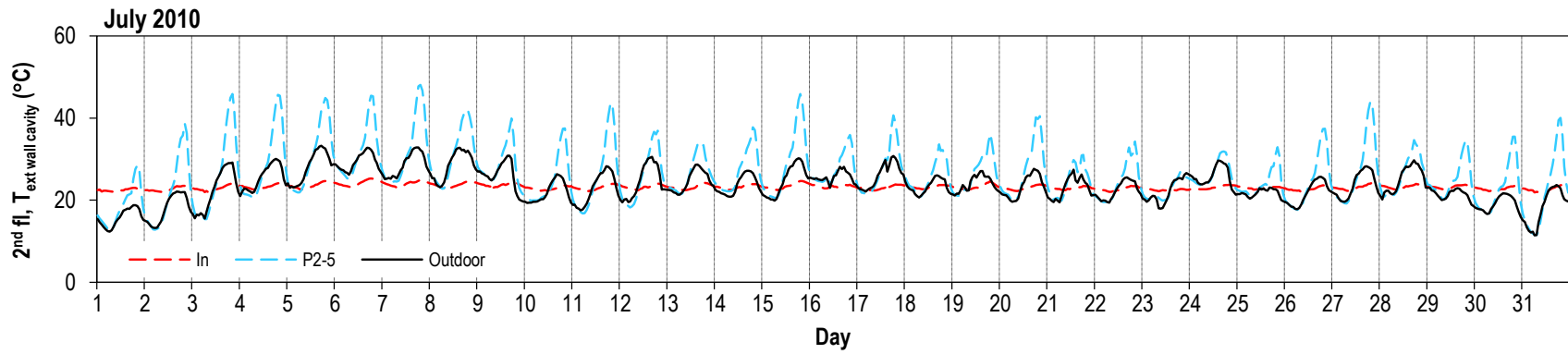

Temperature (°C) at interior side of stud cavity. Refer to Figures 25 thru 28 for sensor location.

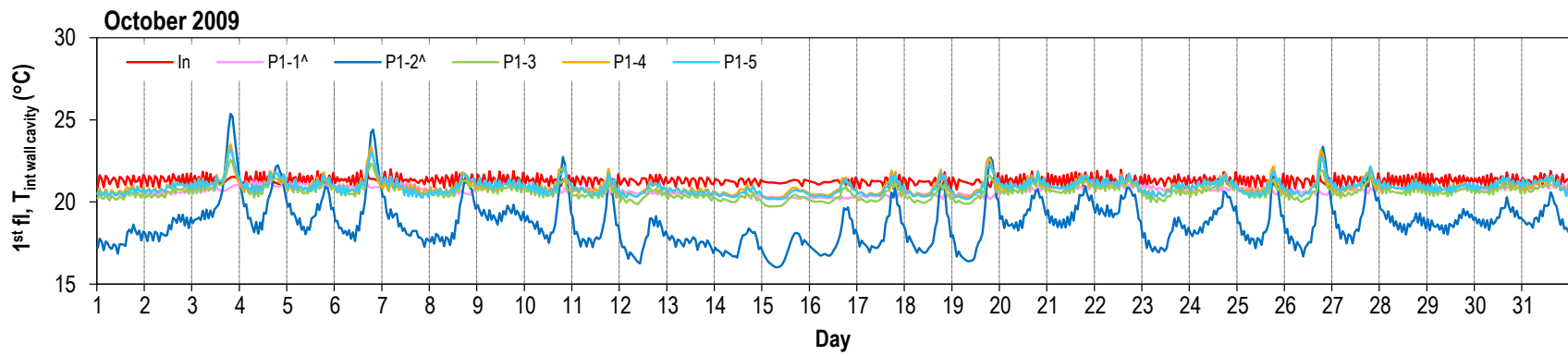
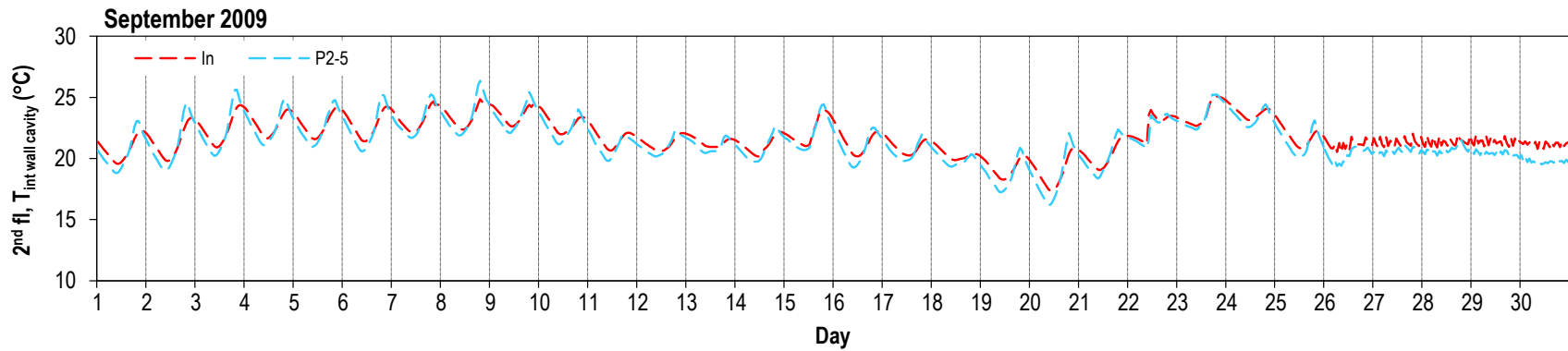
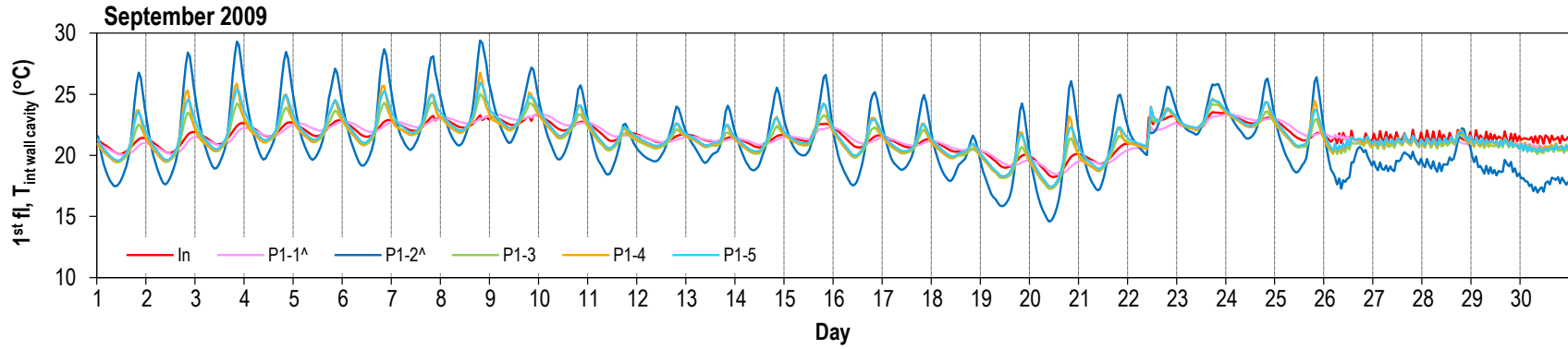

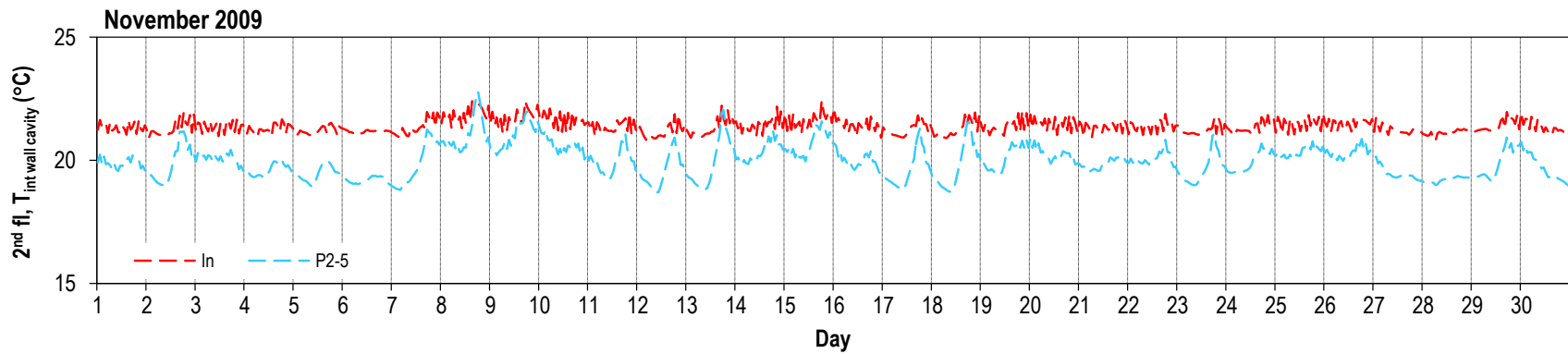
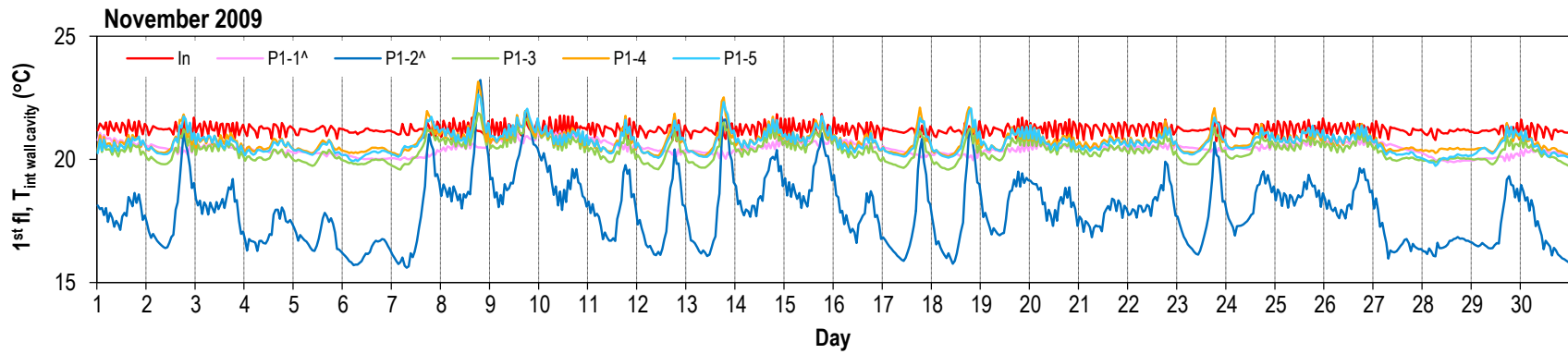
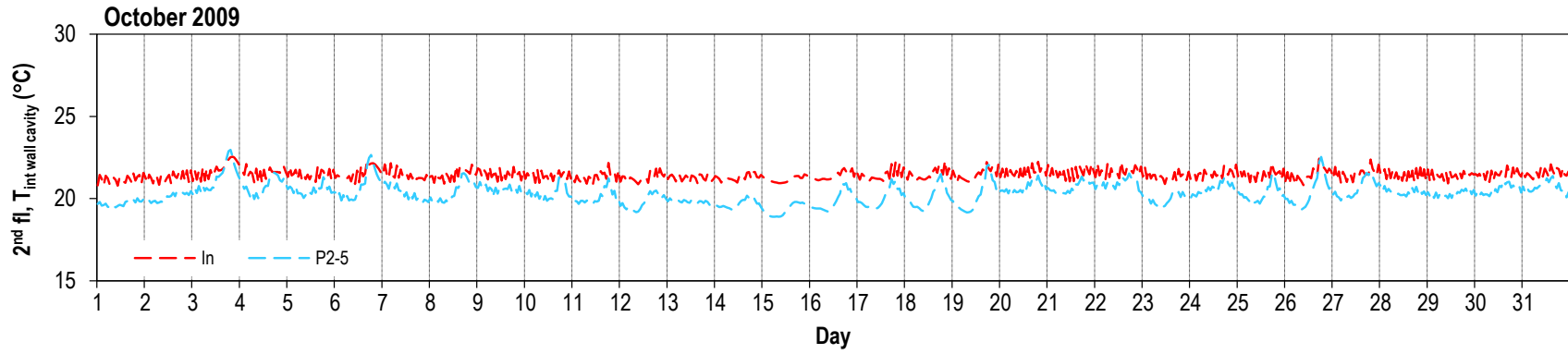

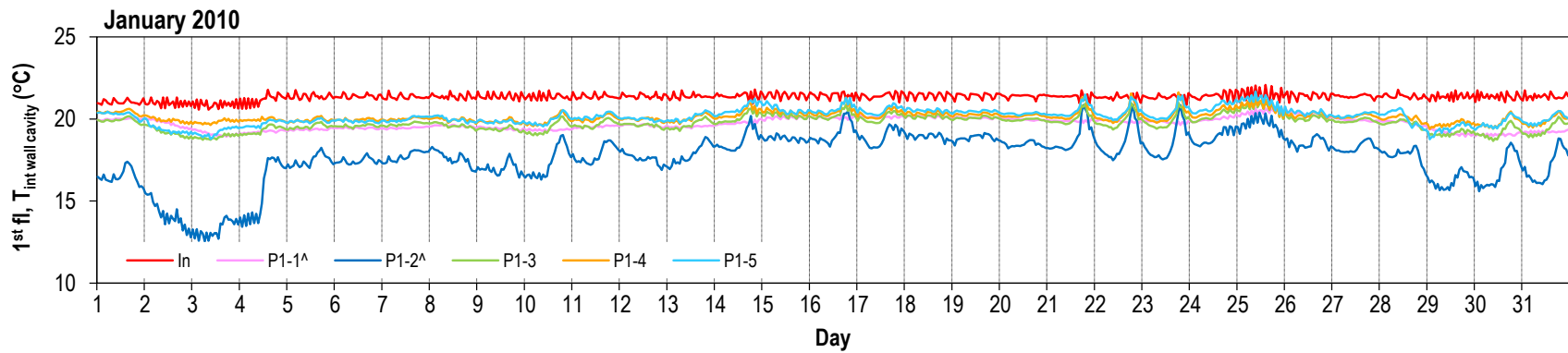
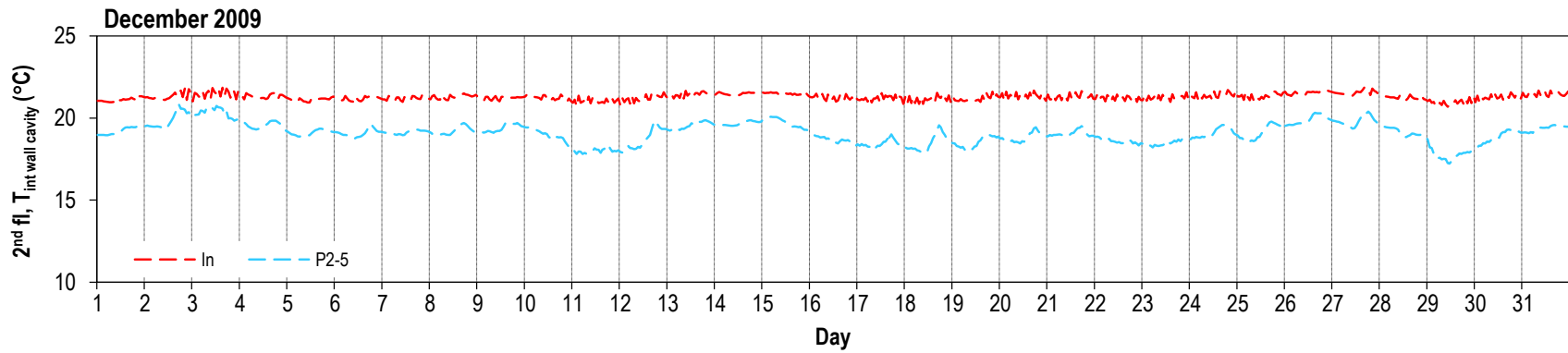
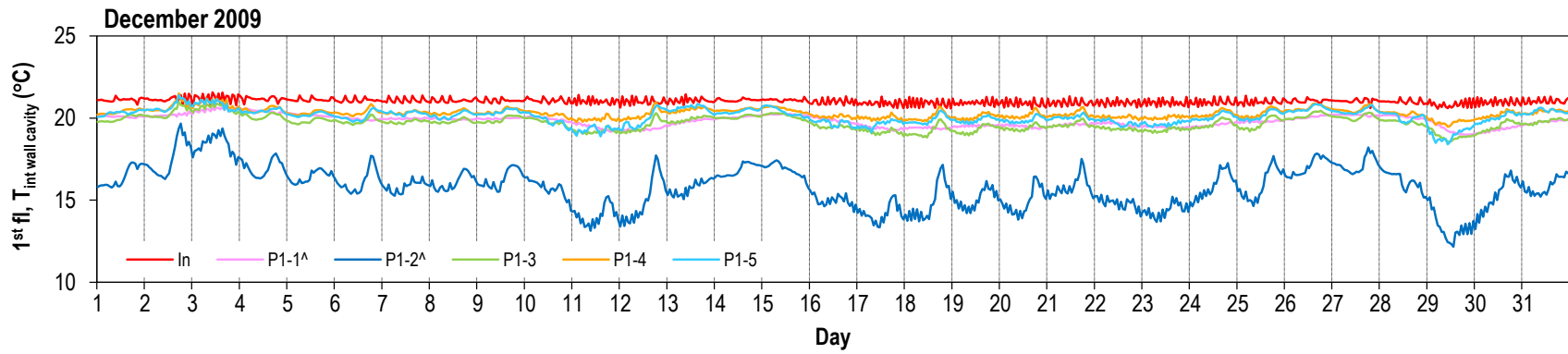

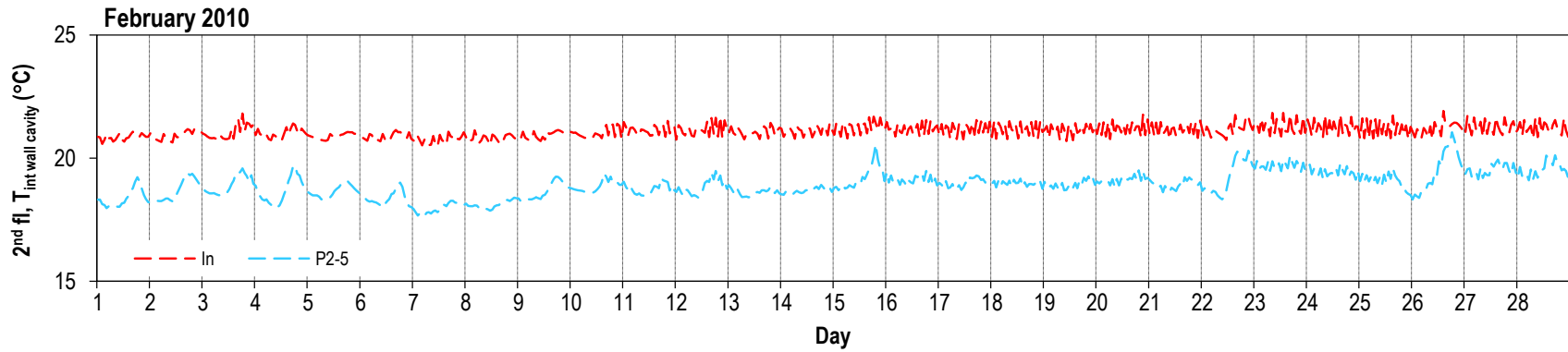
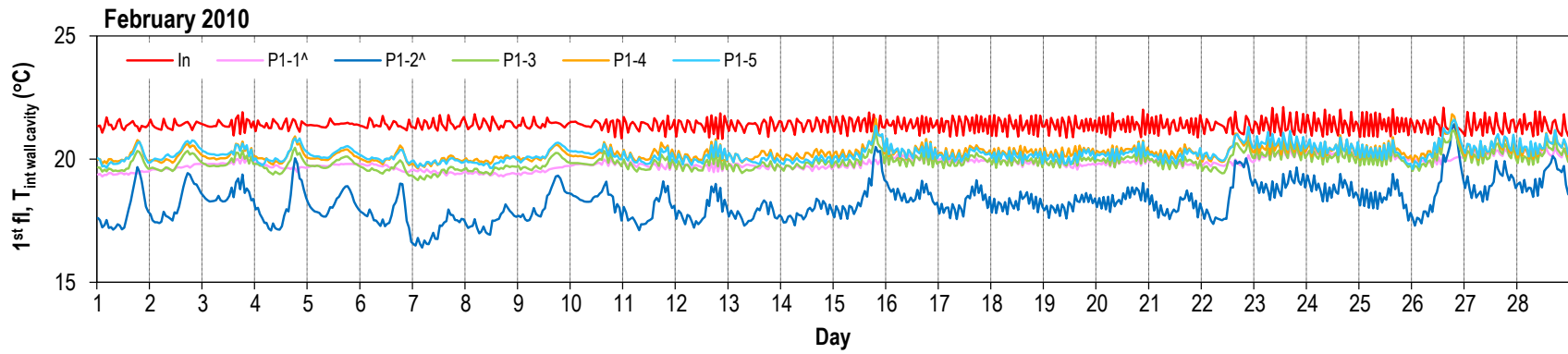
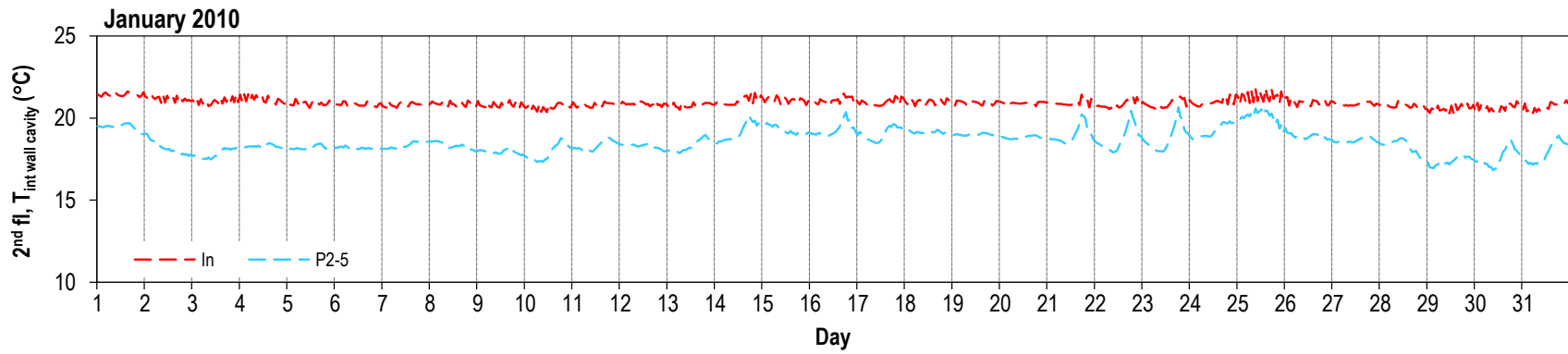

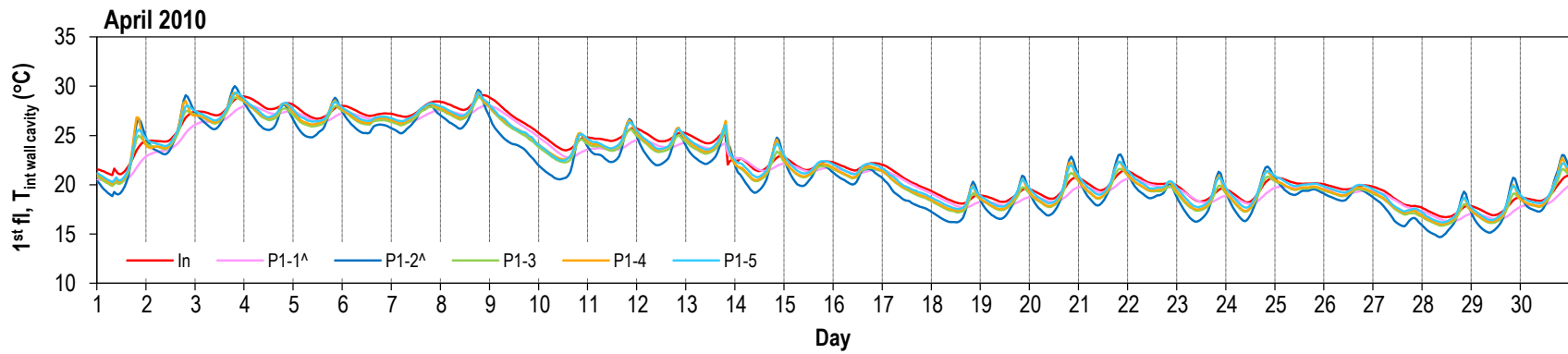
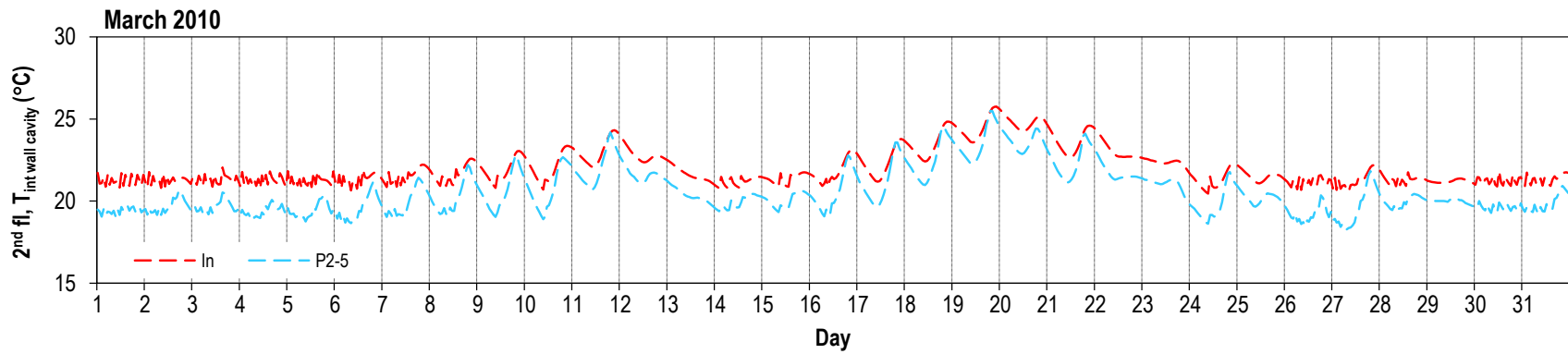
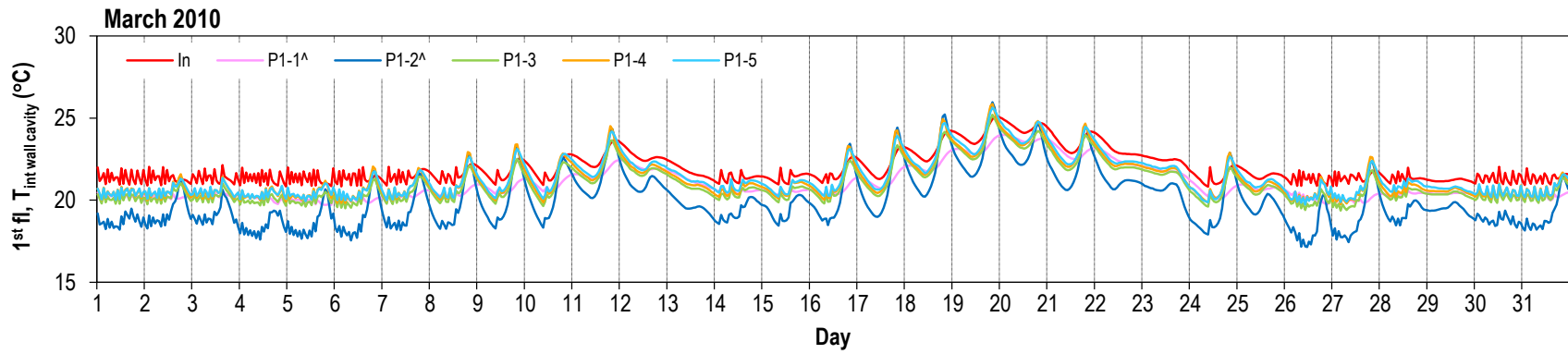

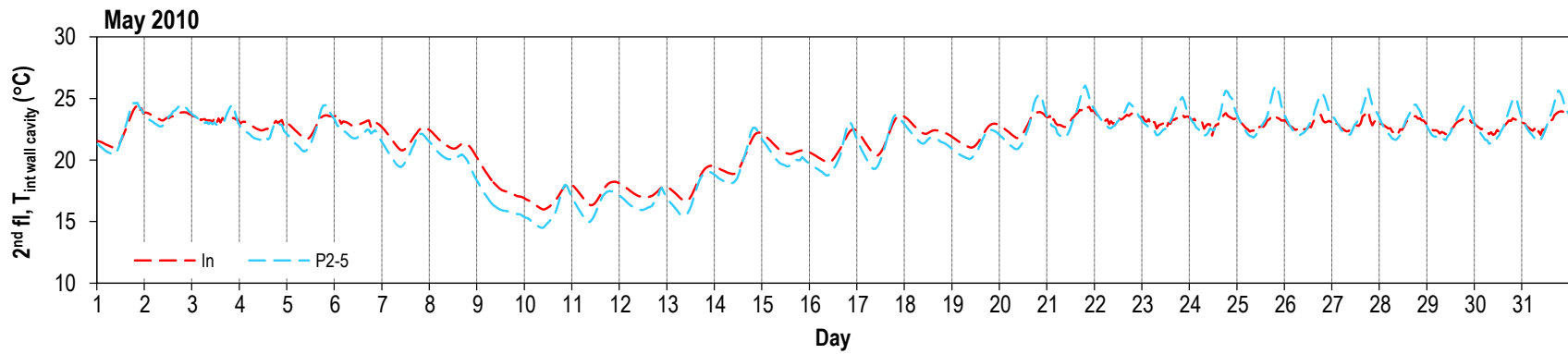
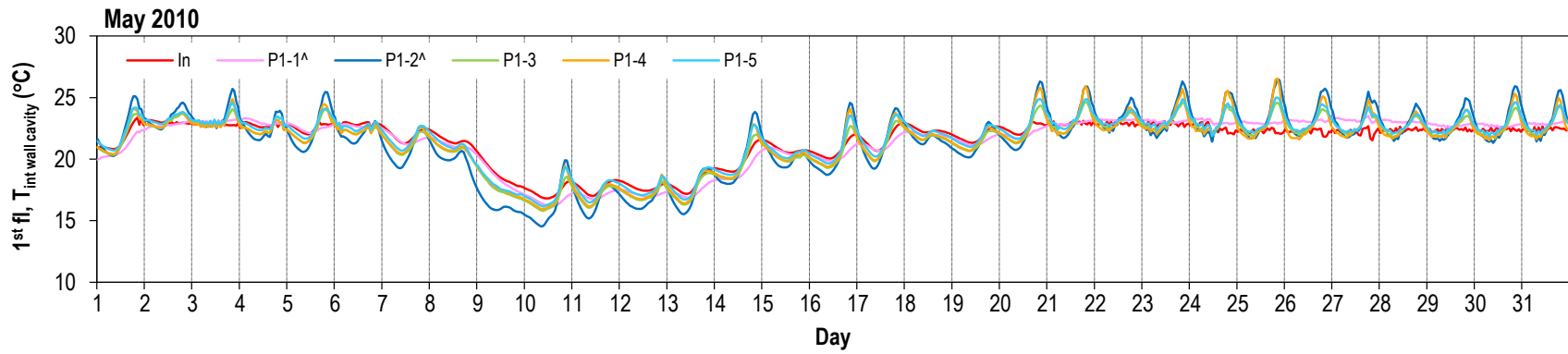
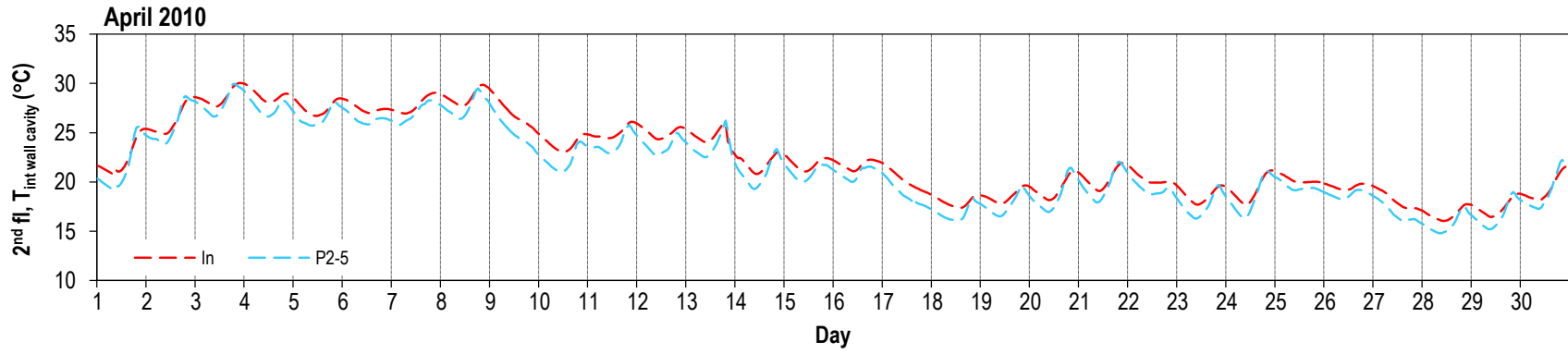

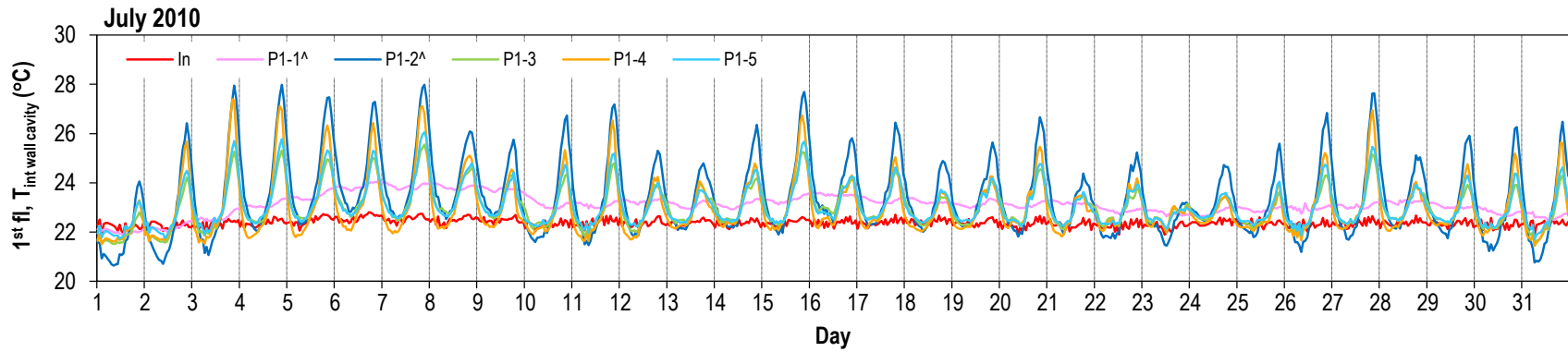
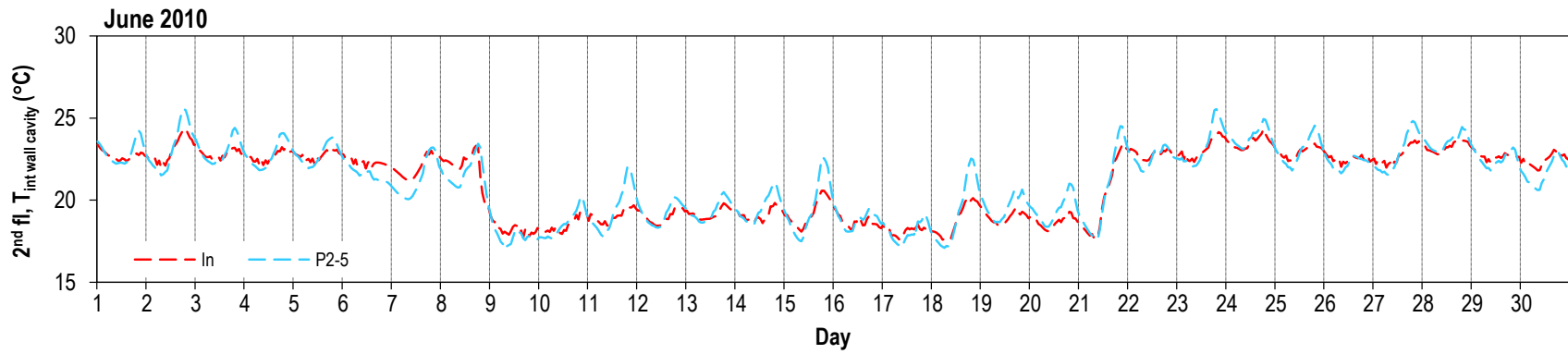
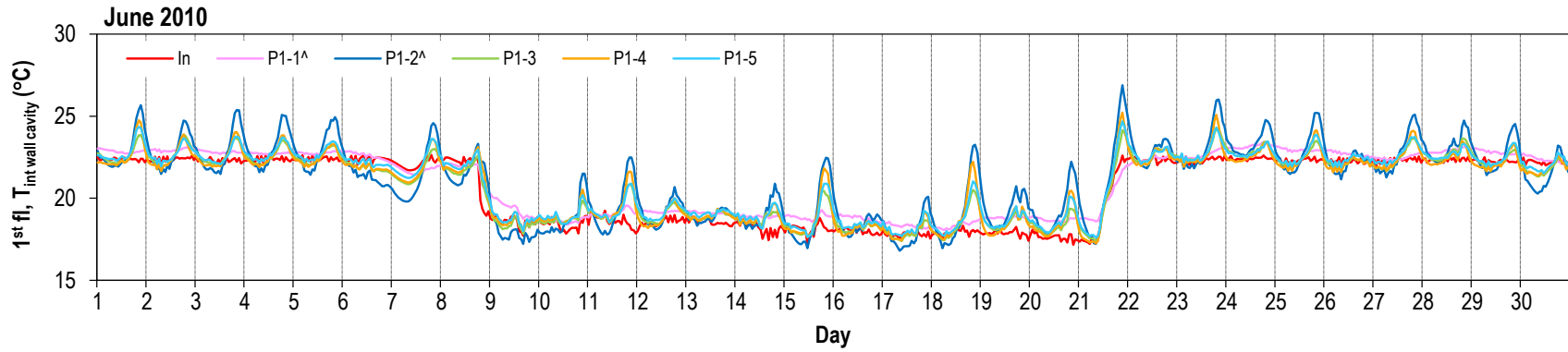

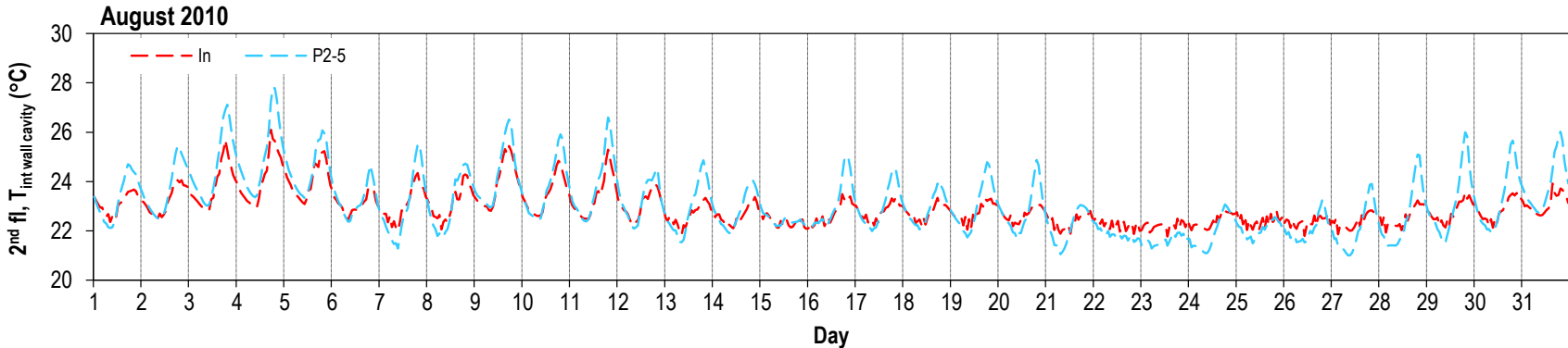
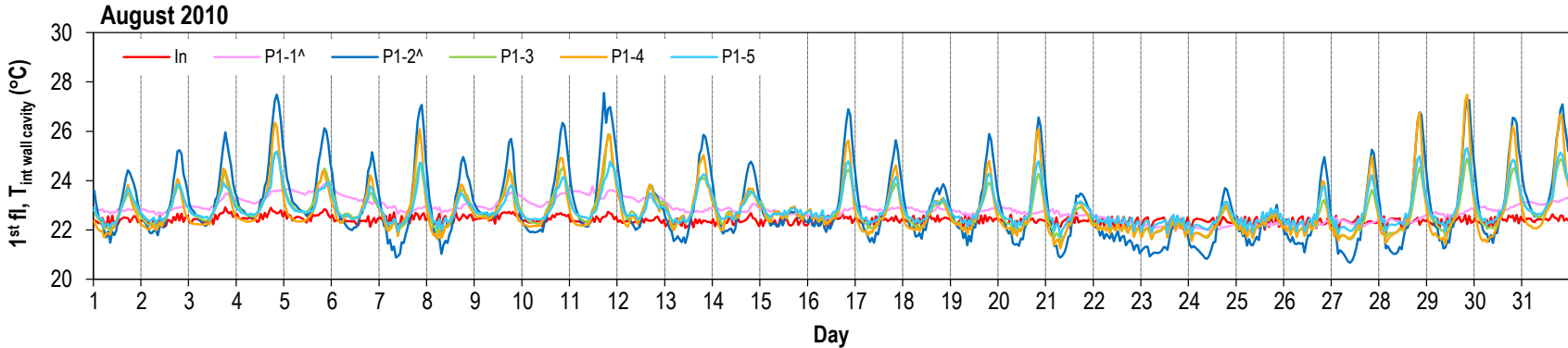
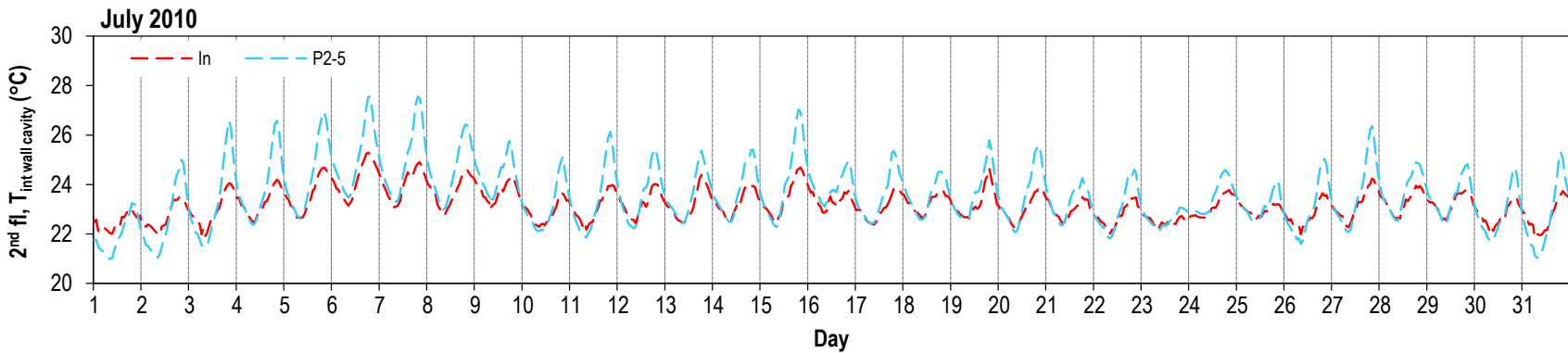

Relative humidity (%) at exterior side of stud cavity. Refer to Figures 25 thru 28 for sensor location.

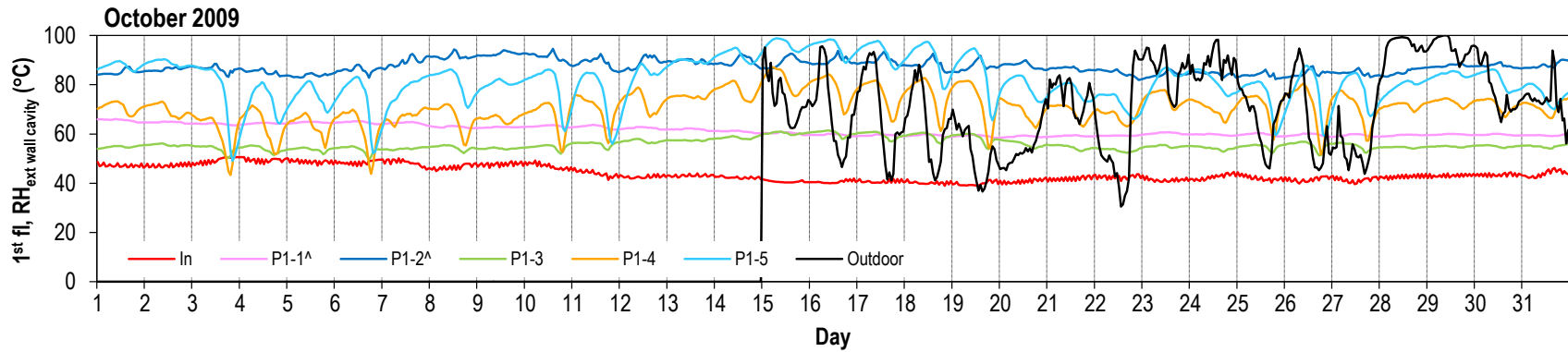
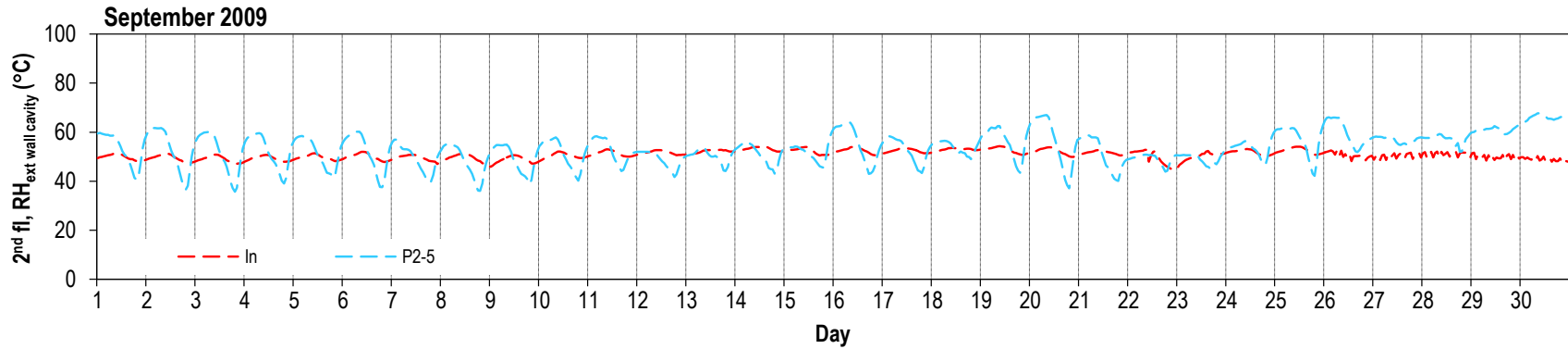
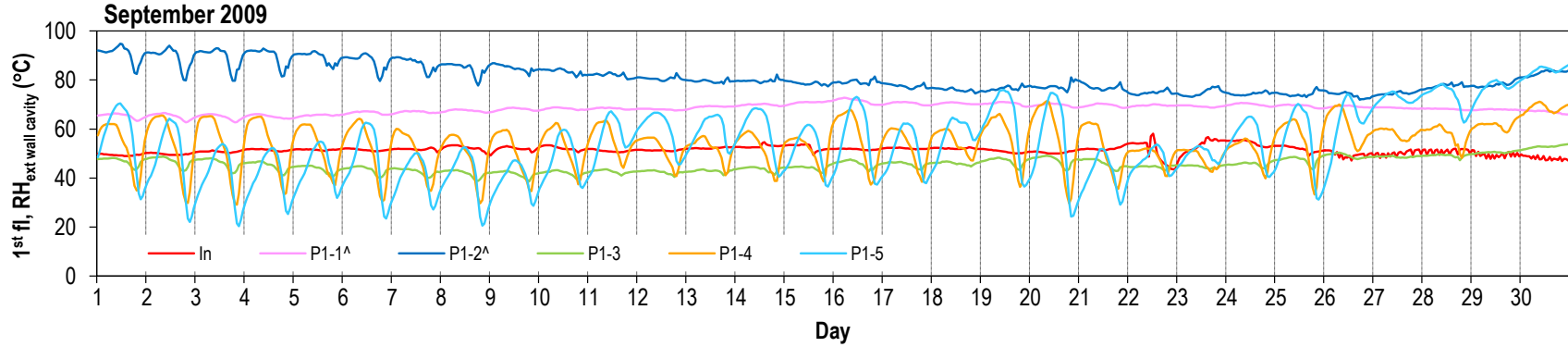

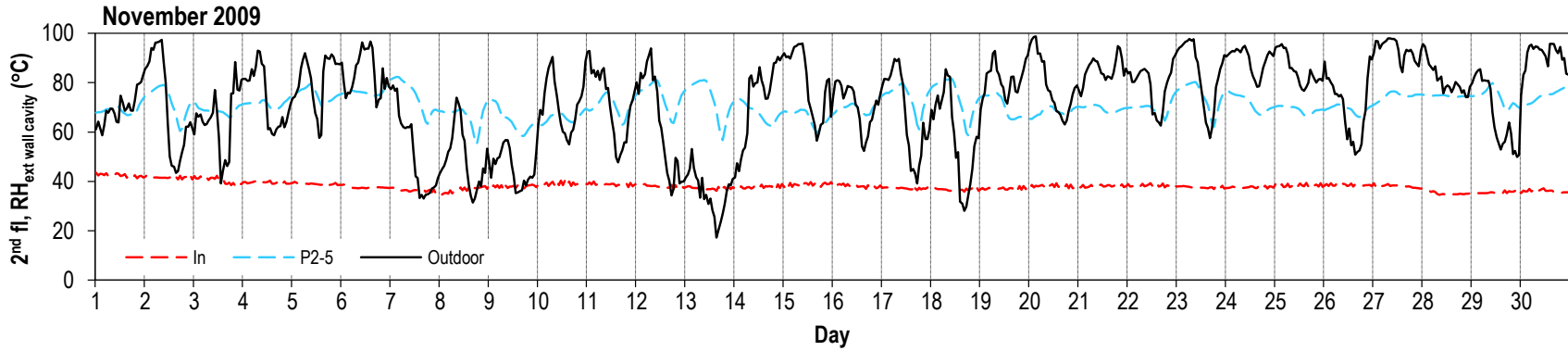
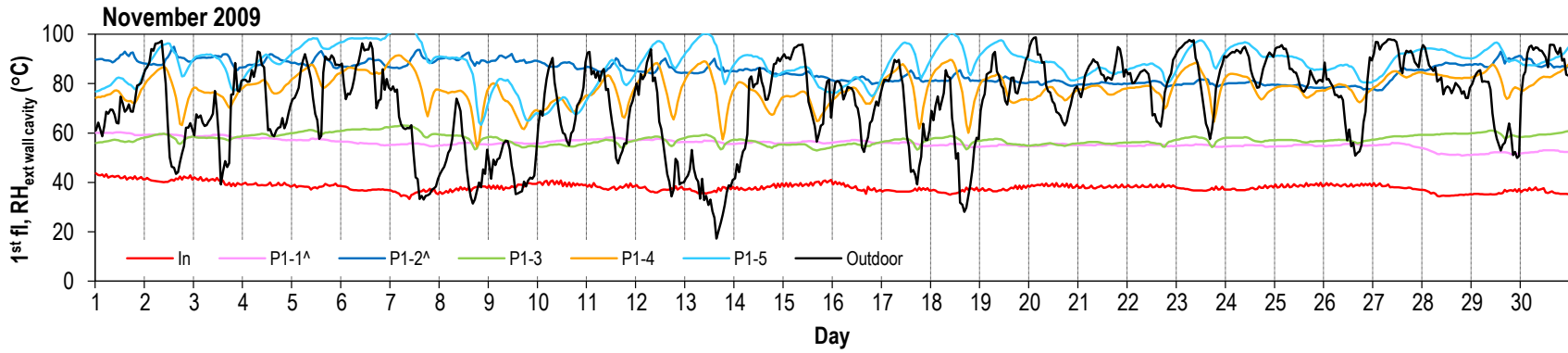
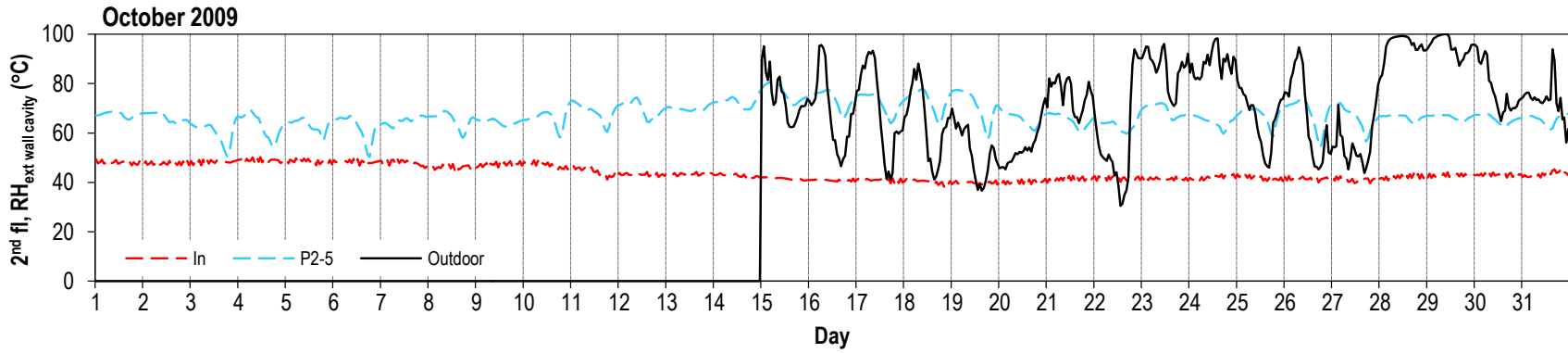

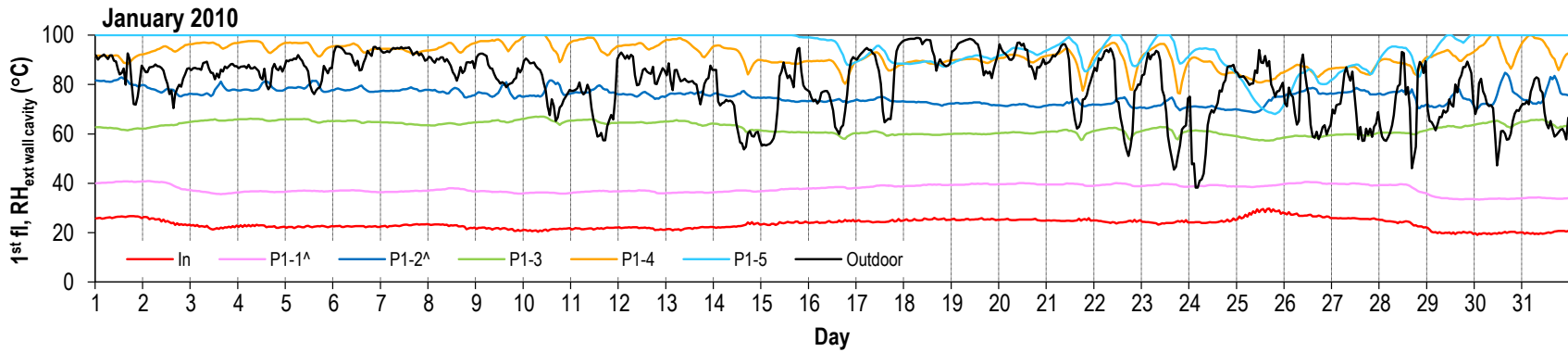
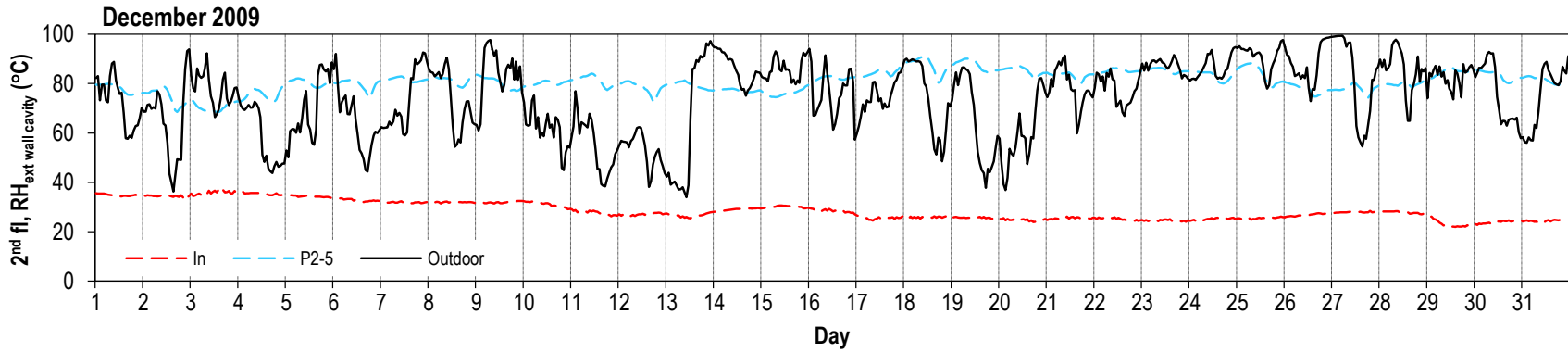
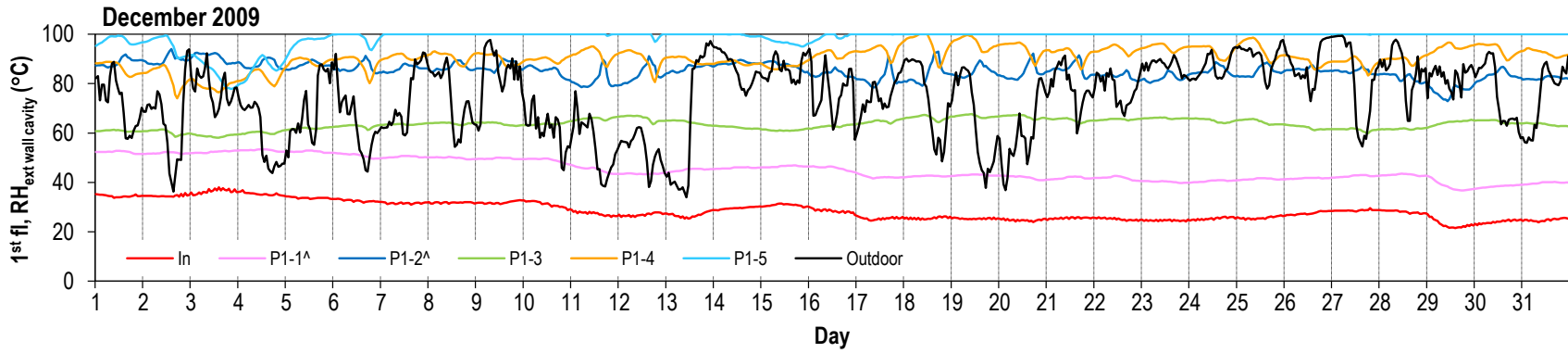

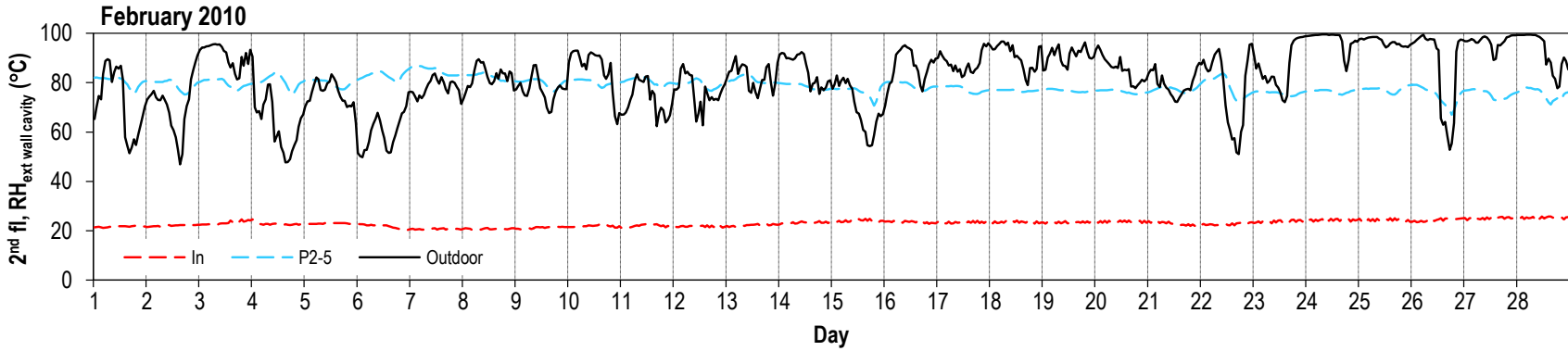
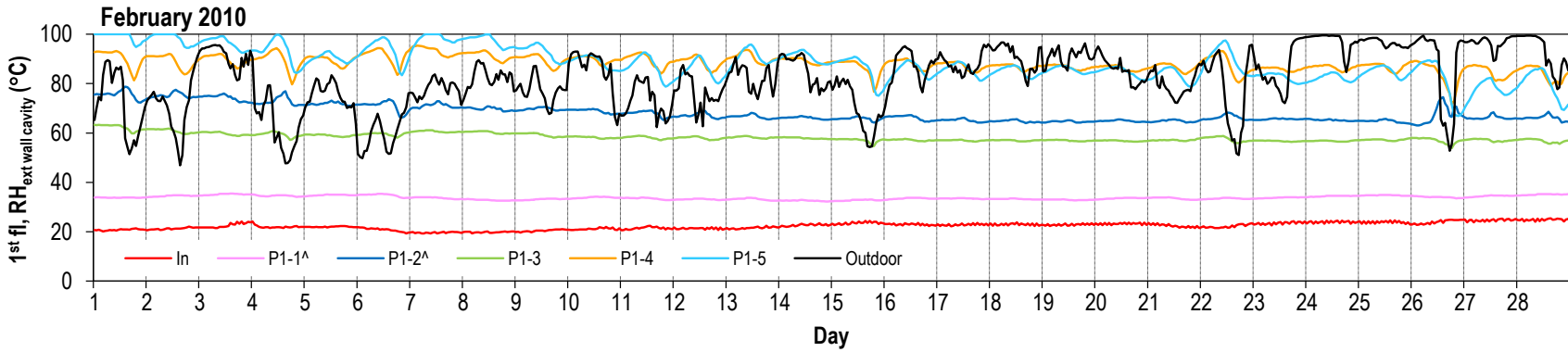
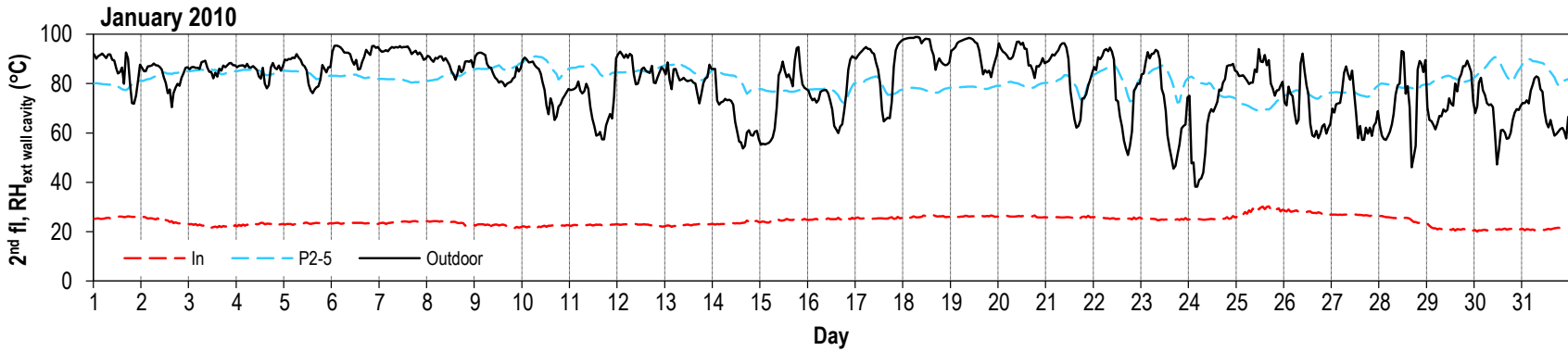

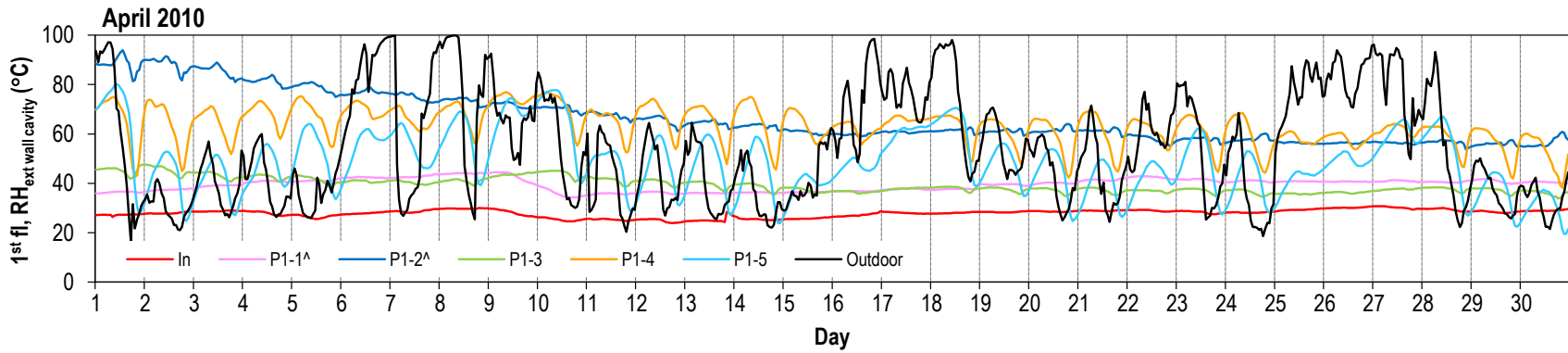
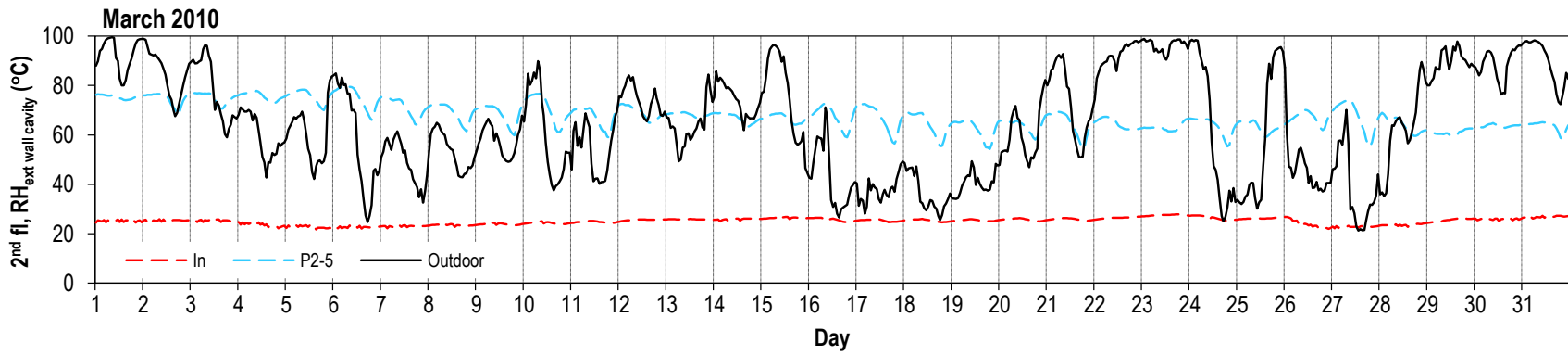
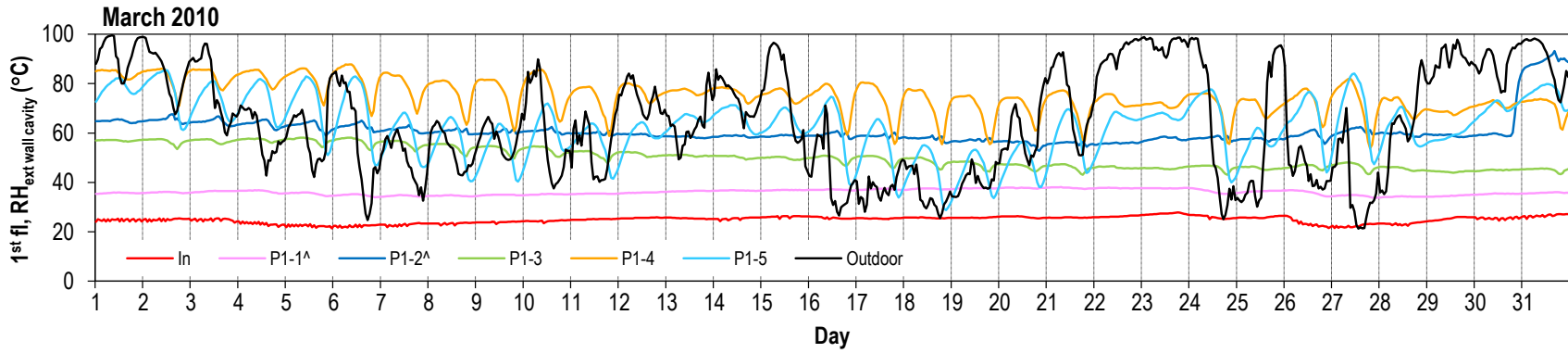

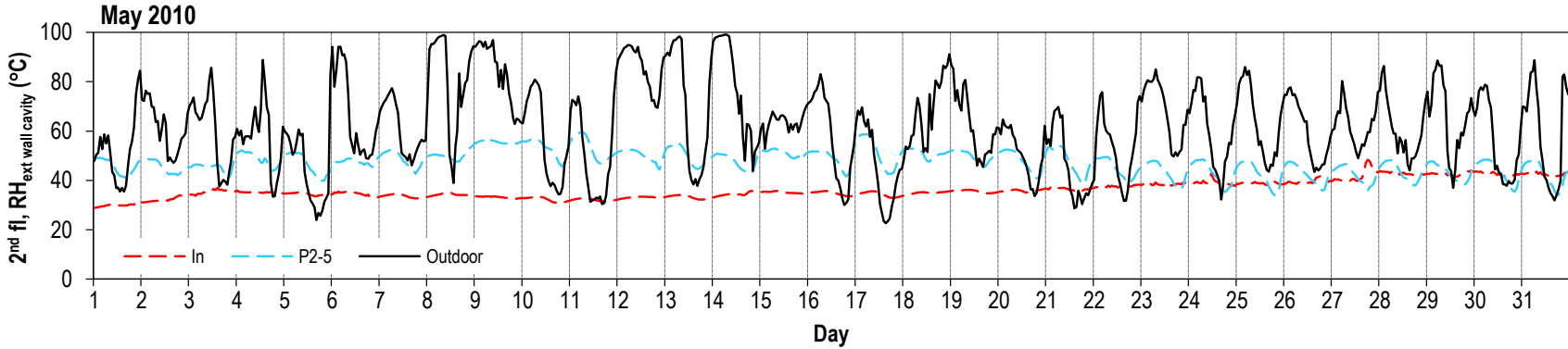
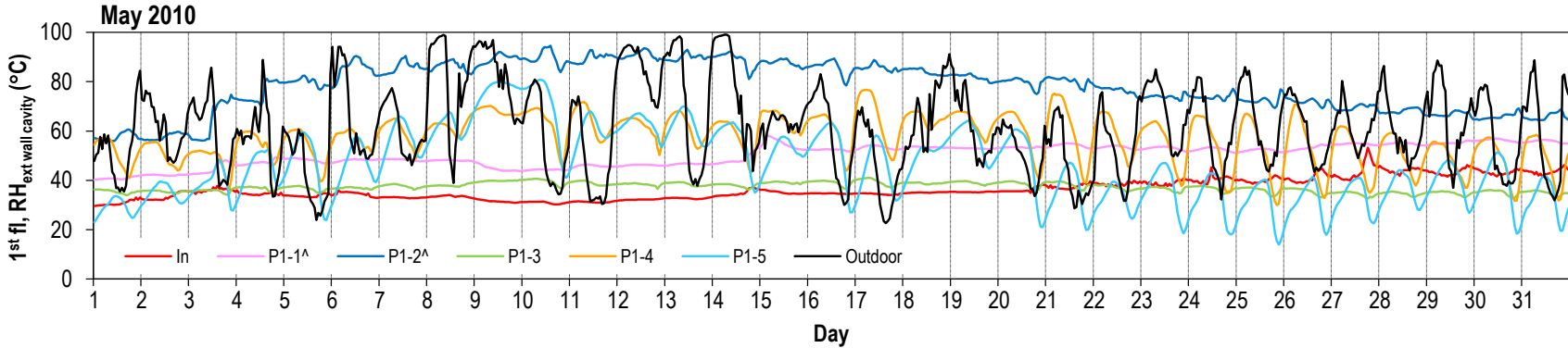
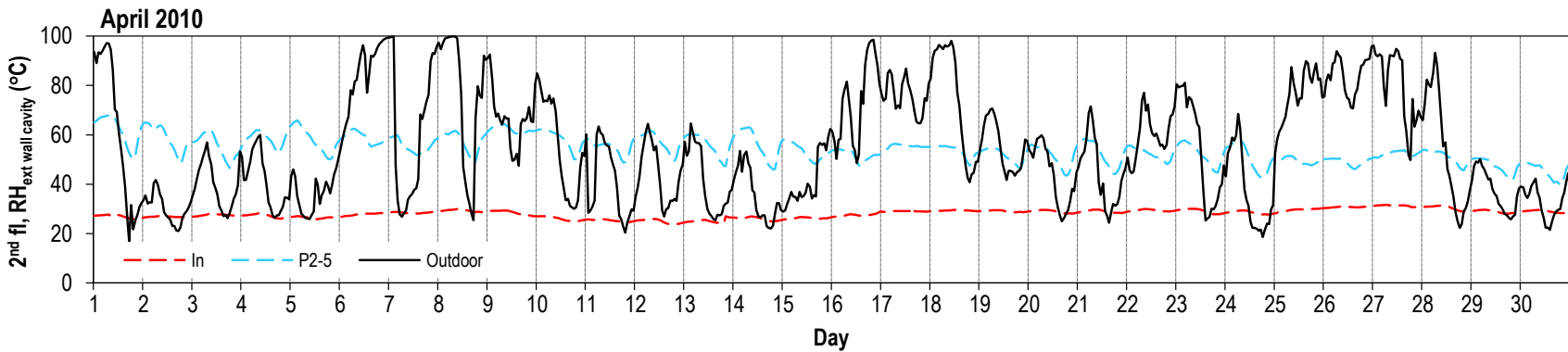

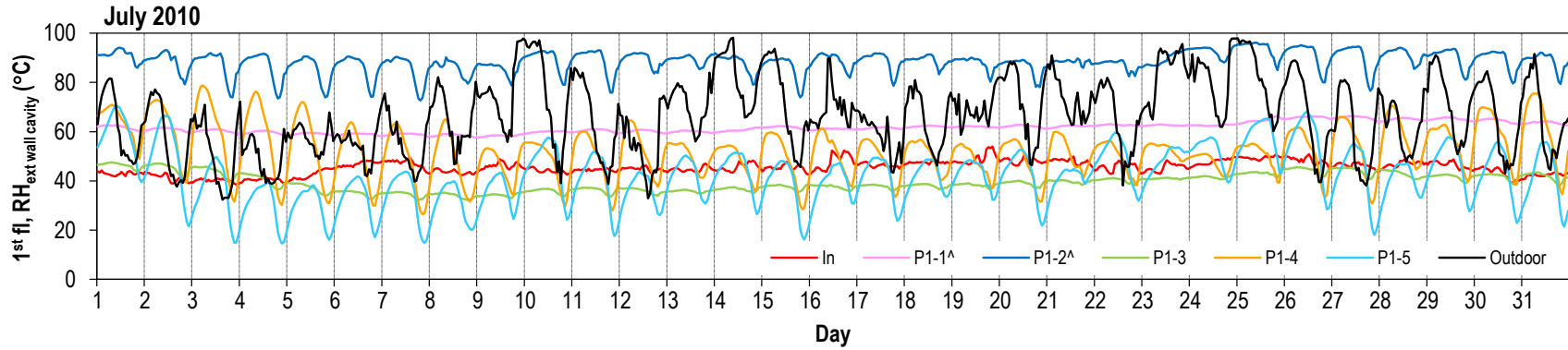
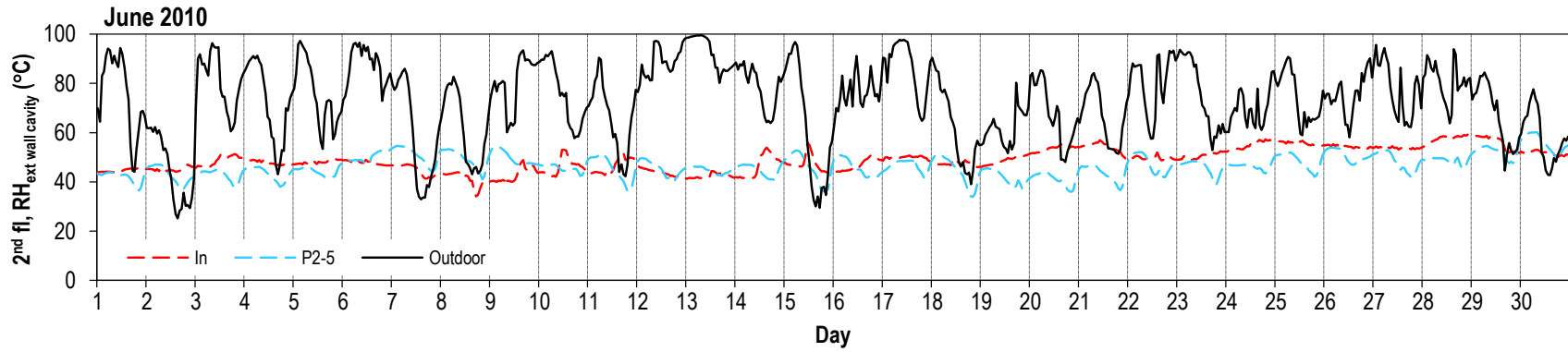
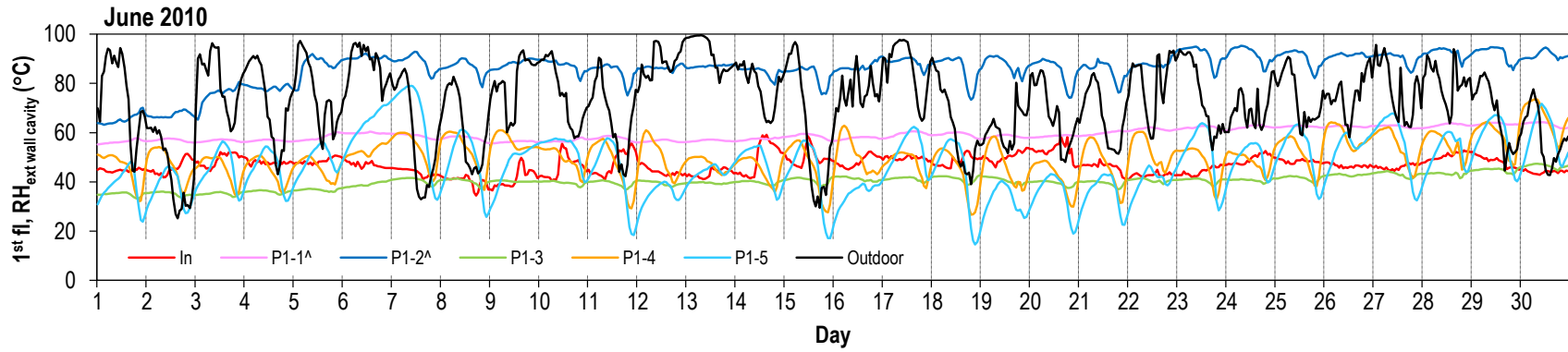

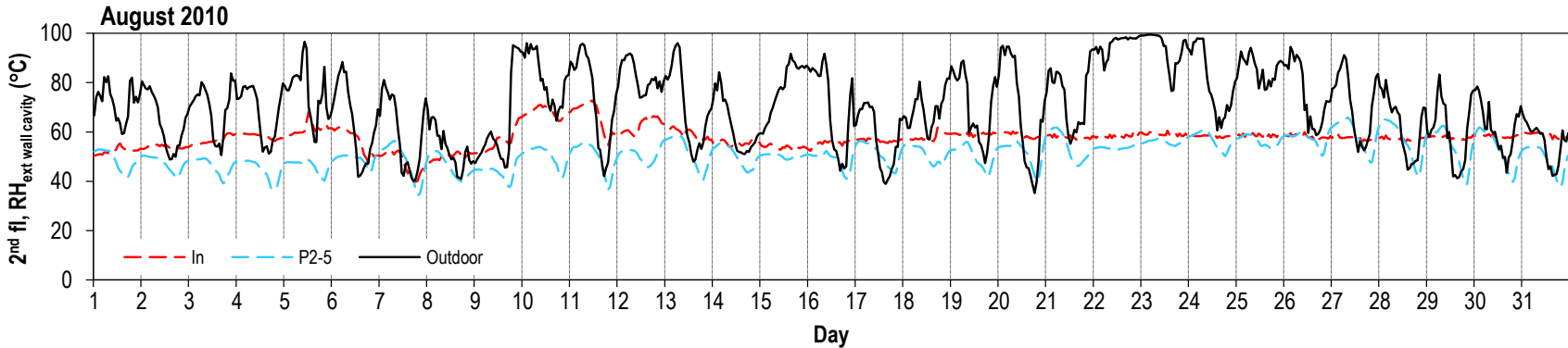
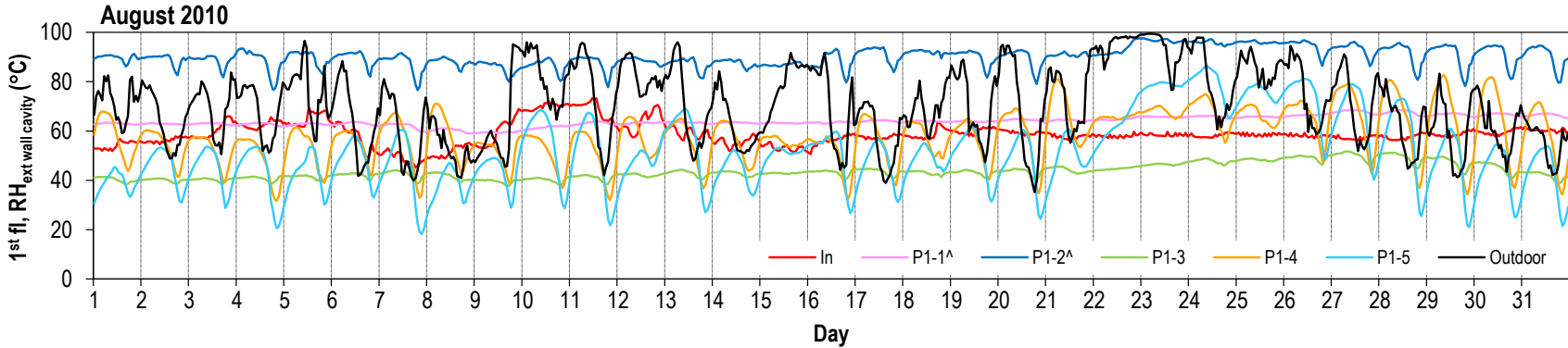
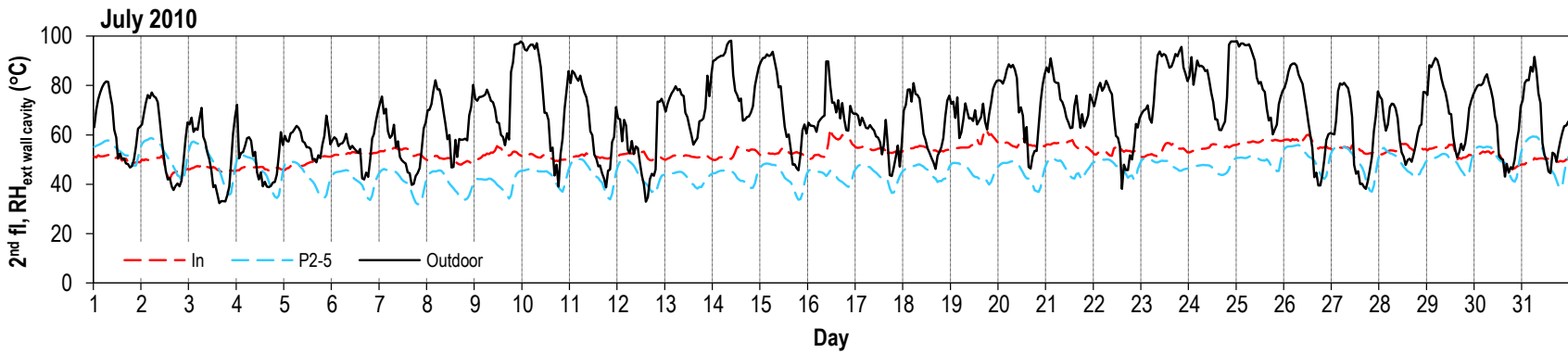

Water vapor pressure (kPa) at exterior side of stud cavity. Refer to Figures 25 thru 28 for sensor location.

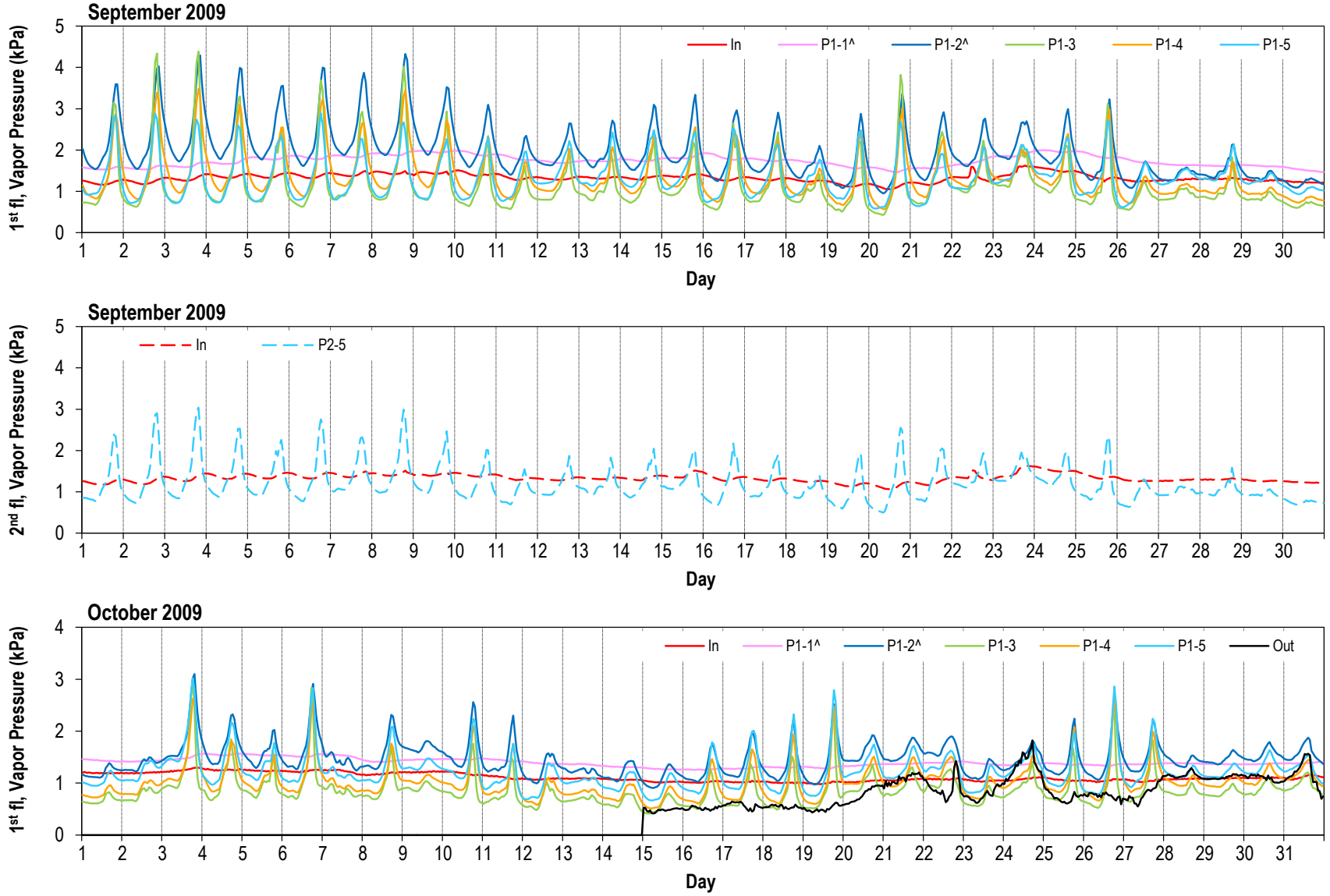

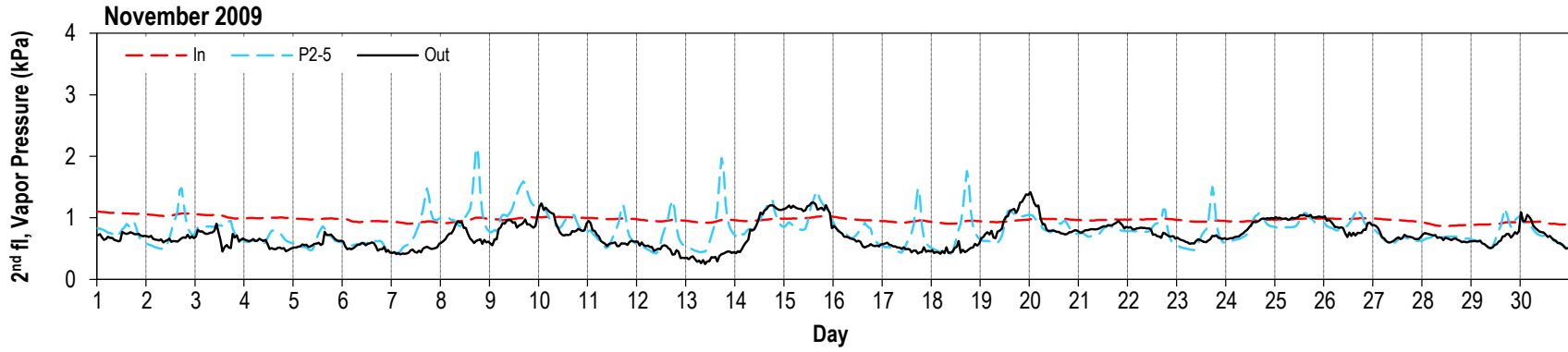
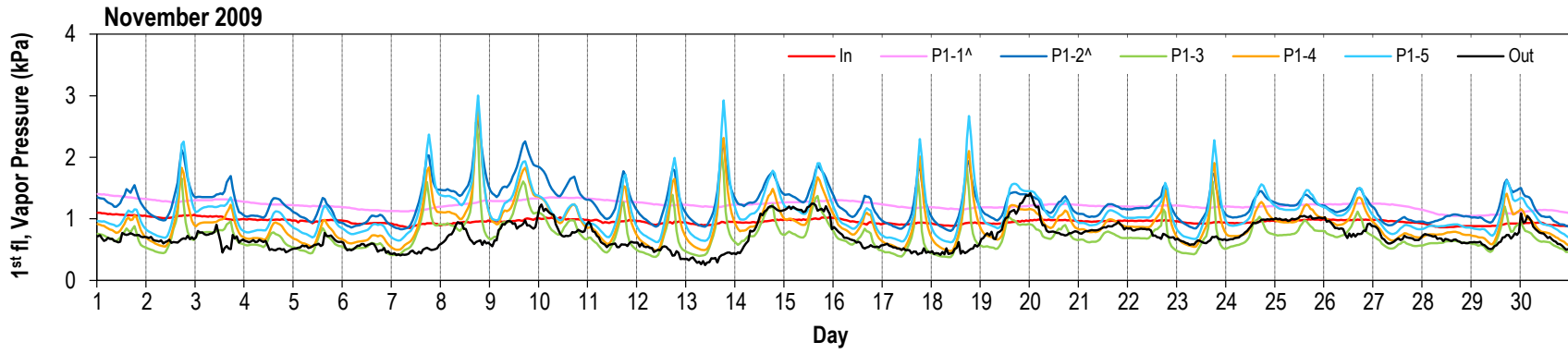
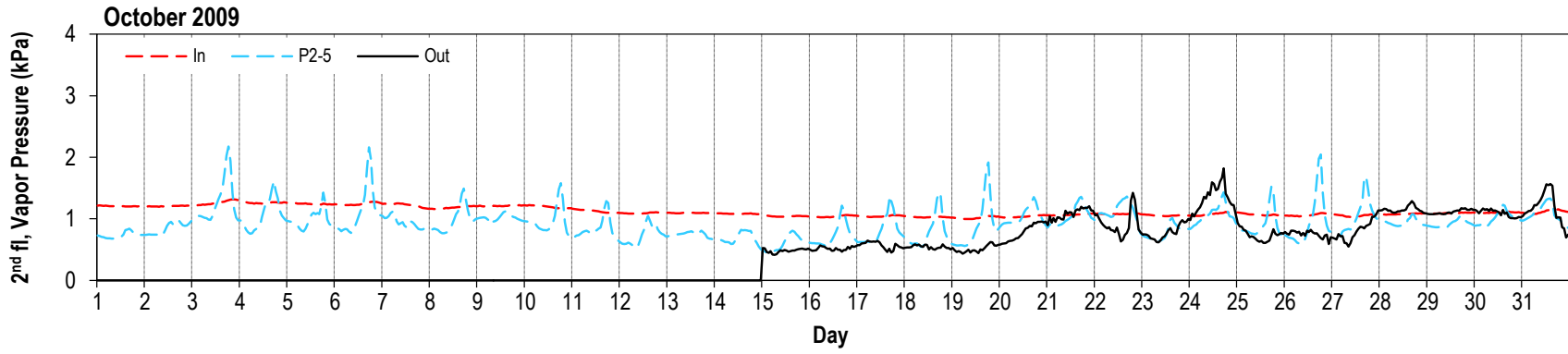

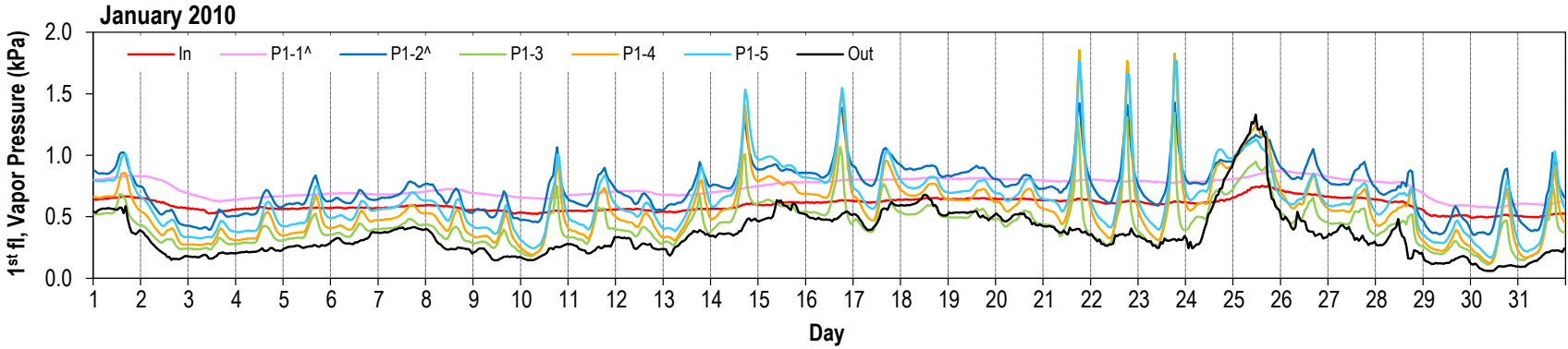
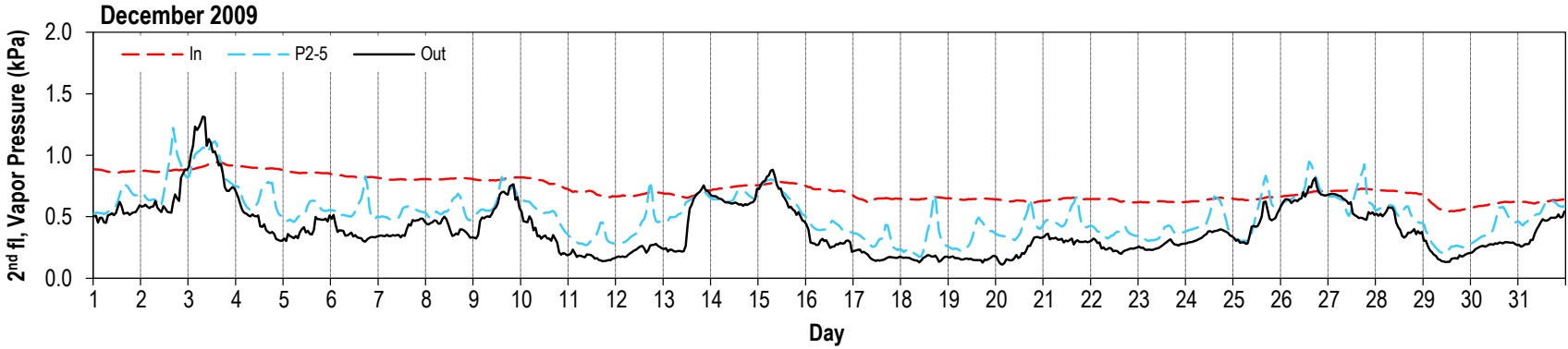
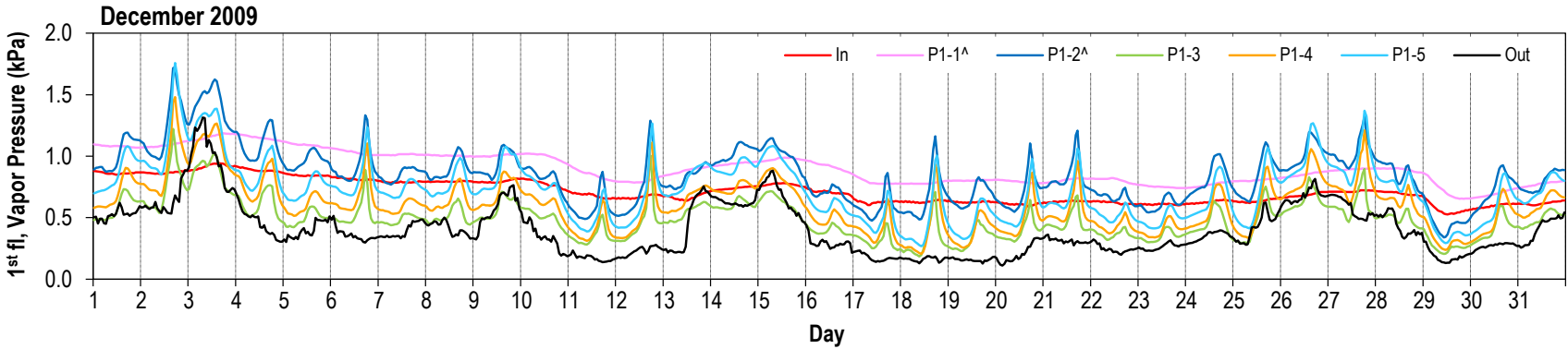

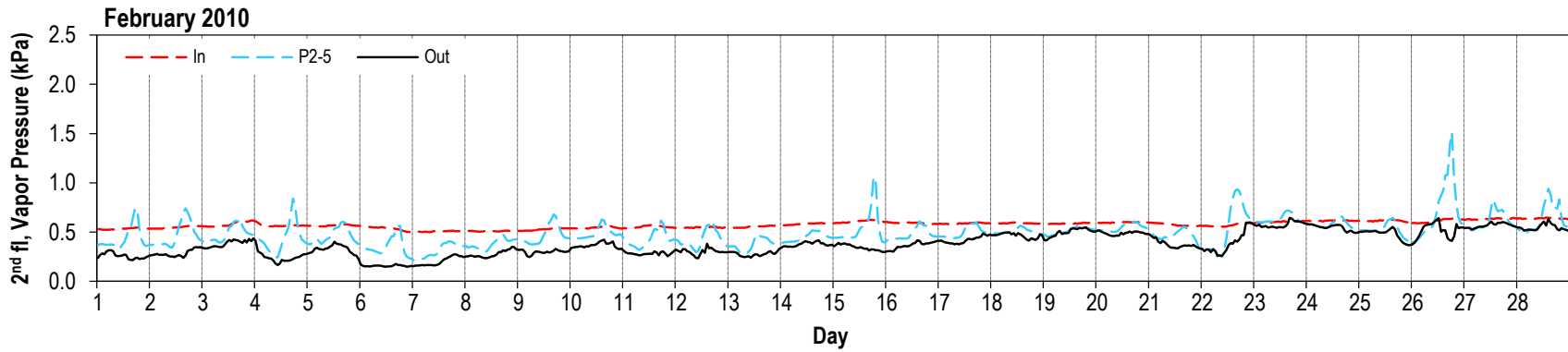
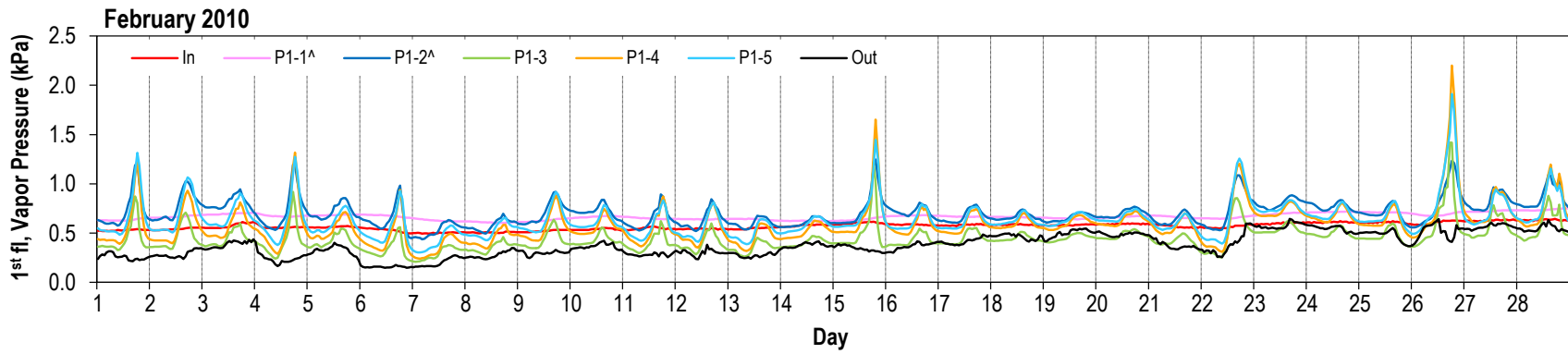
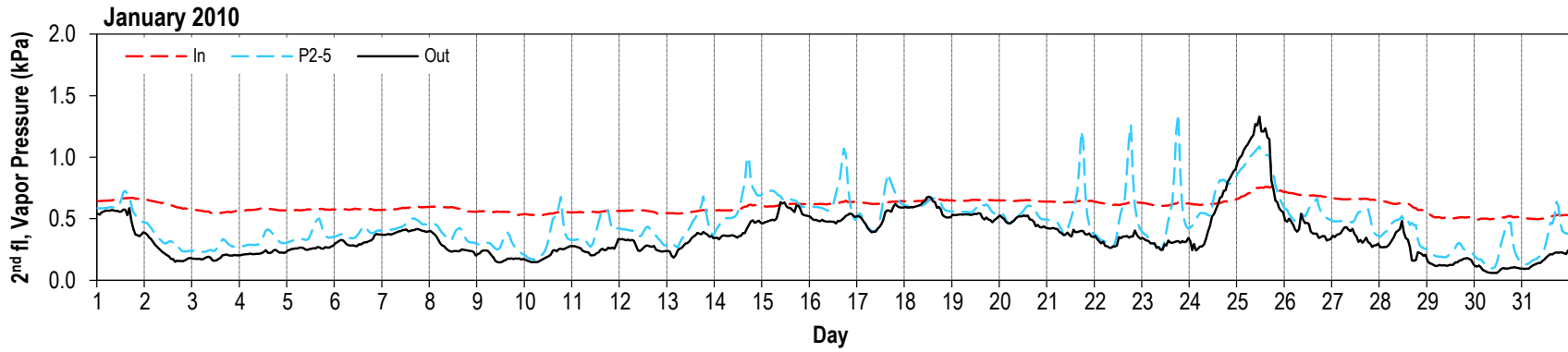

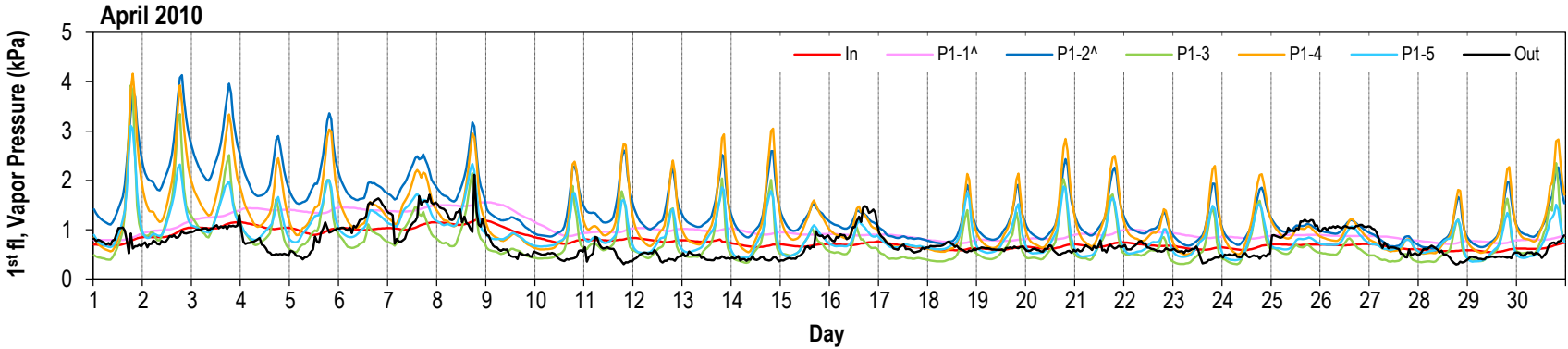
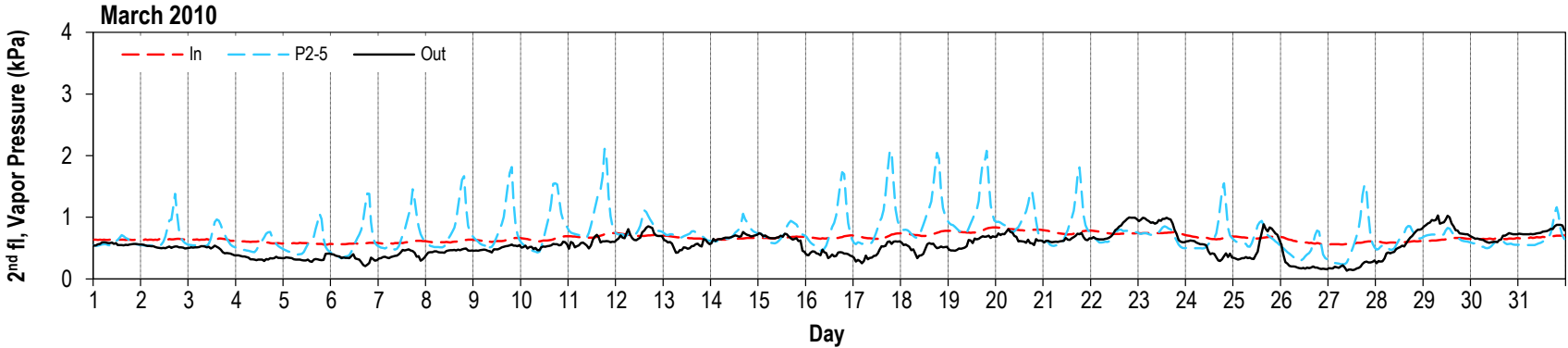
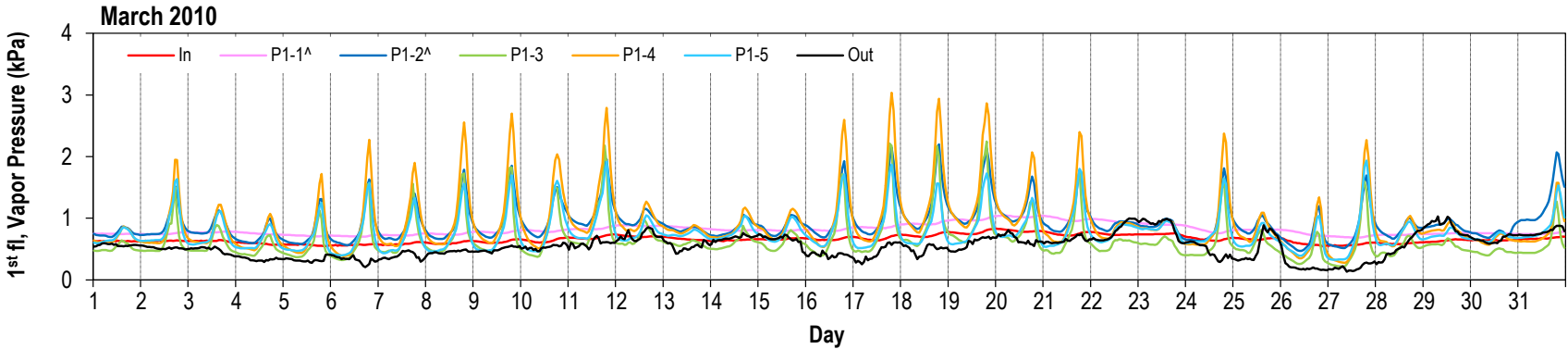

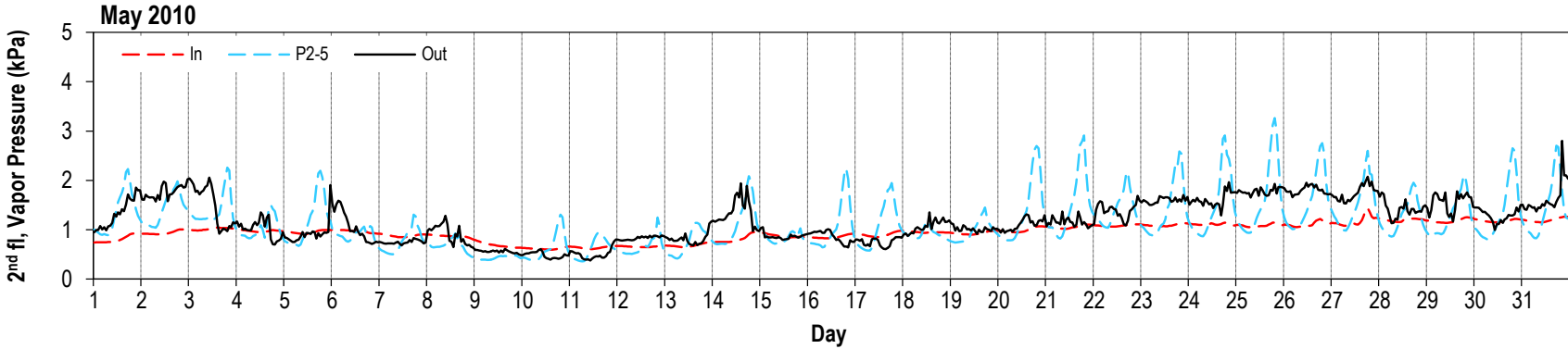
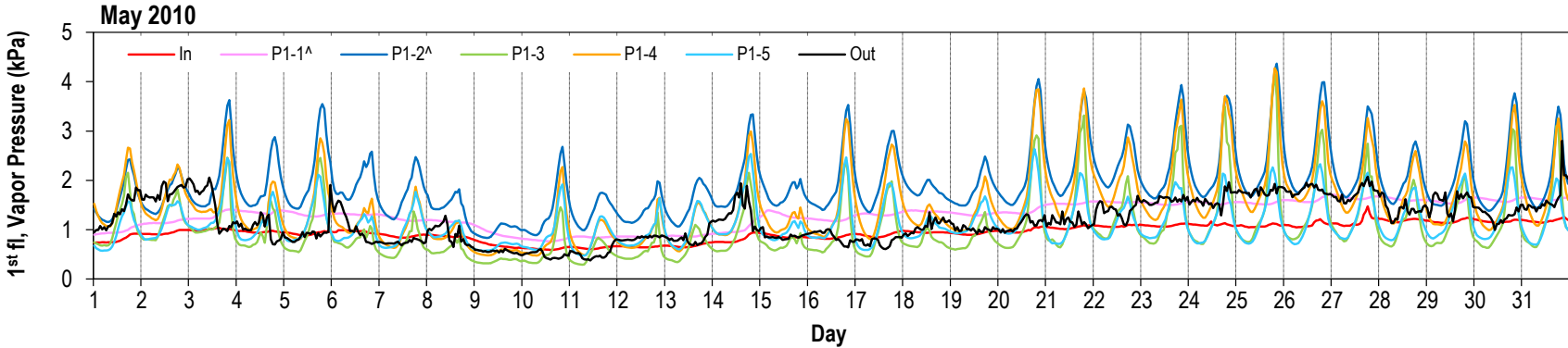
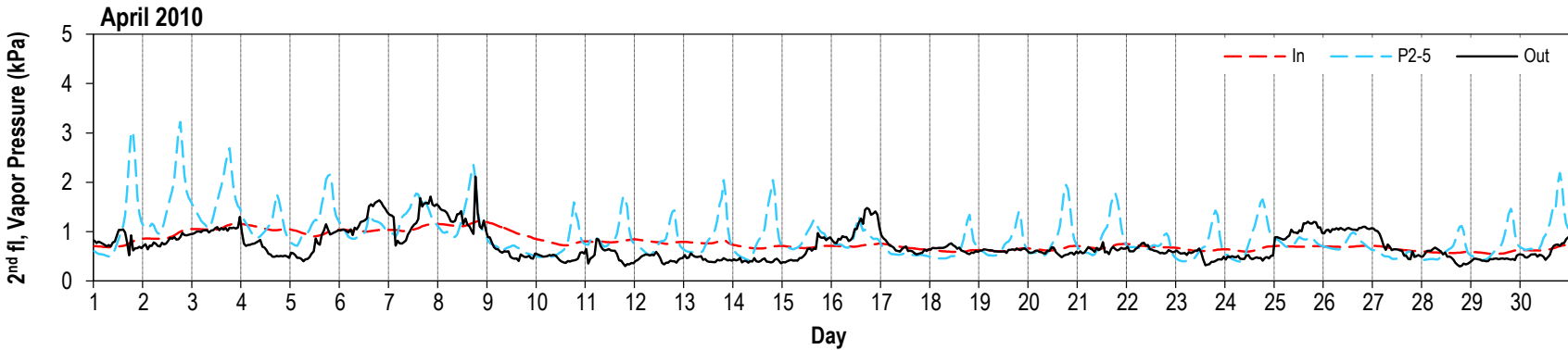

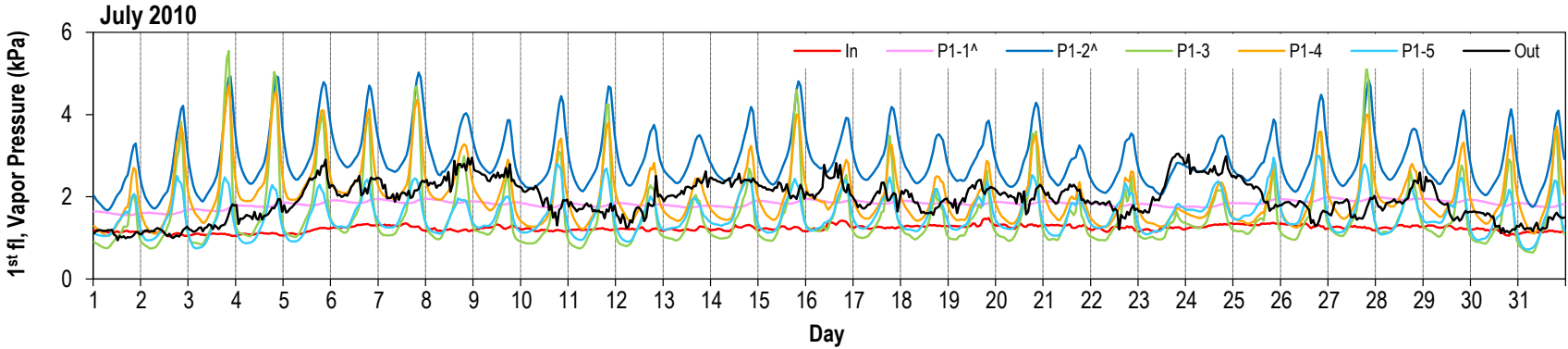
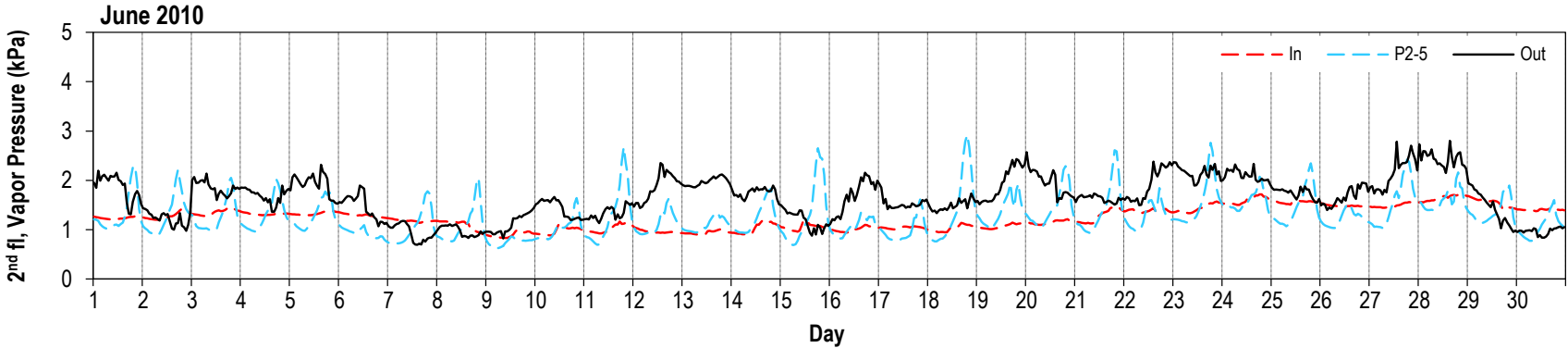
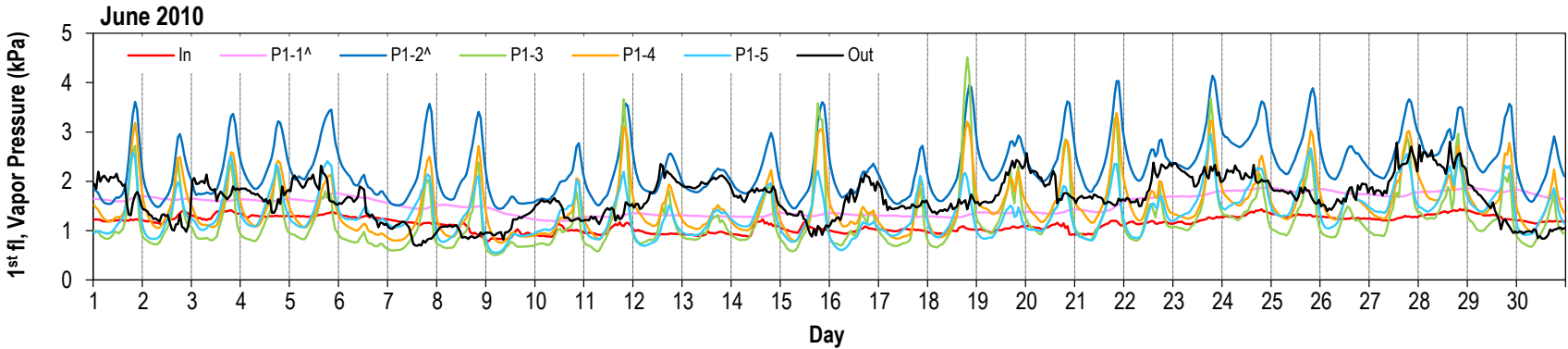

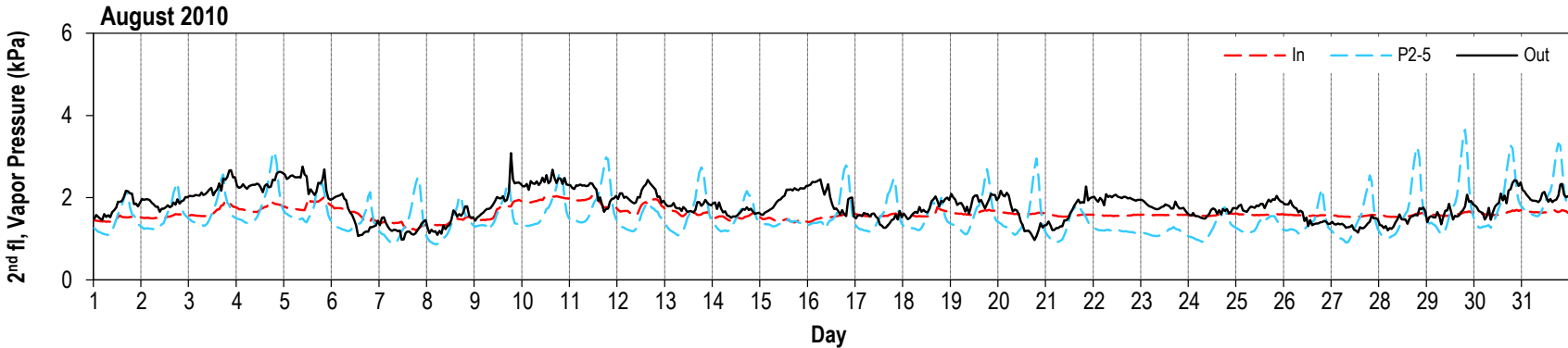
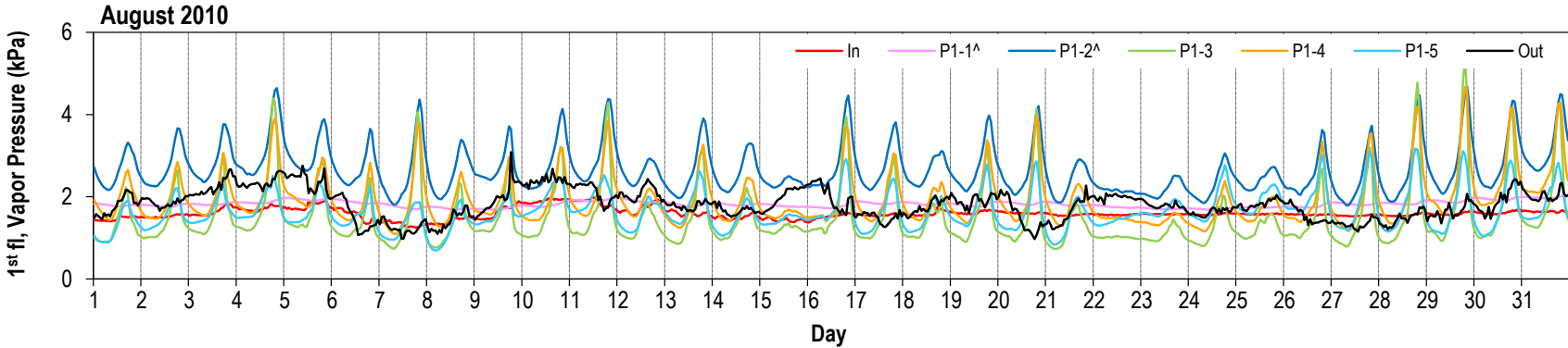
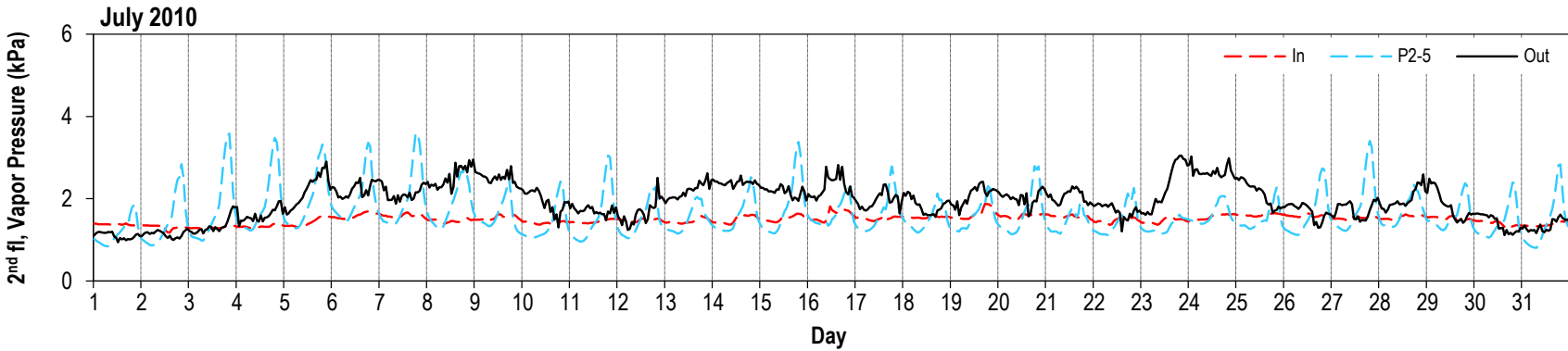

Heat flux (W/m^2) thru interior side of stud cavity. Refer to Figures 25 thru 28 for sensor location.

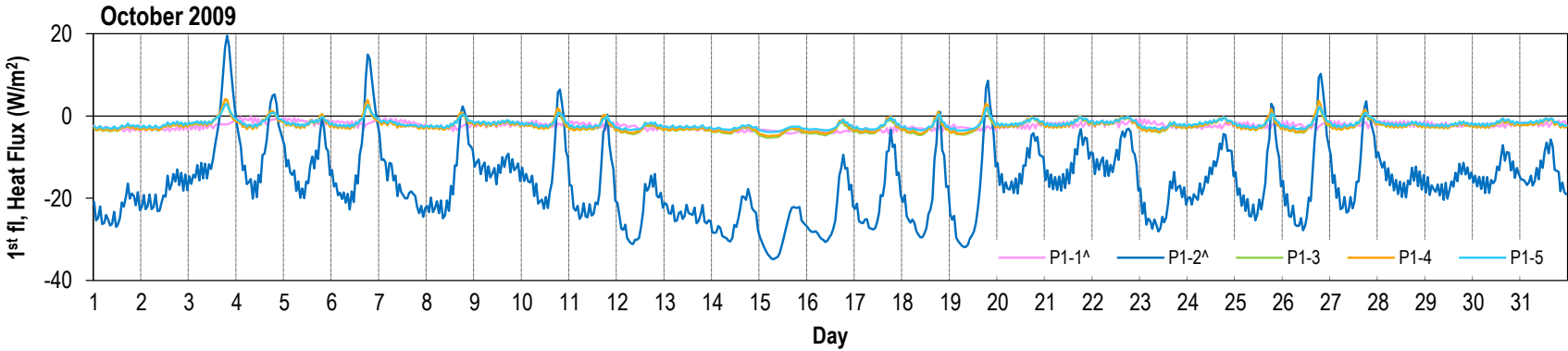
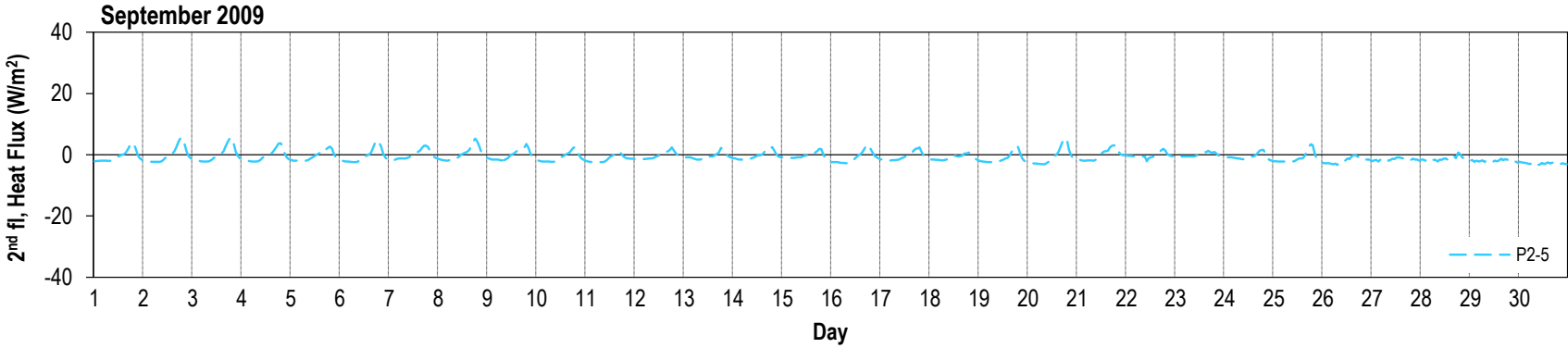
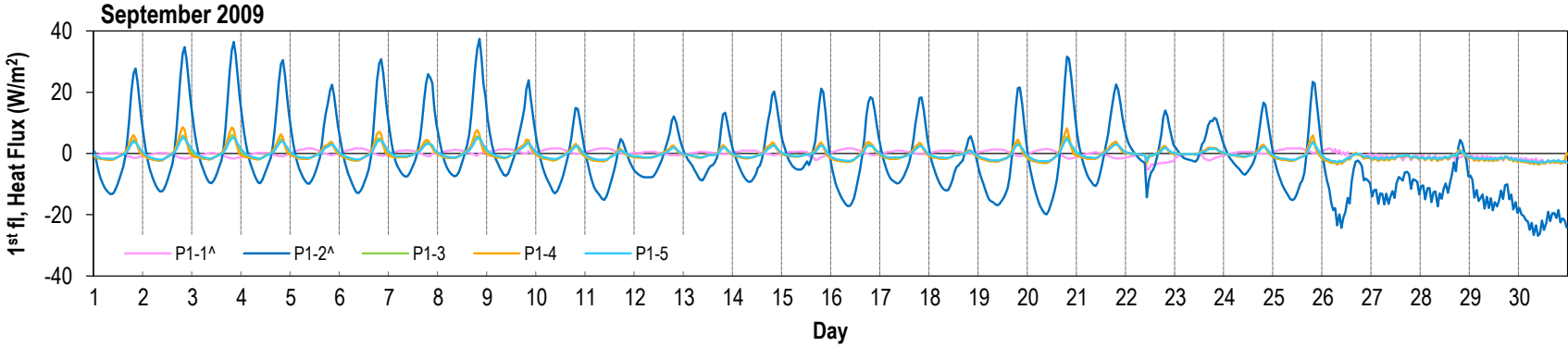

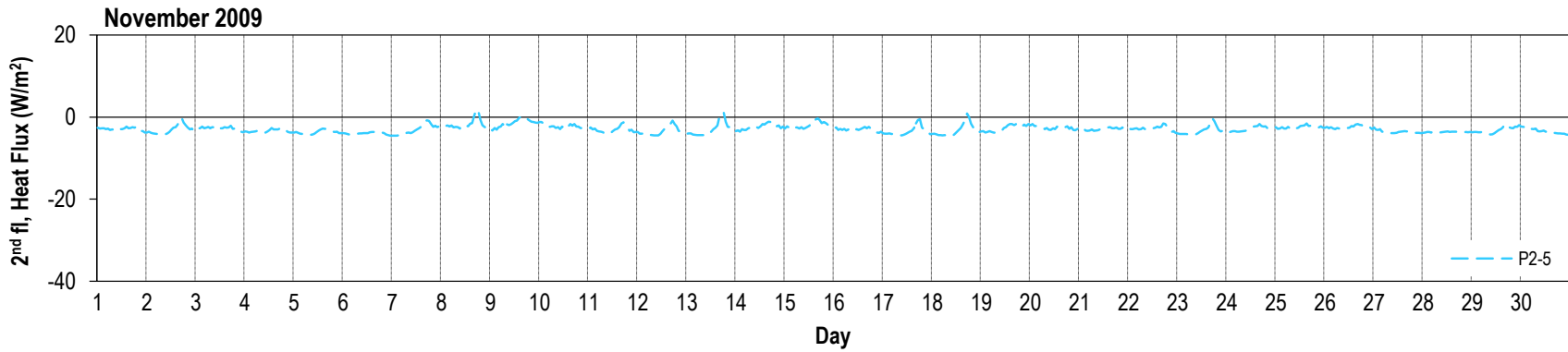
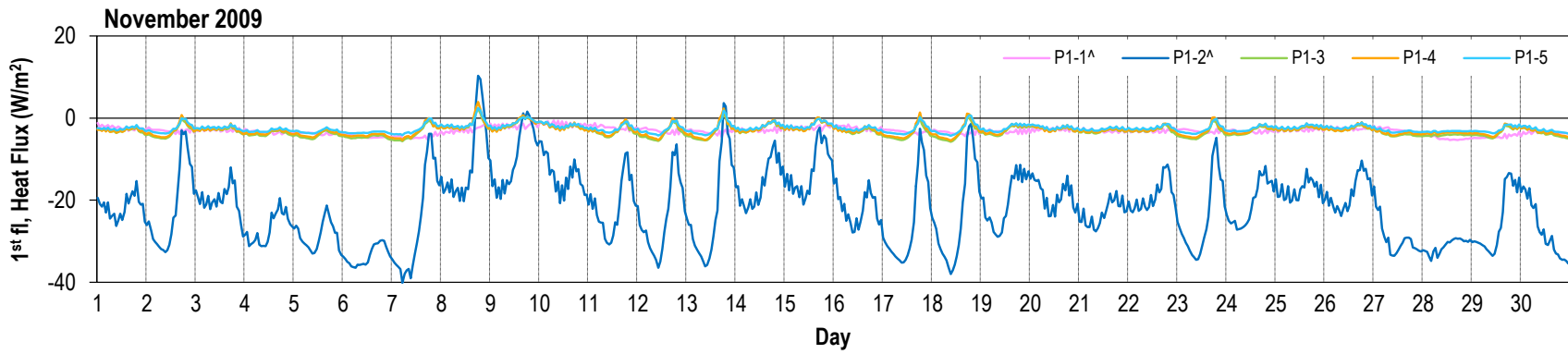
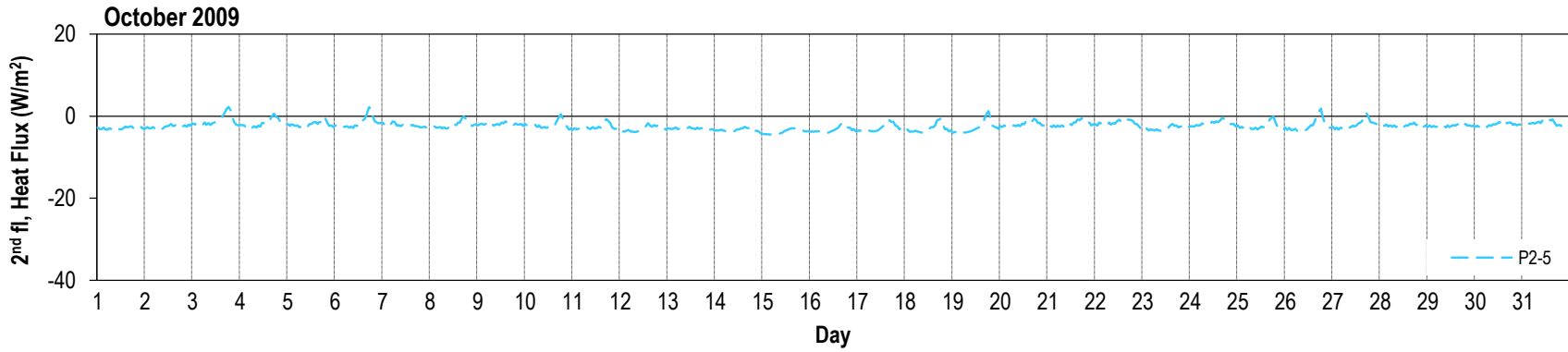

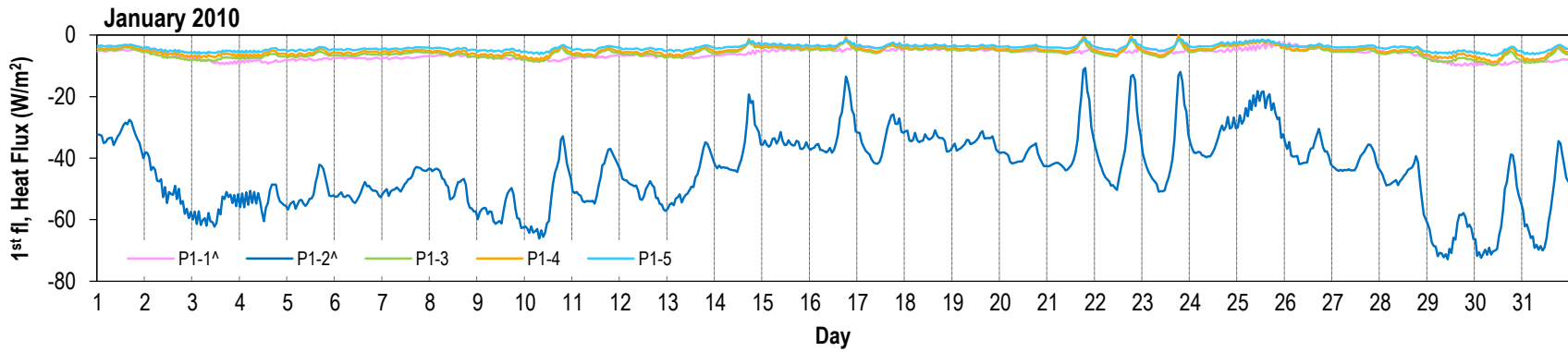
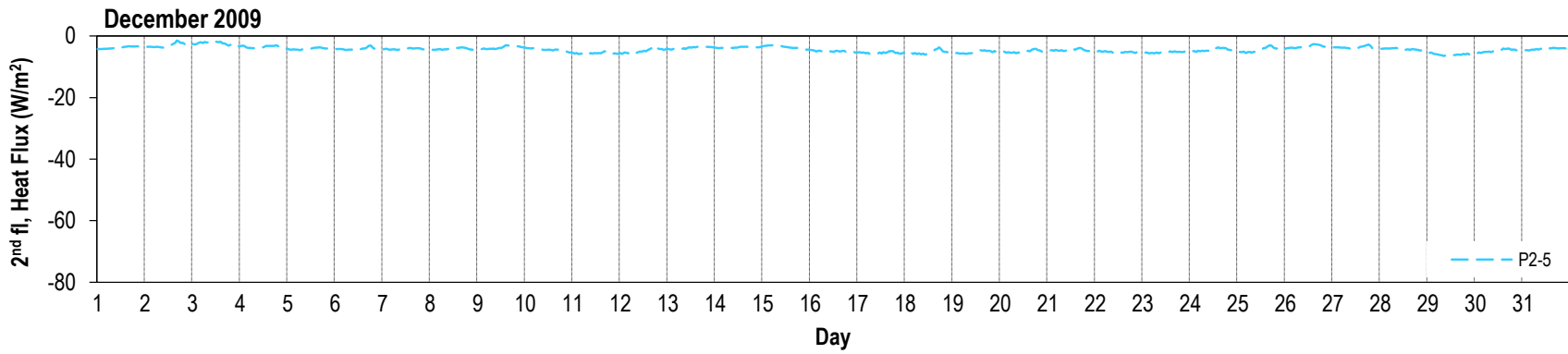
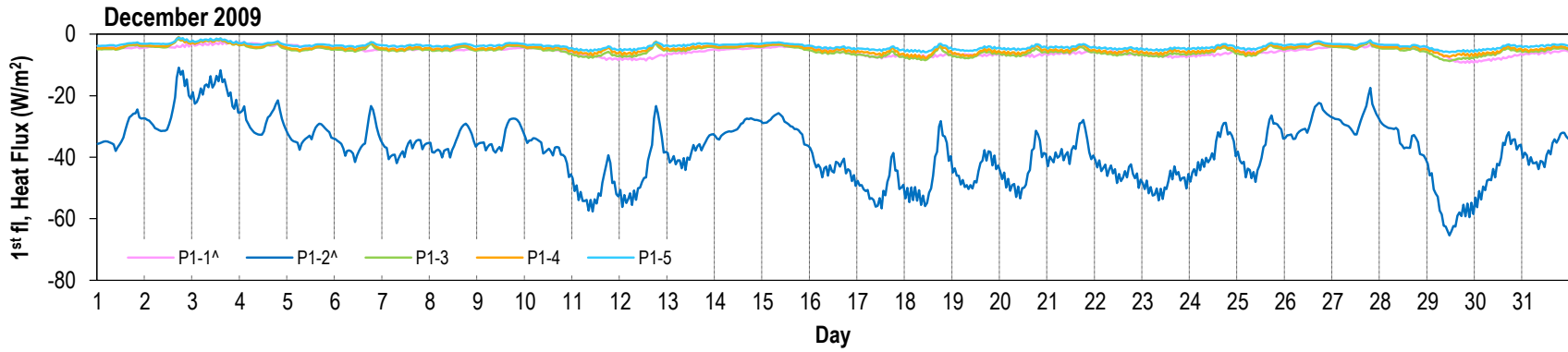

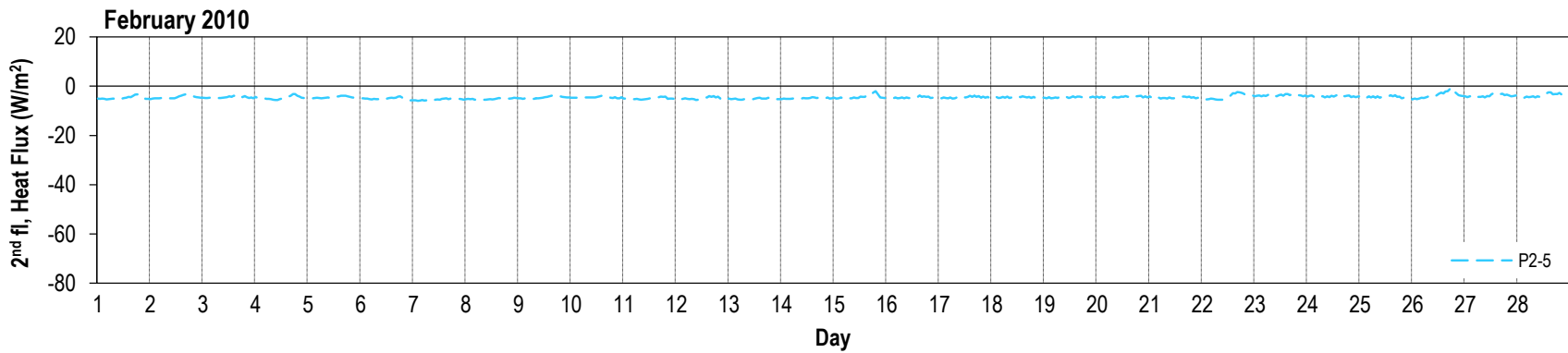
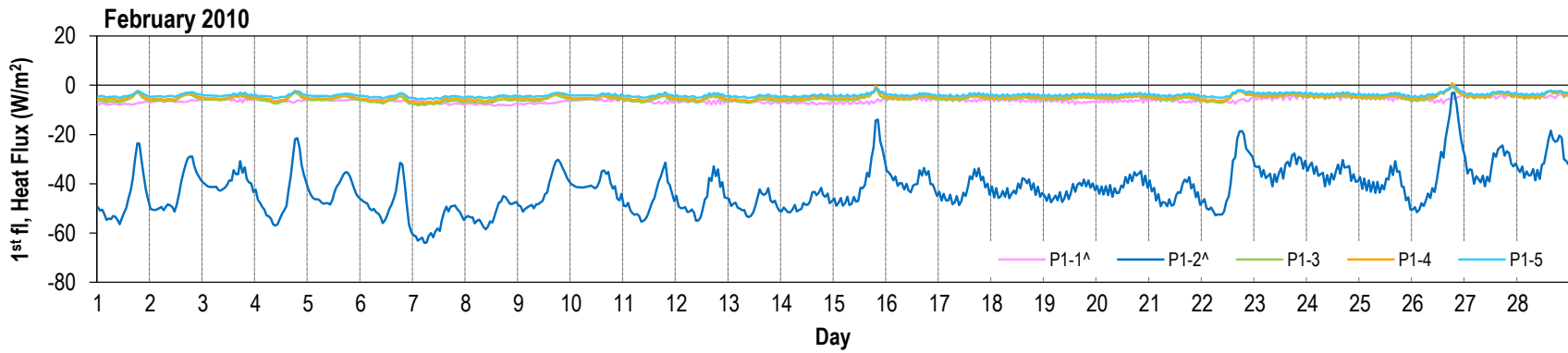
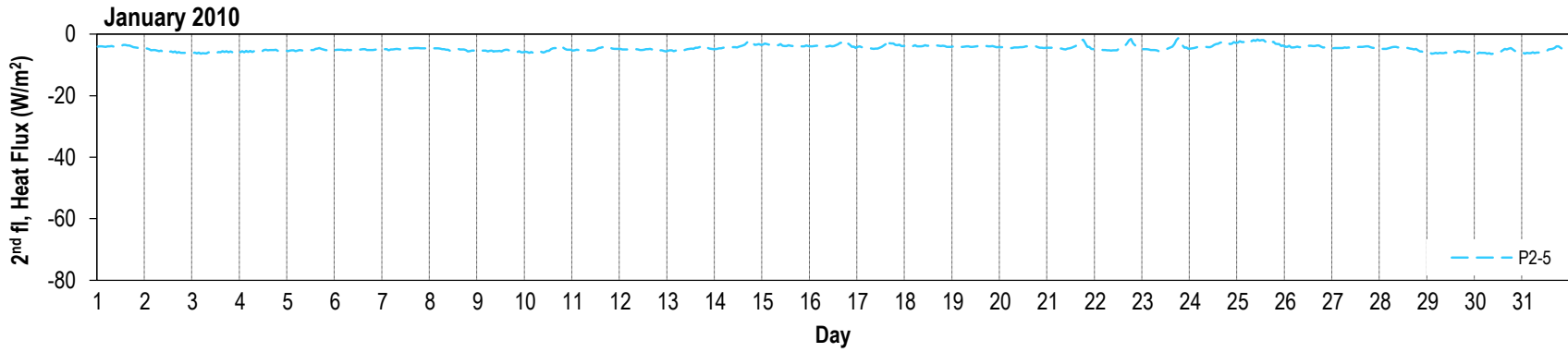

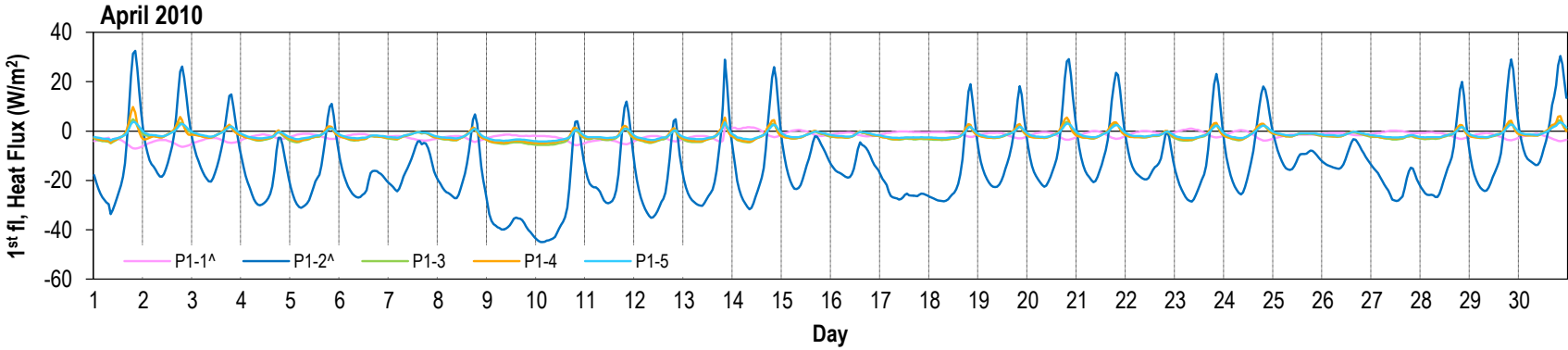
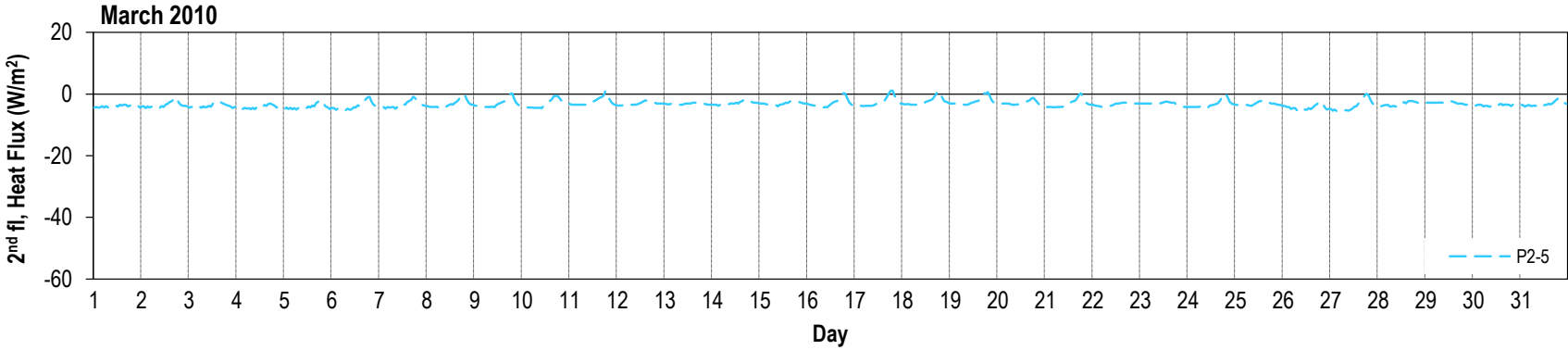
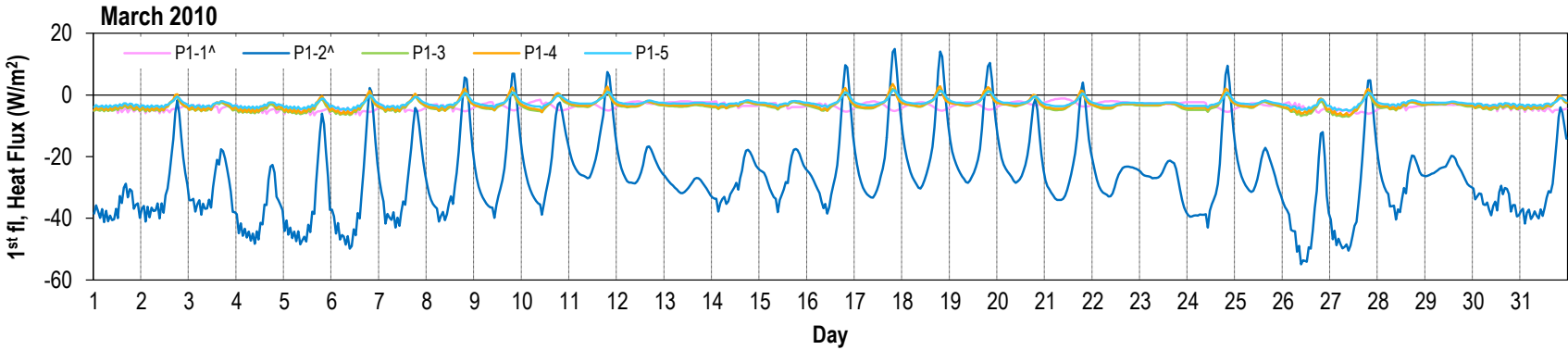

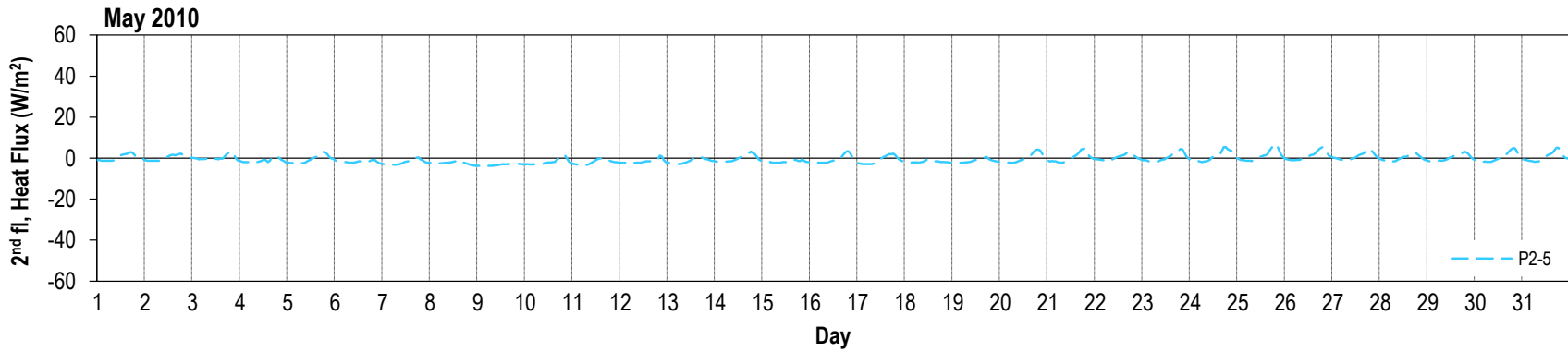
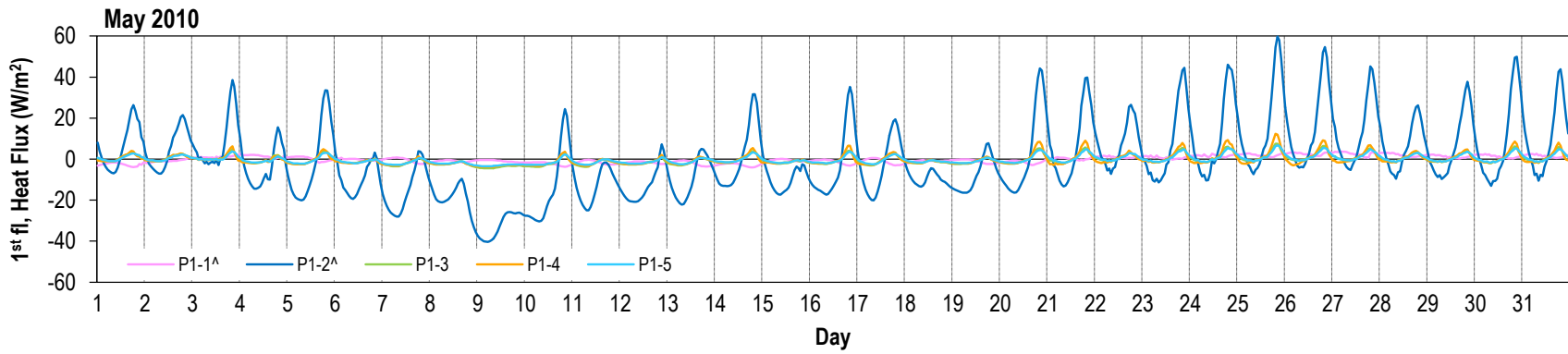
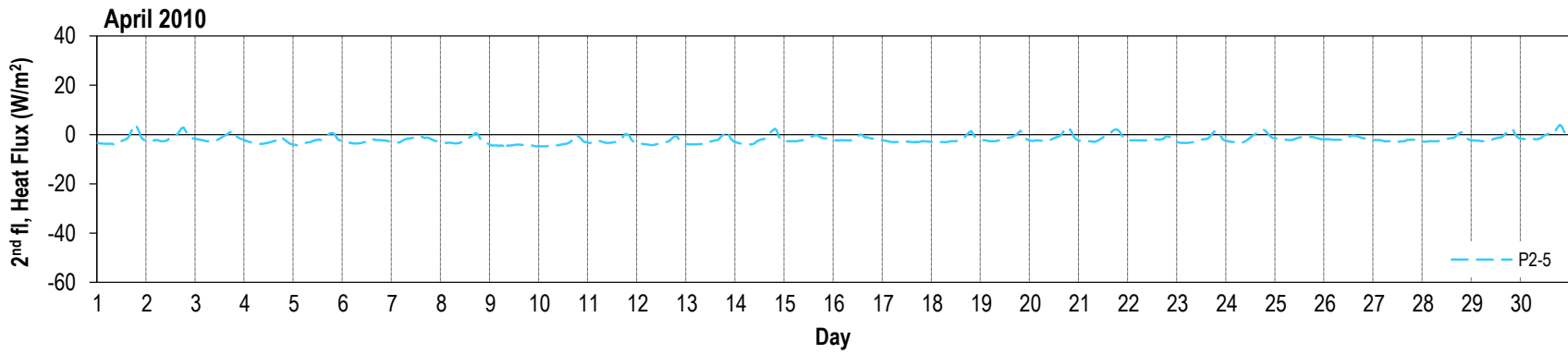

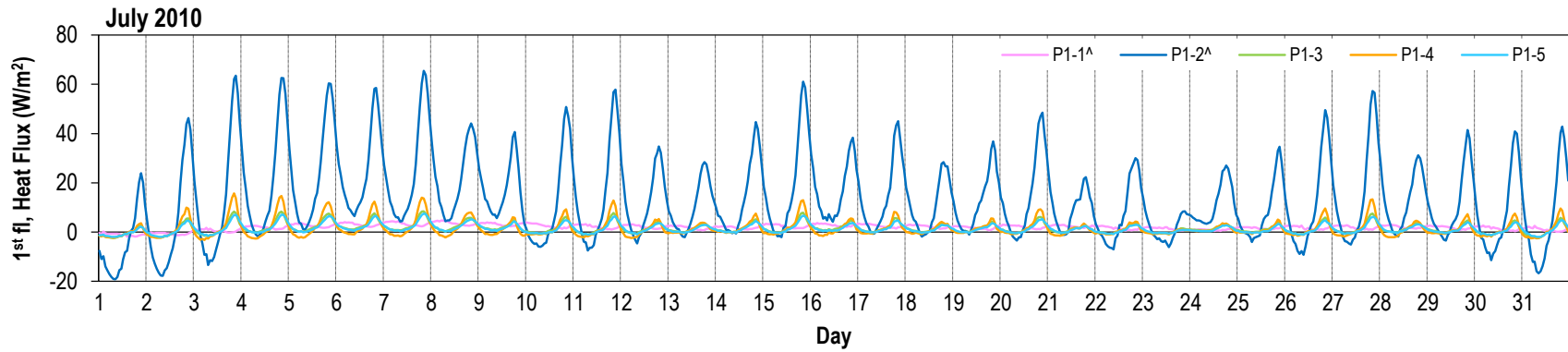
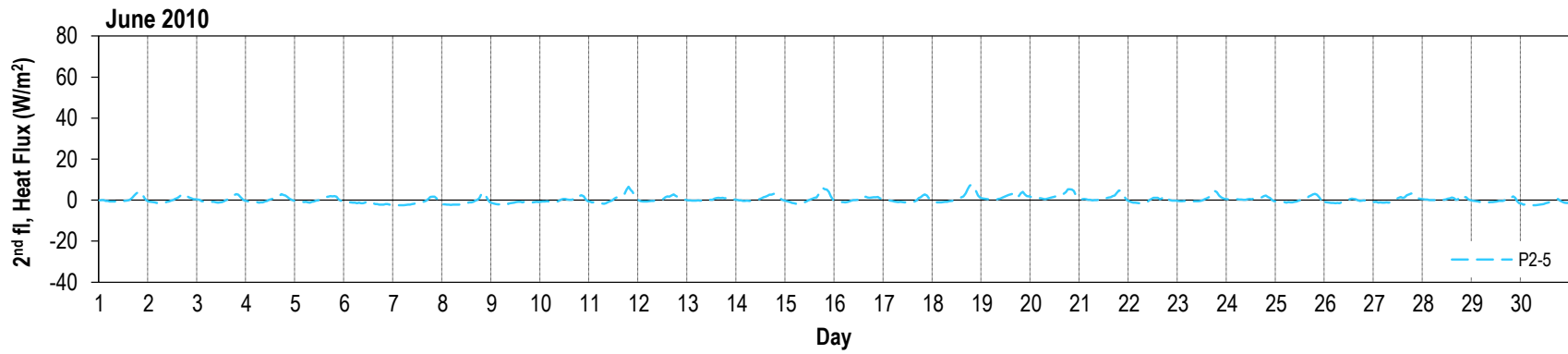
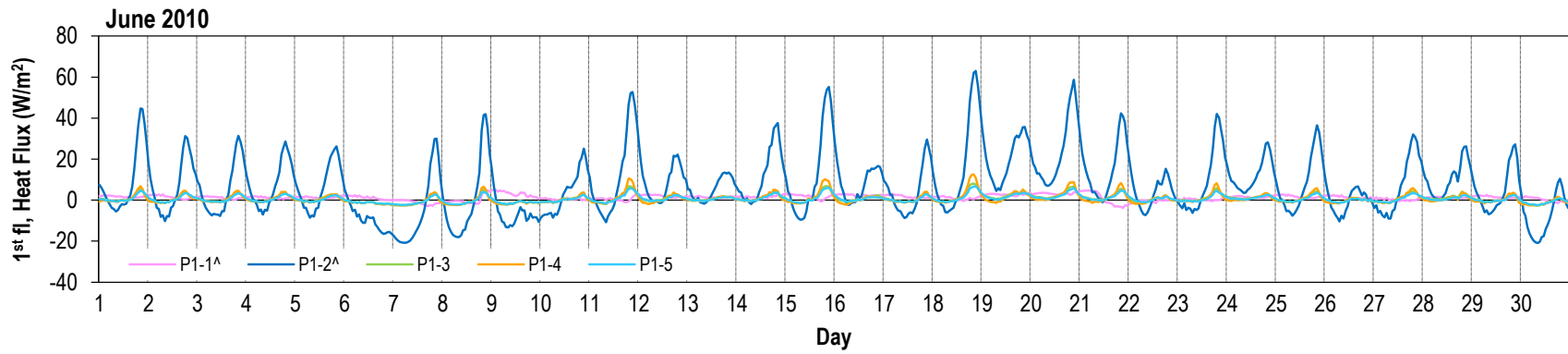

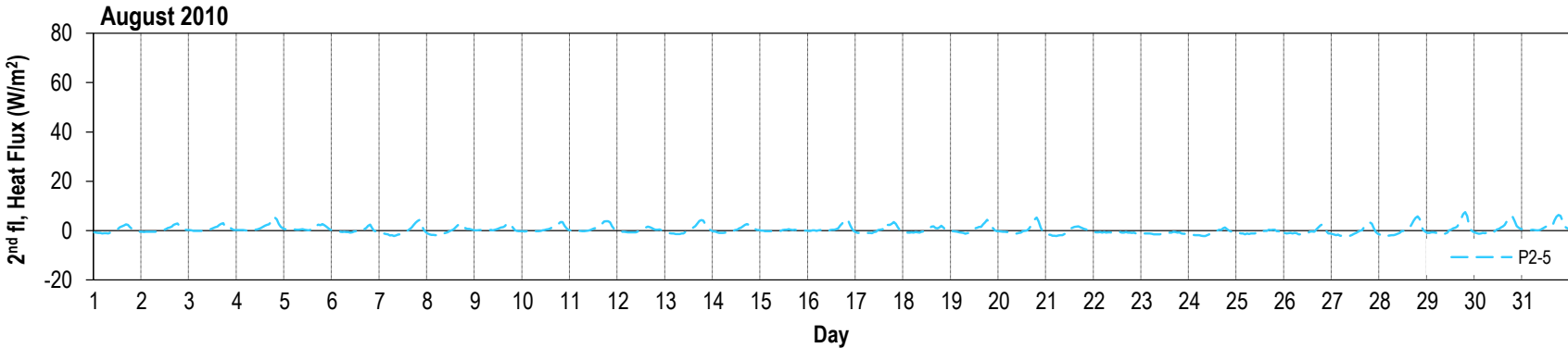
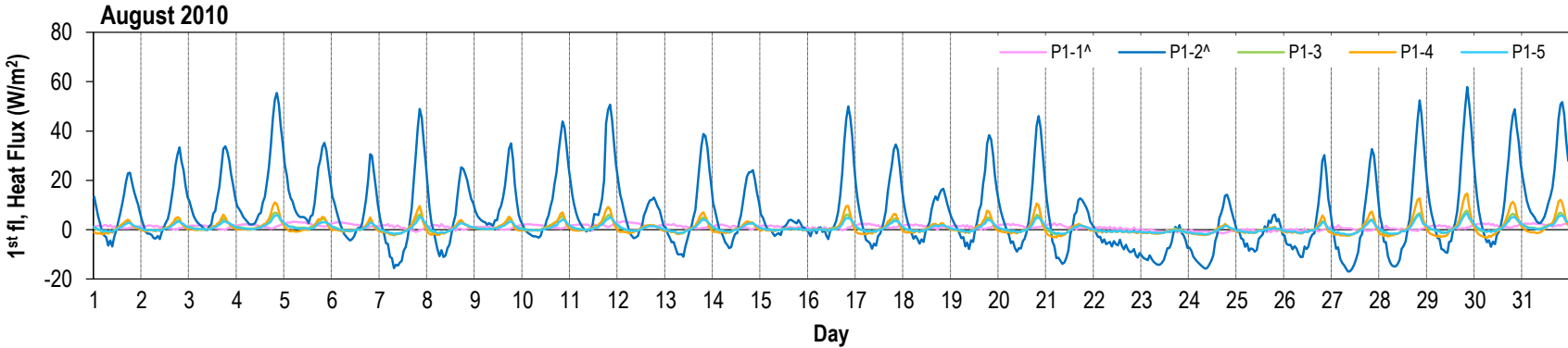
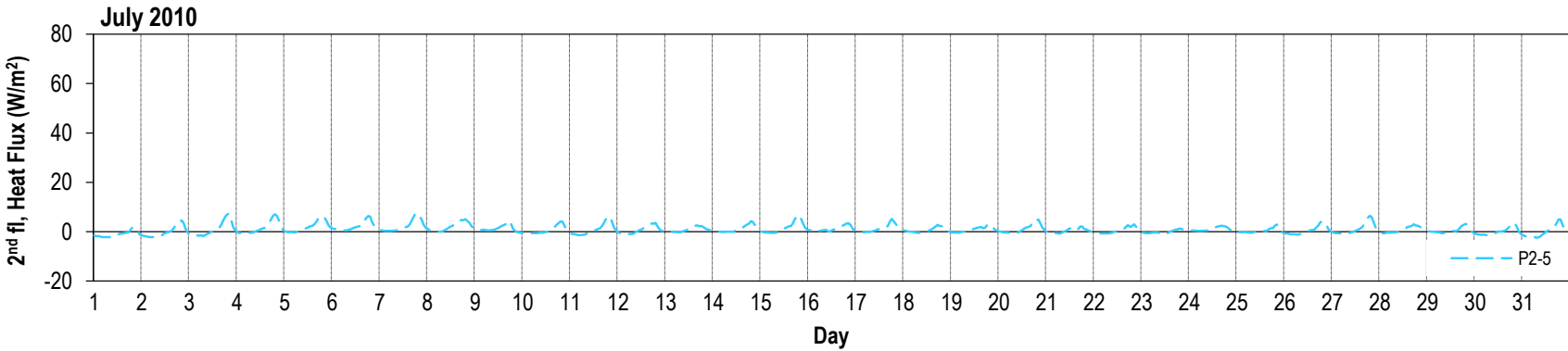

Cooling loads (Wh/m²). Refer to Figures 25 thru 28 for sensor location.

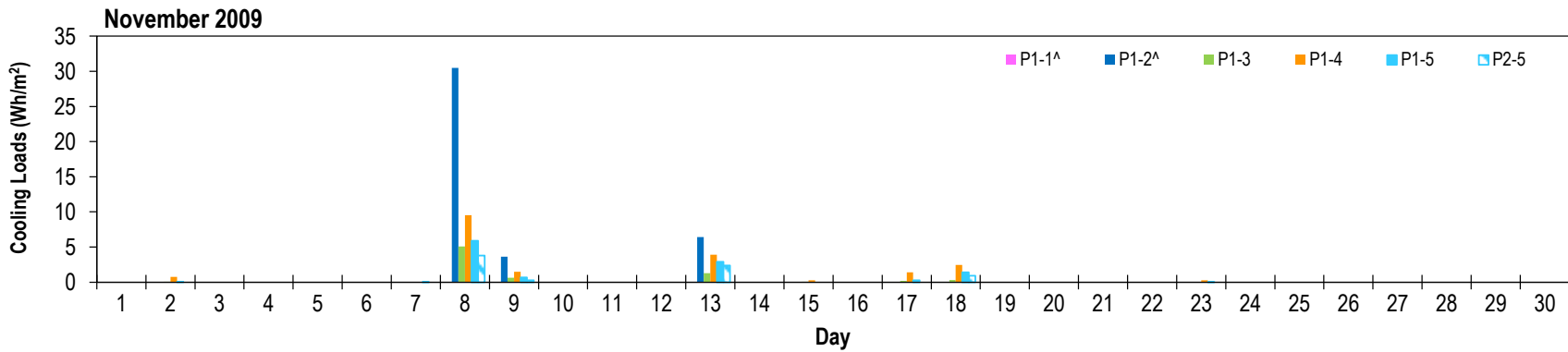
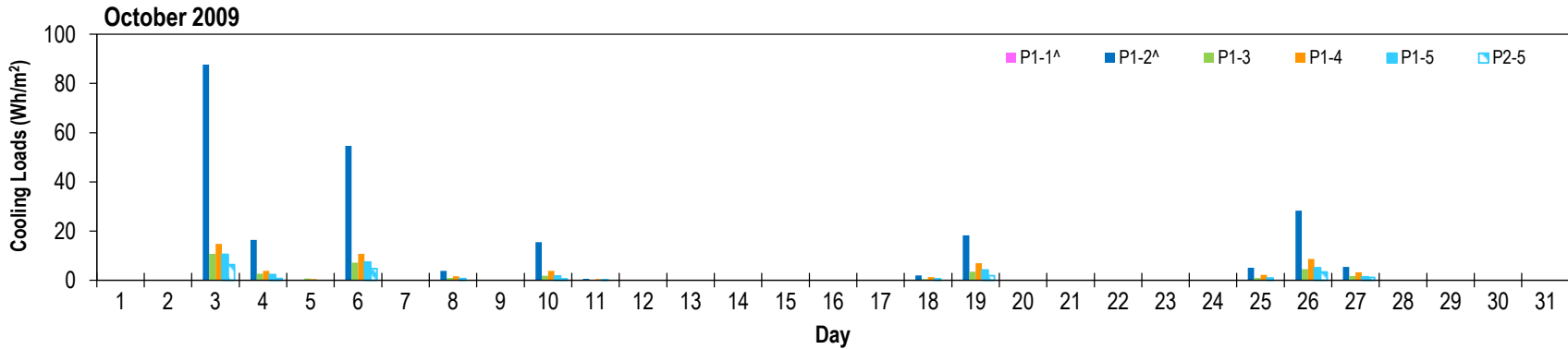
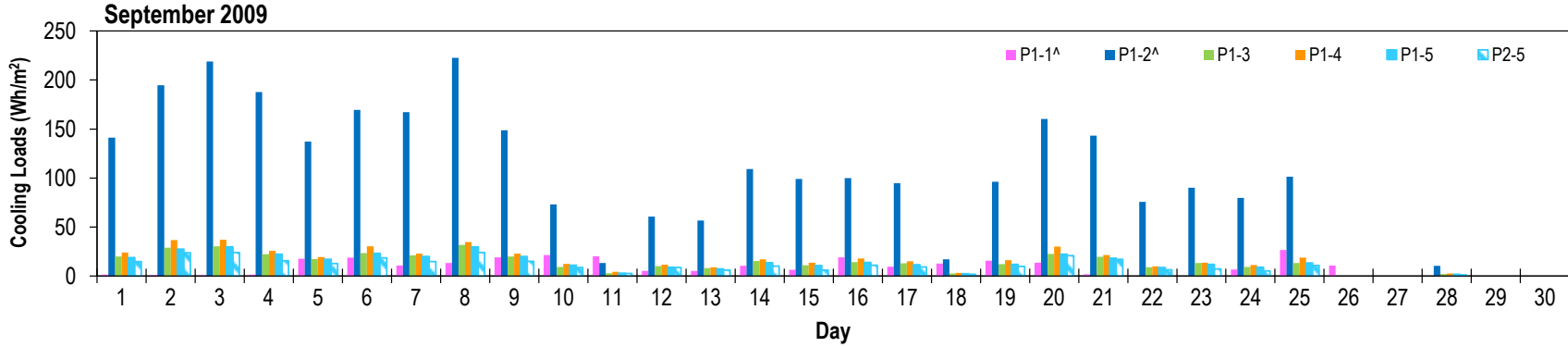

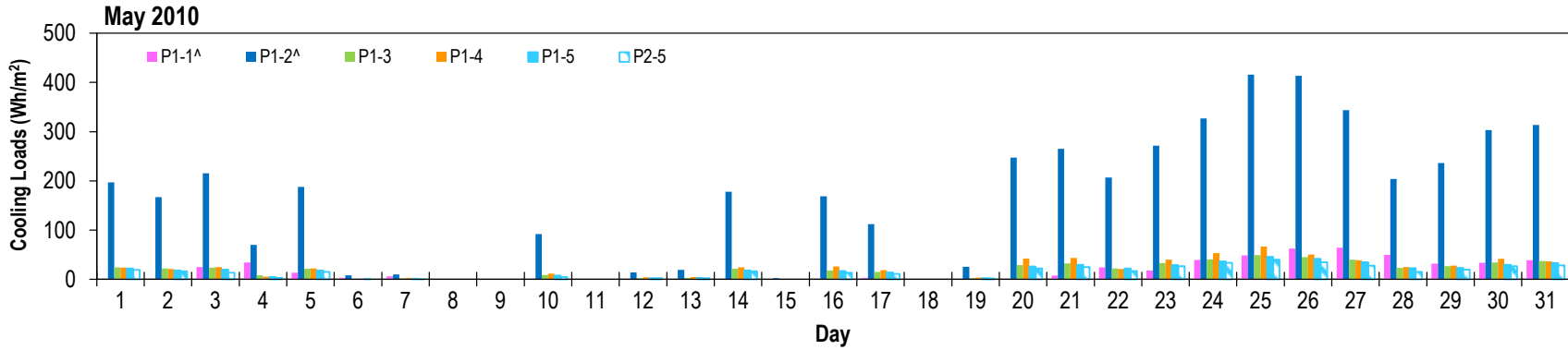
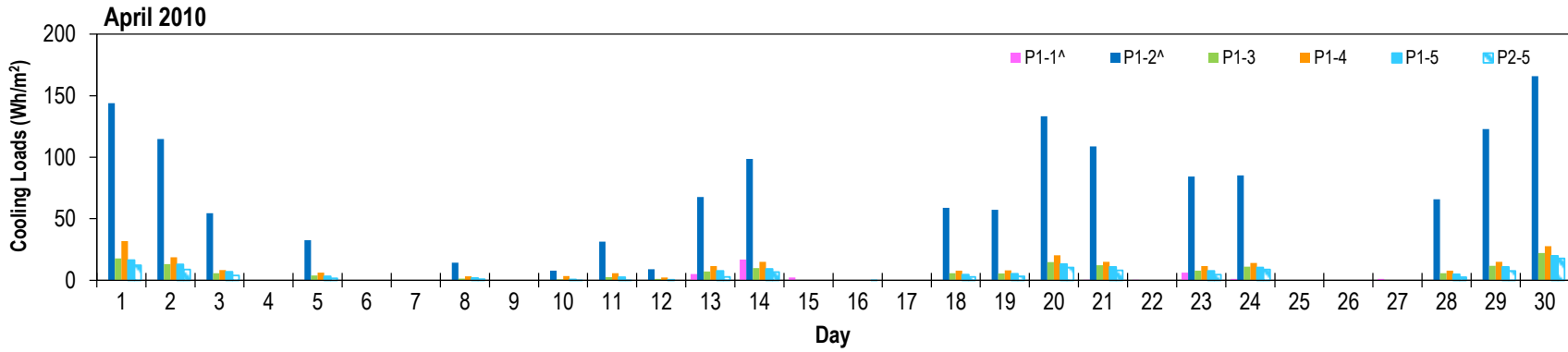
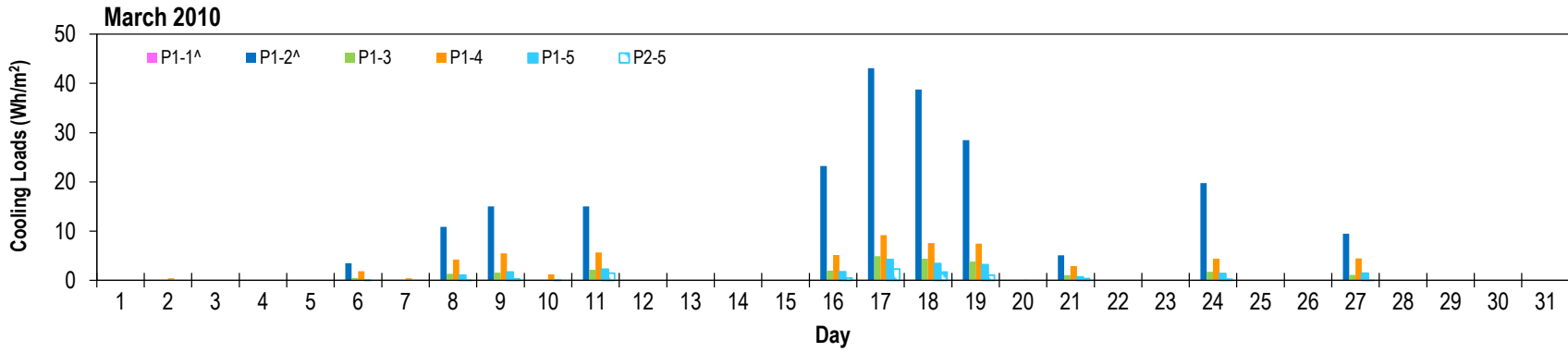

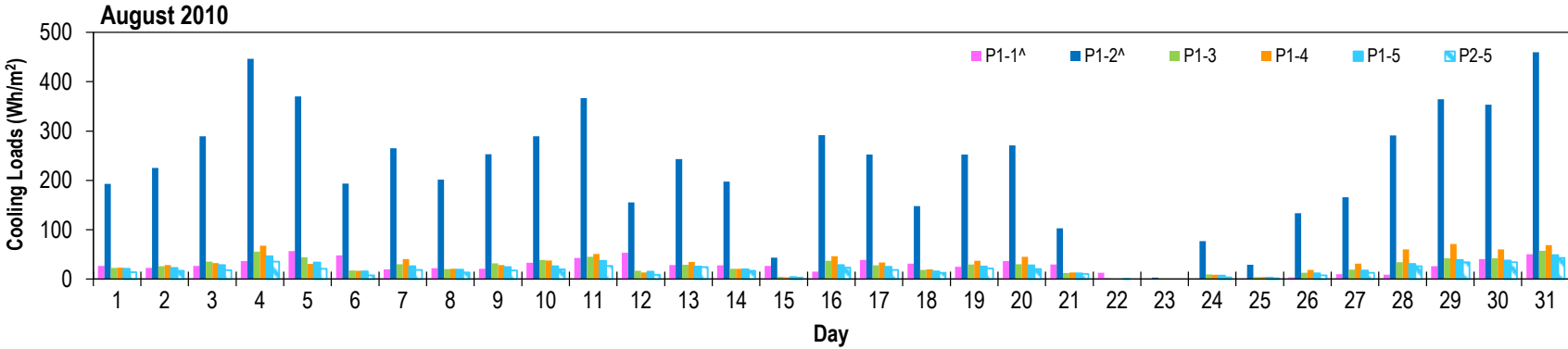
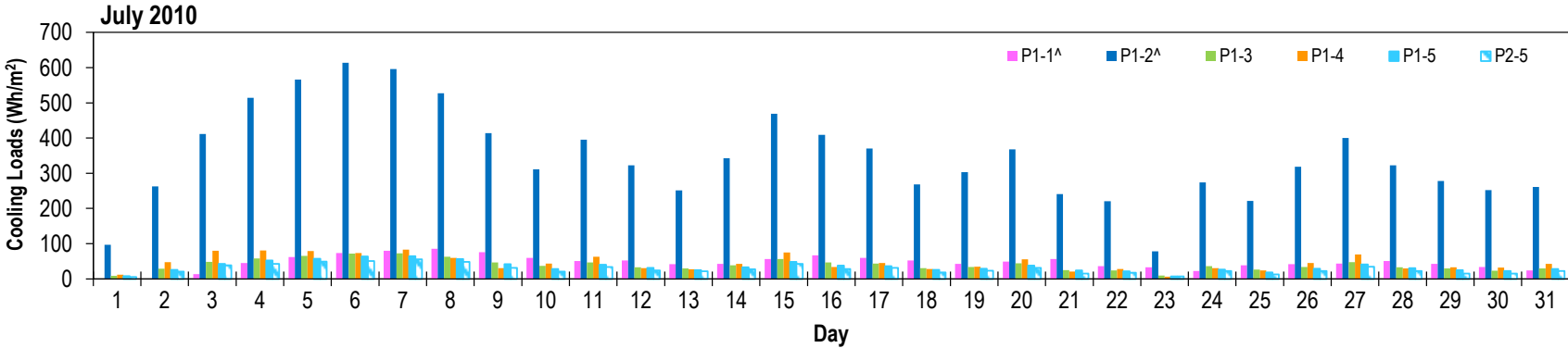
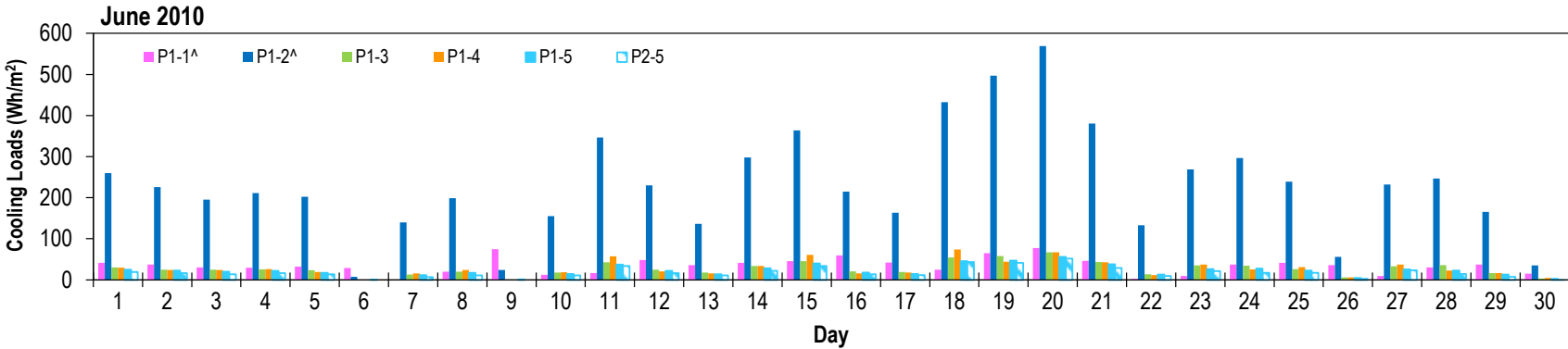

Heating loads (Wh/m²). Refer to Figures 25 thru 28 for sensor location.

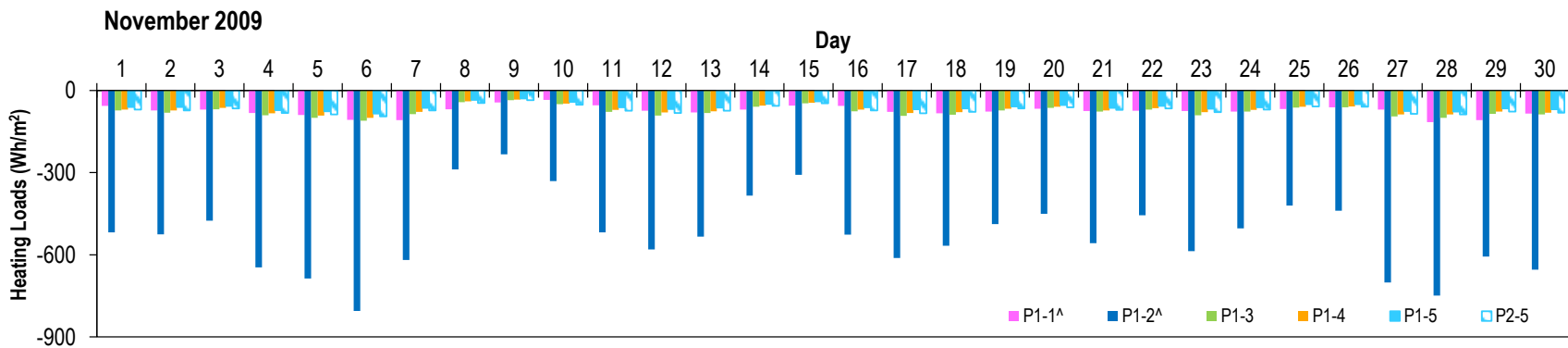
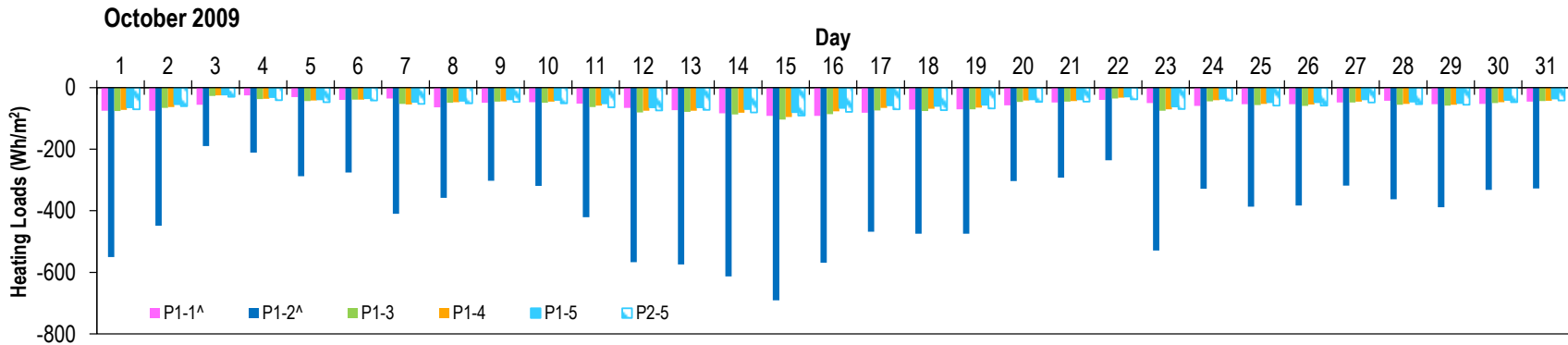
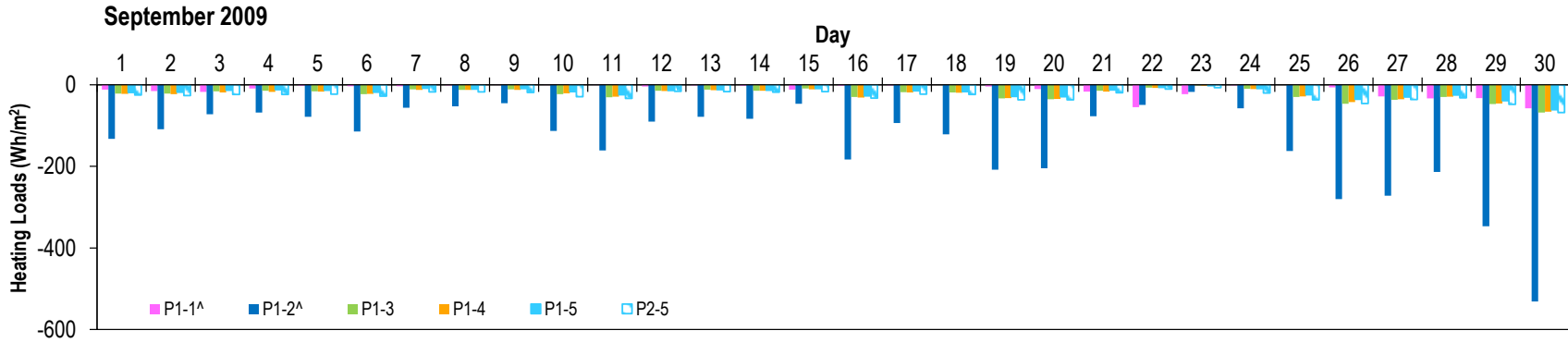

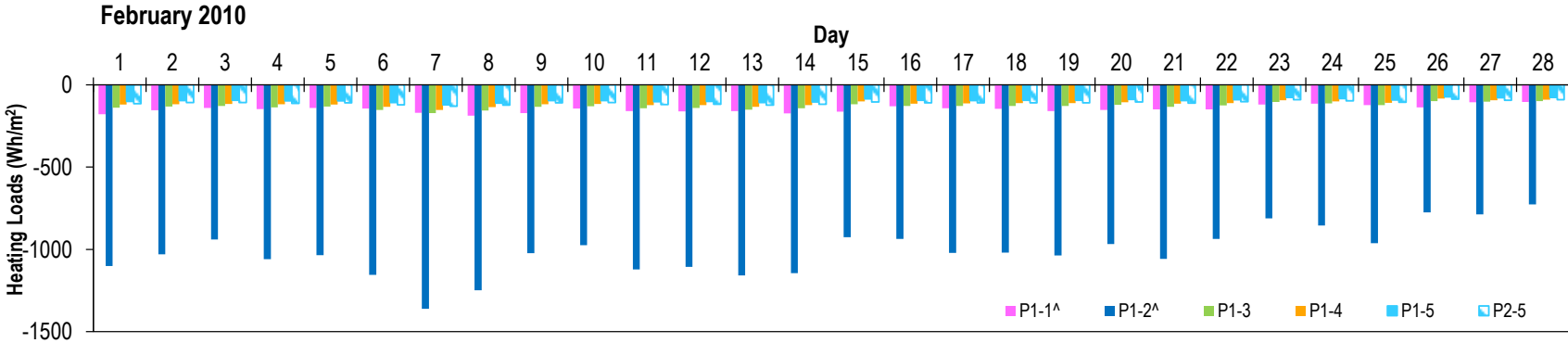
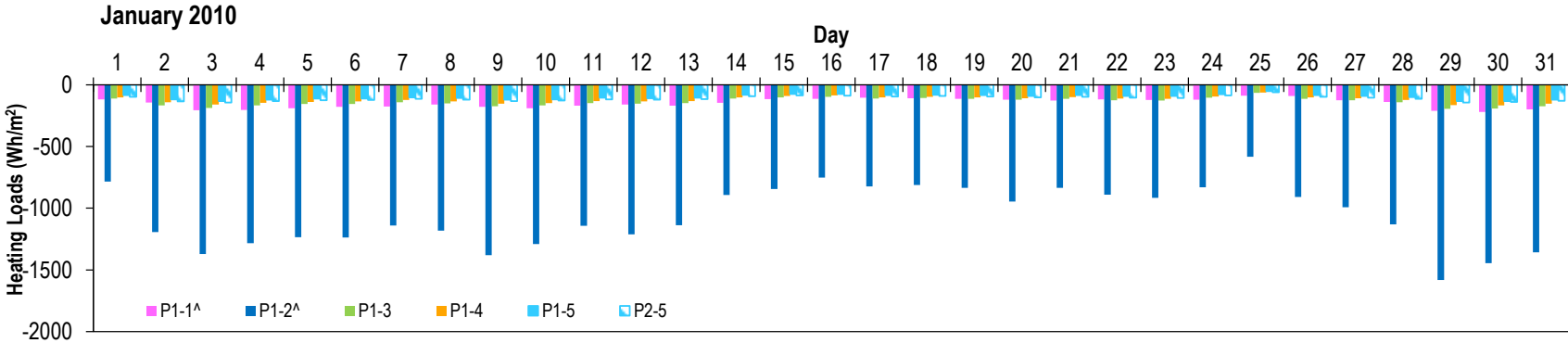
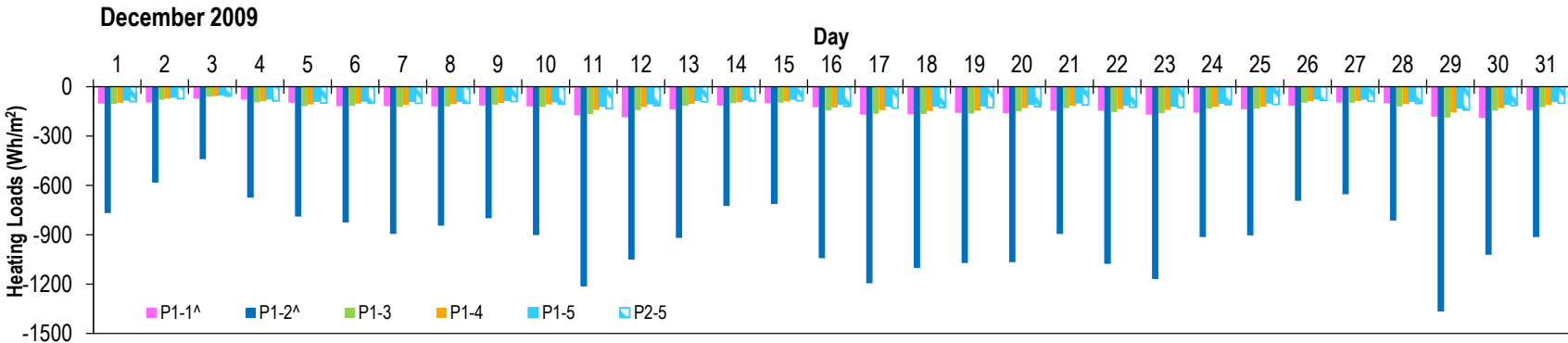

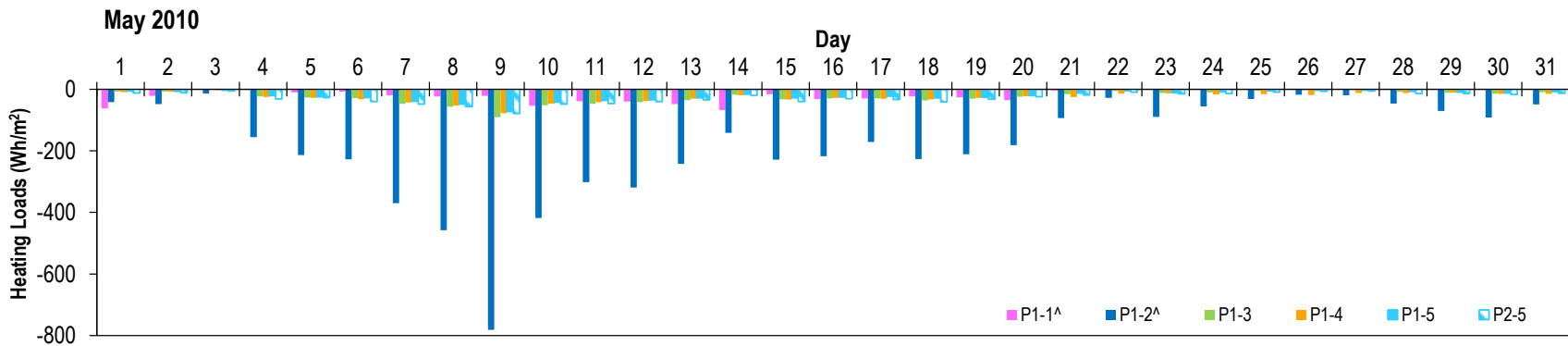
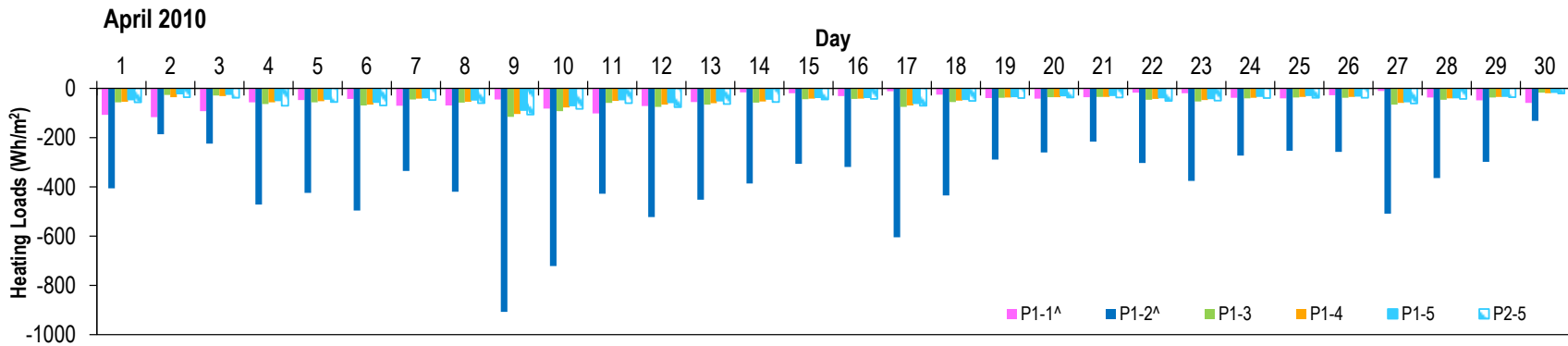
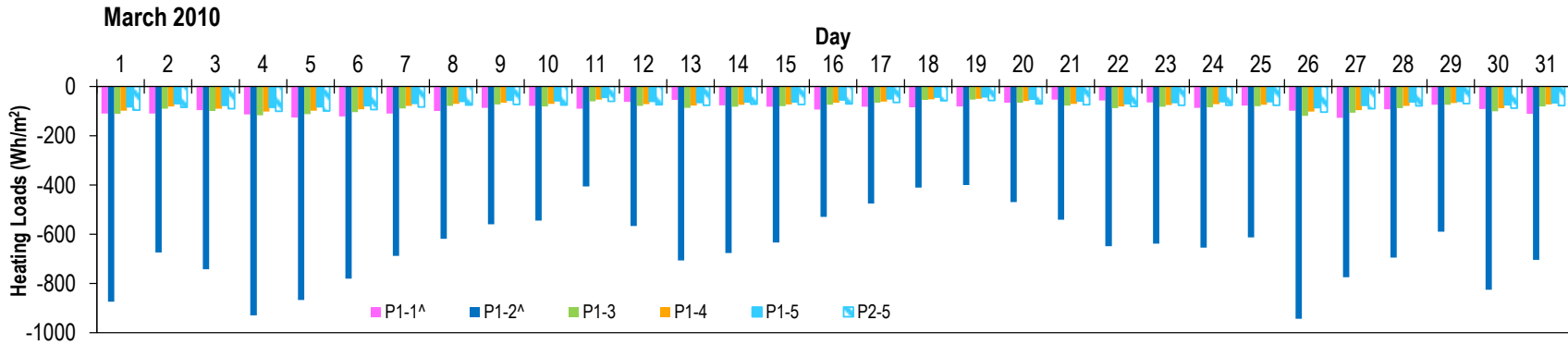

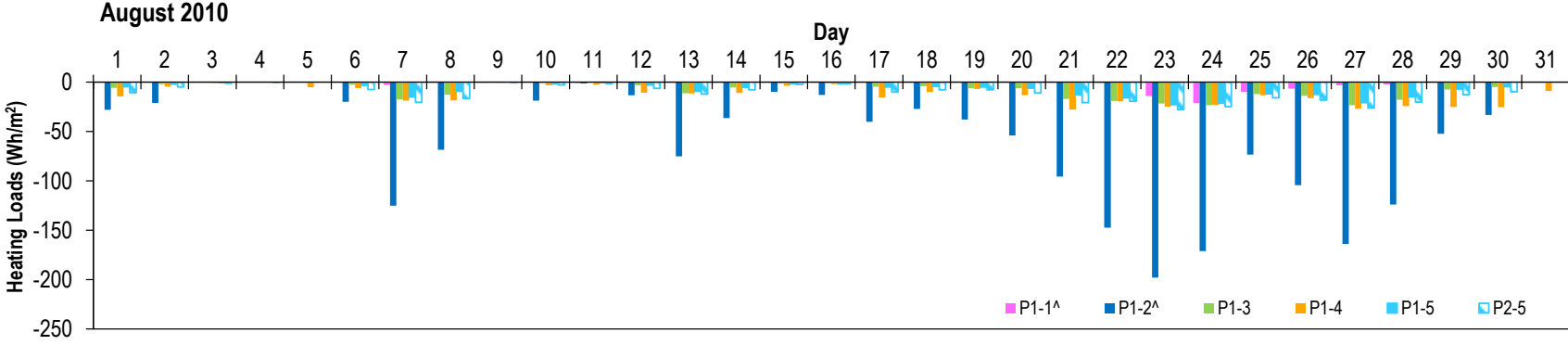
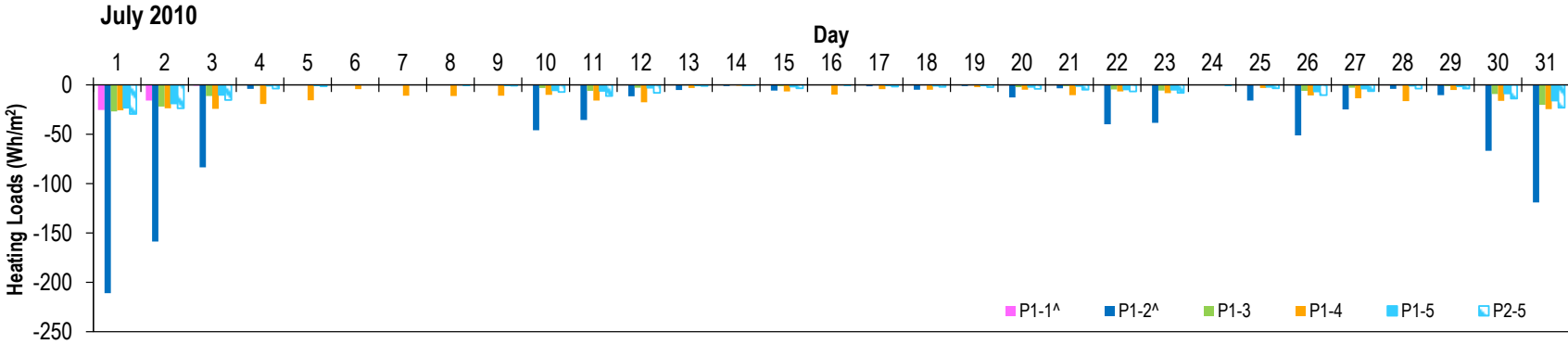
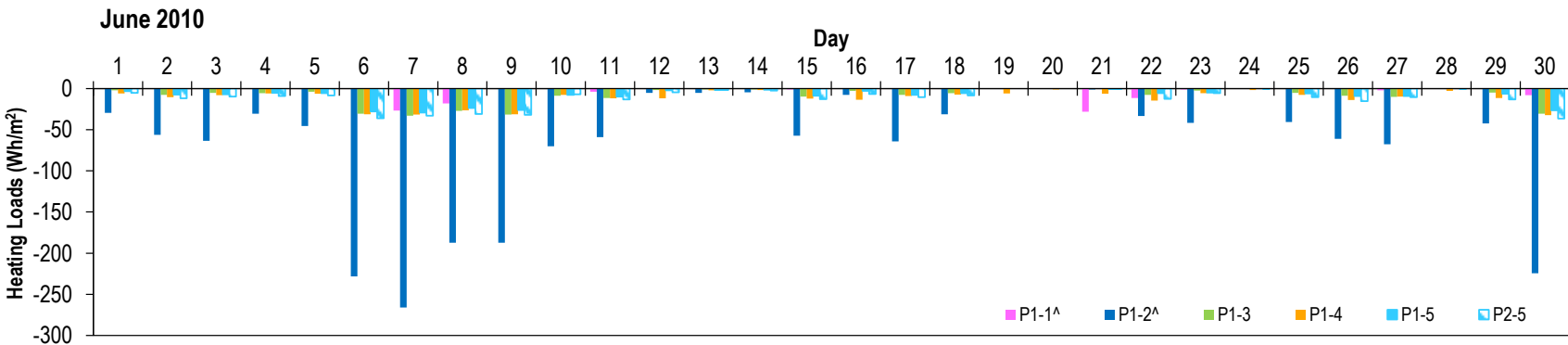

Appendix E: Solar Radiation

North insolation (KW/m²)

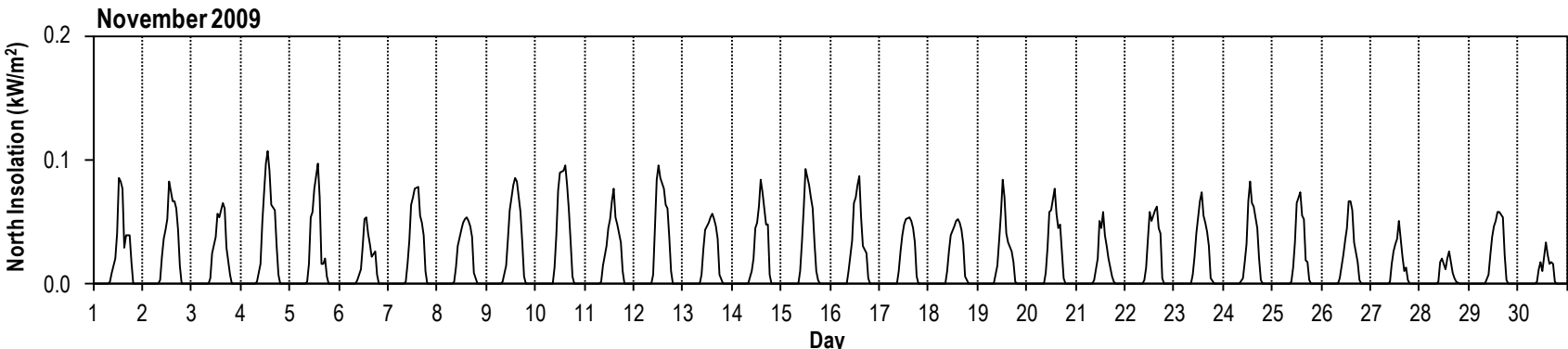
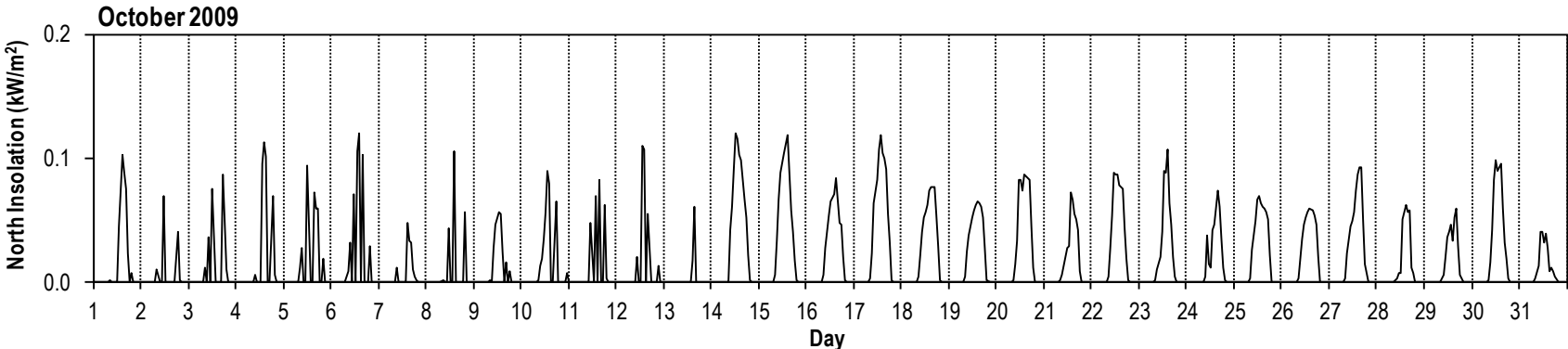
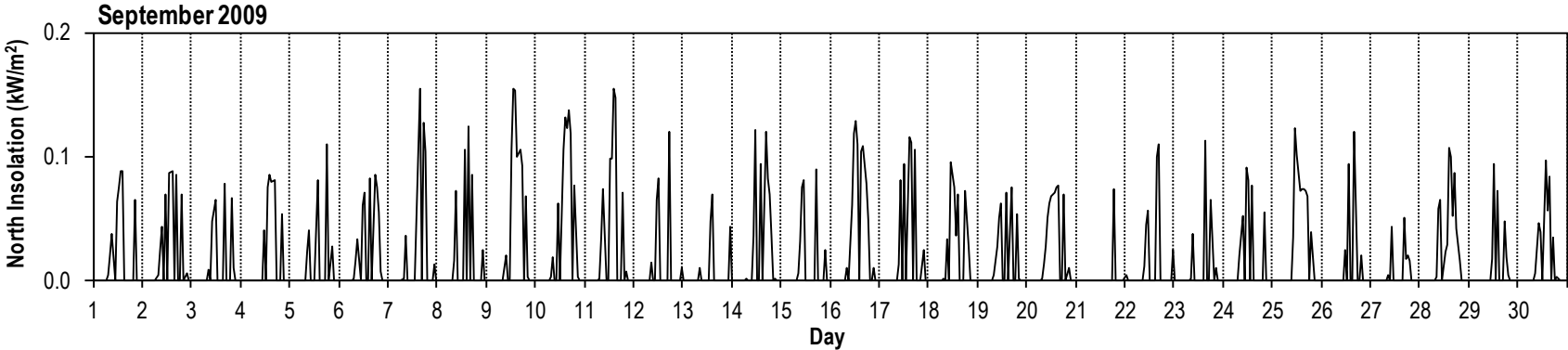

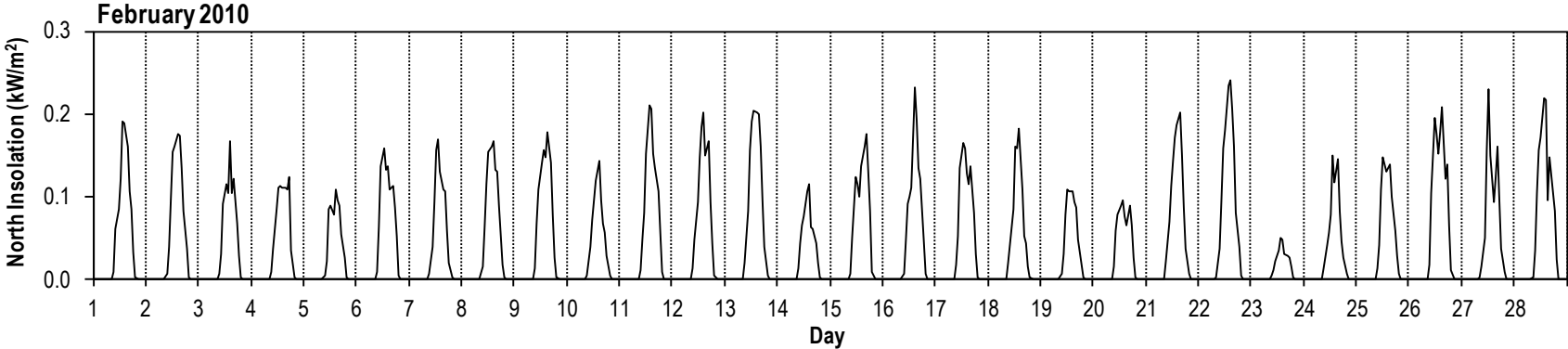
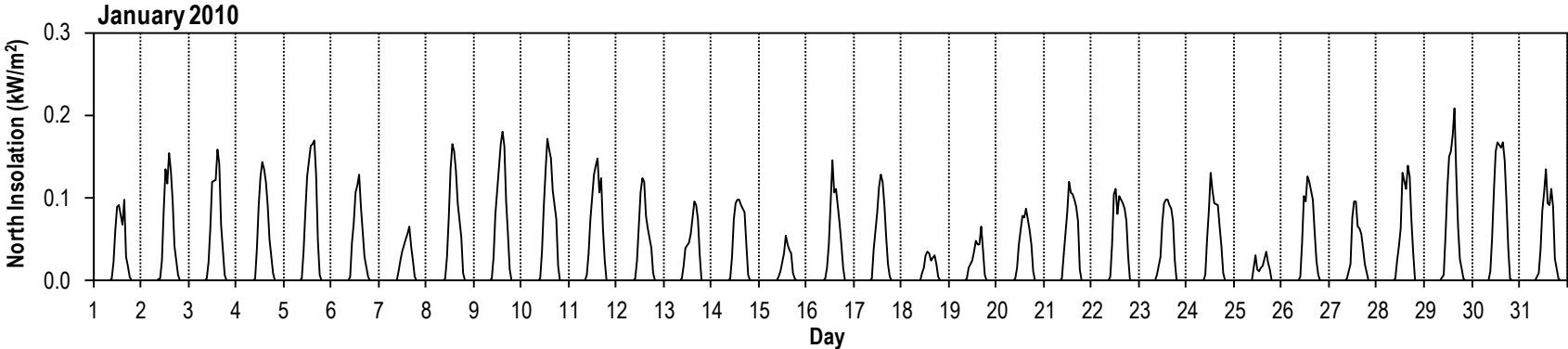
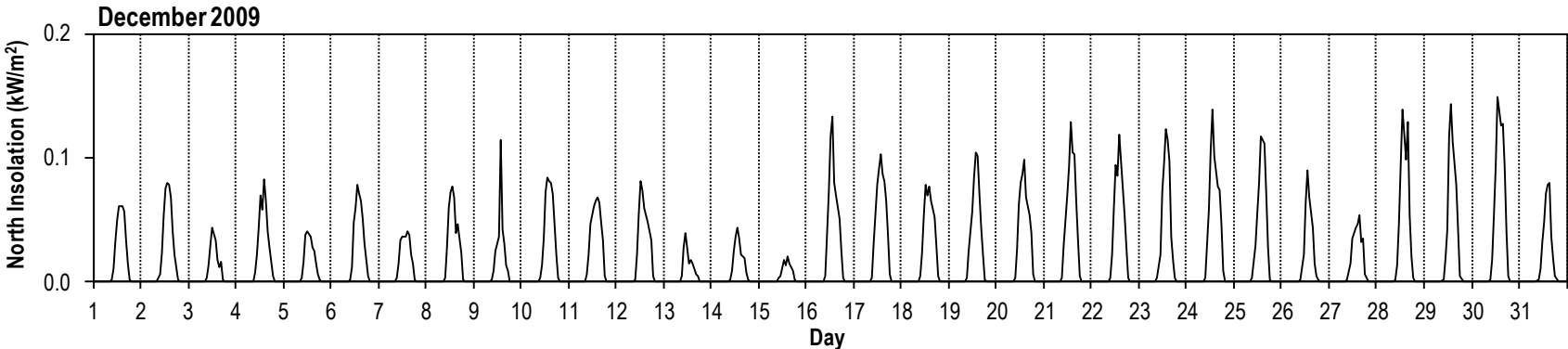

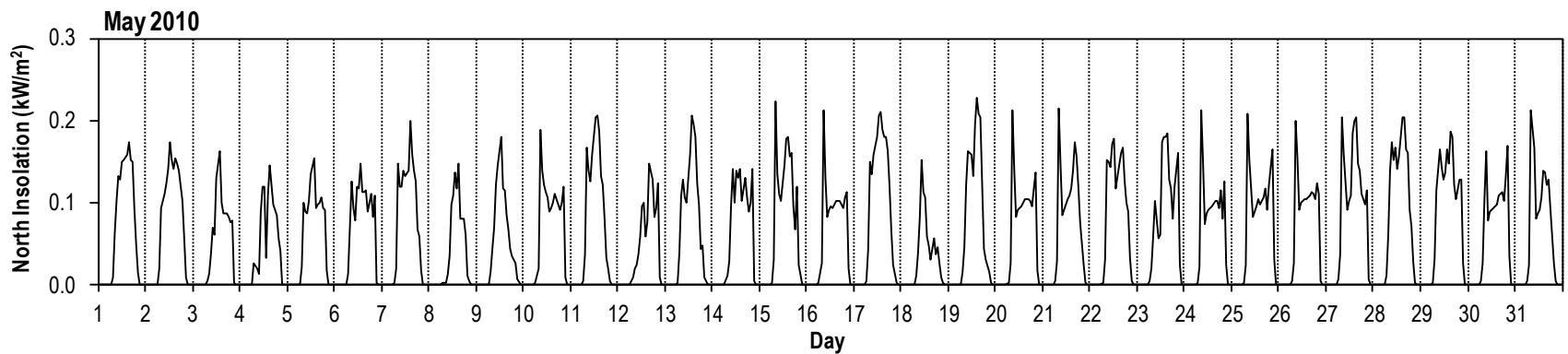
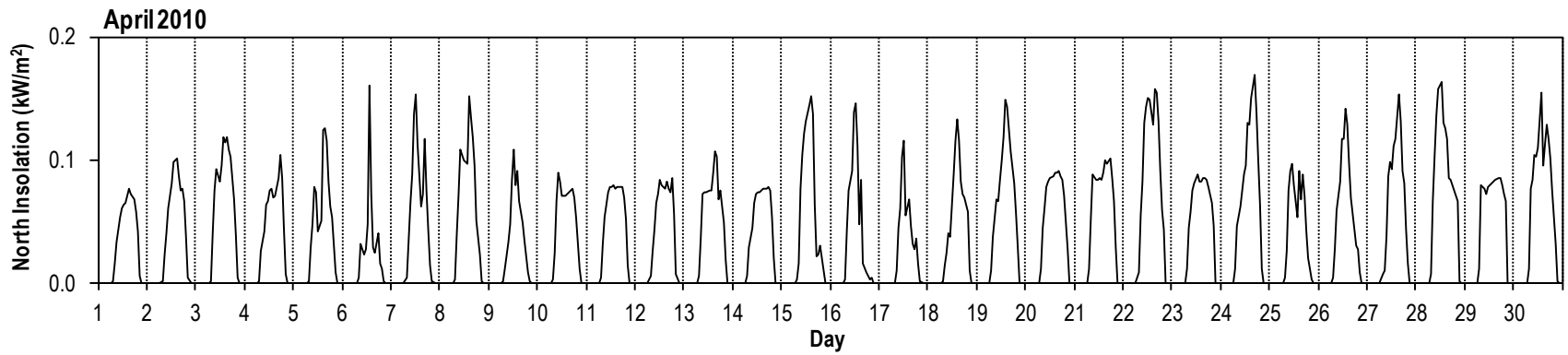
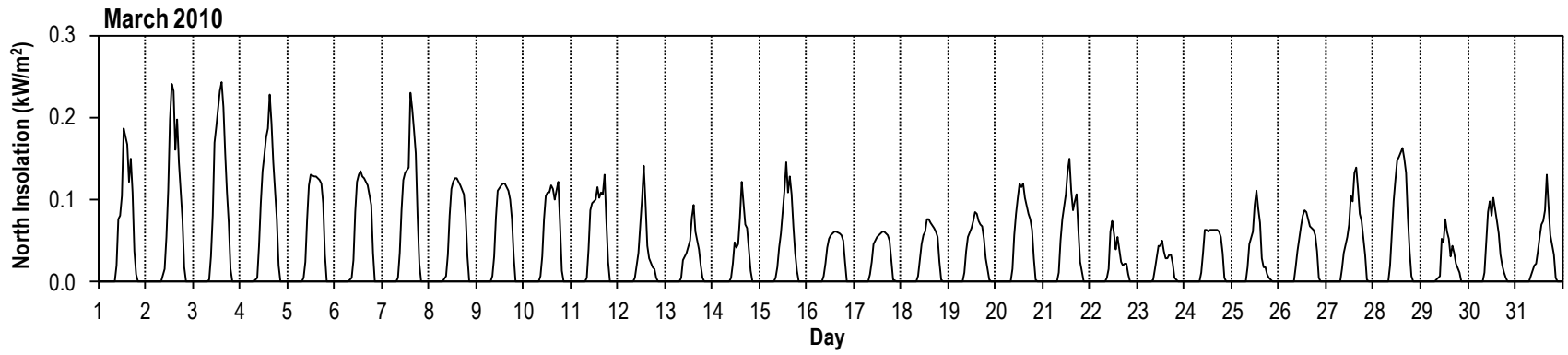

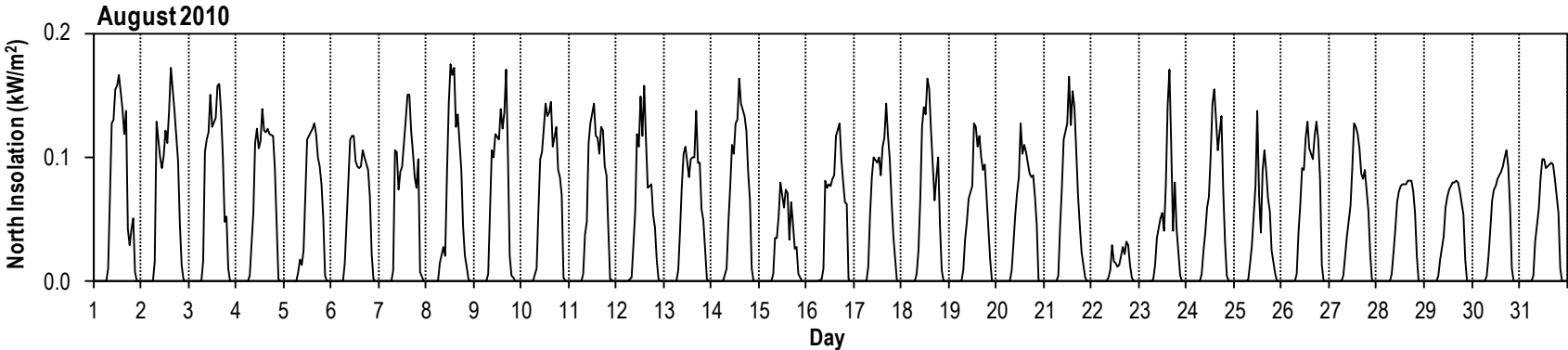
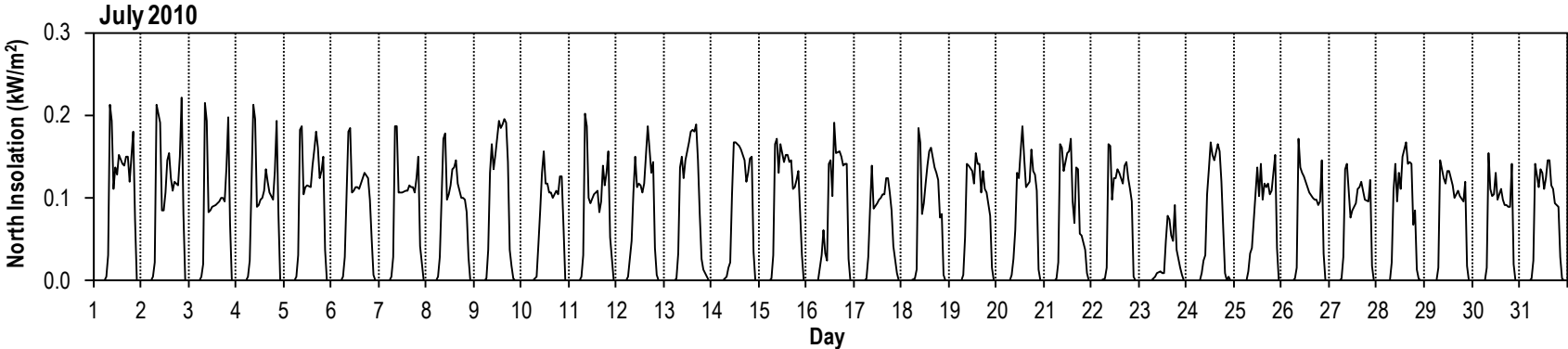
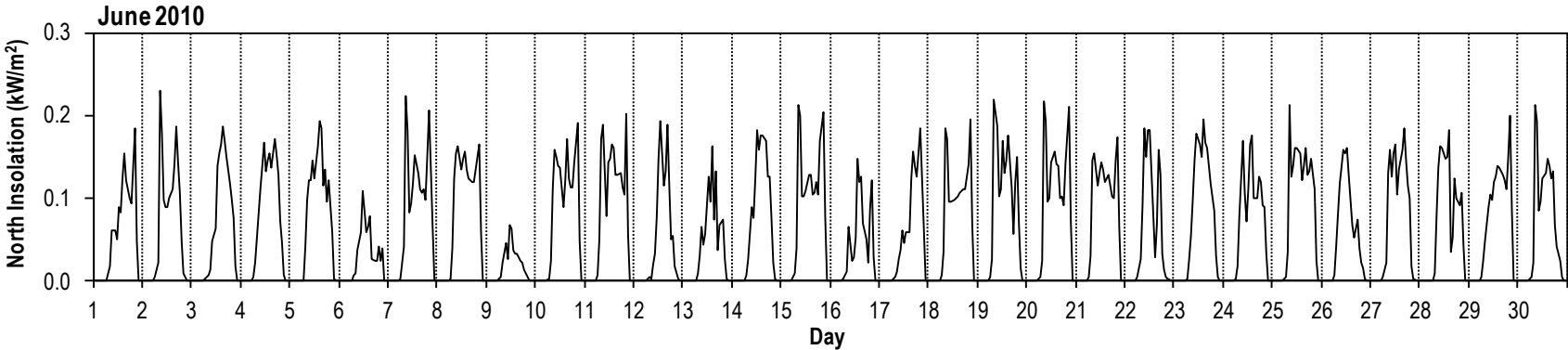

East insolation (KW/m²)

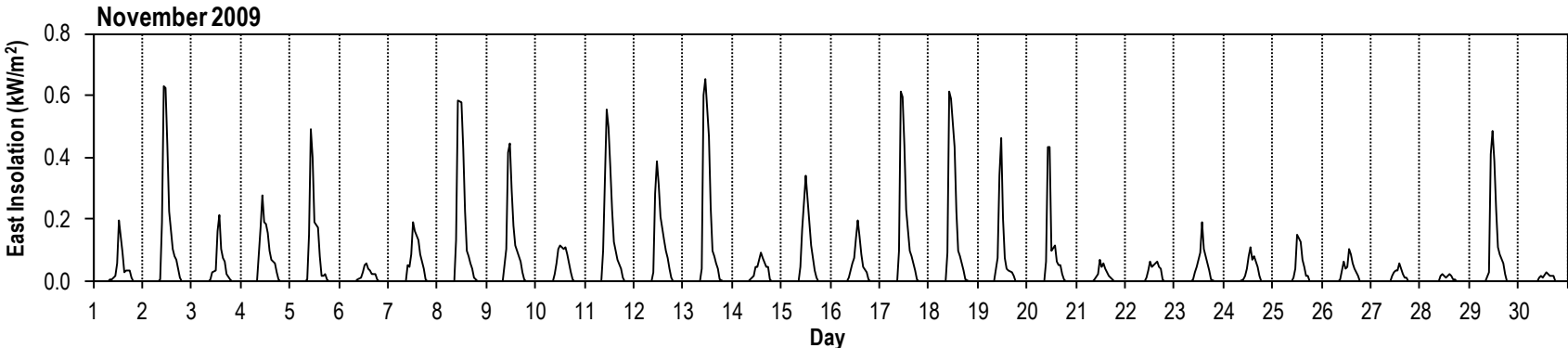
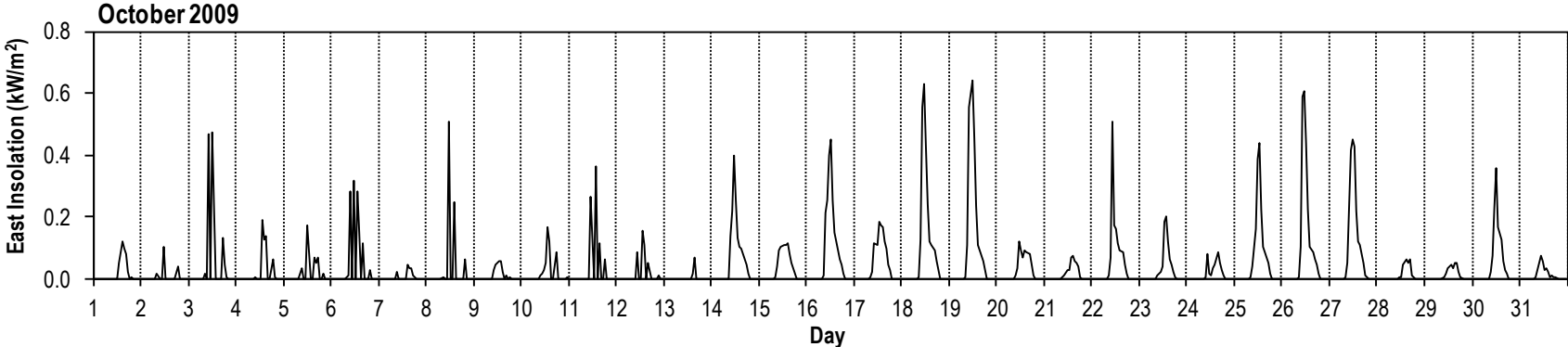
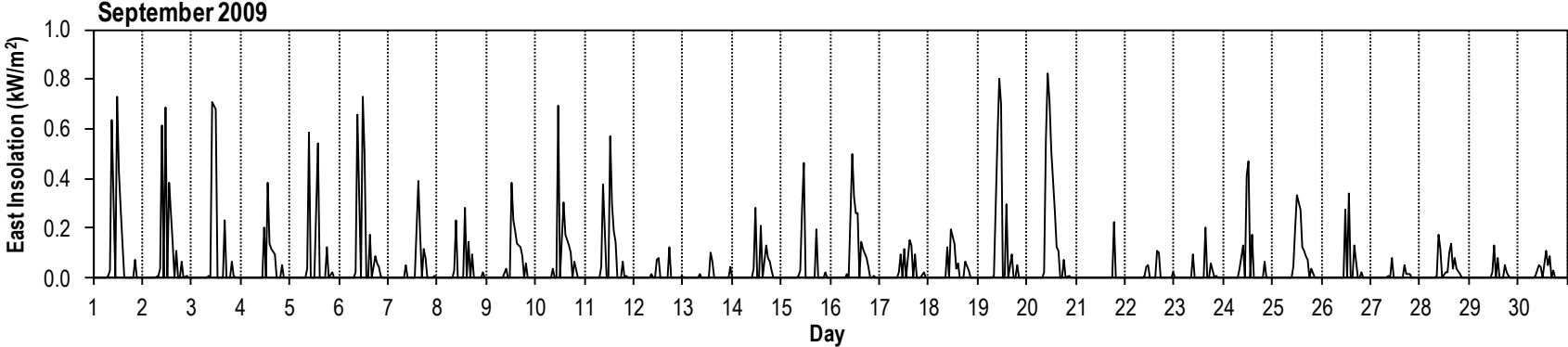

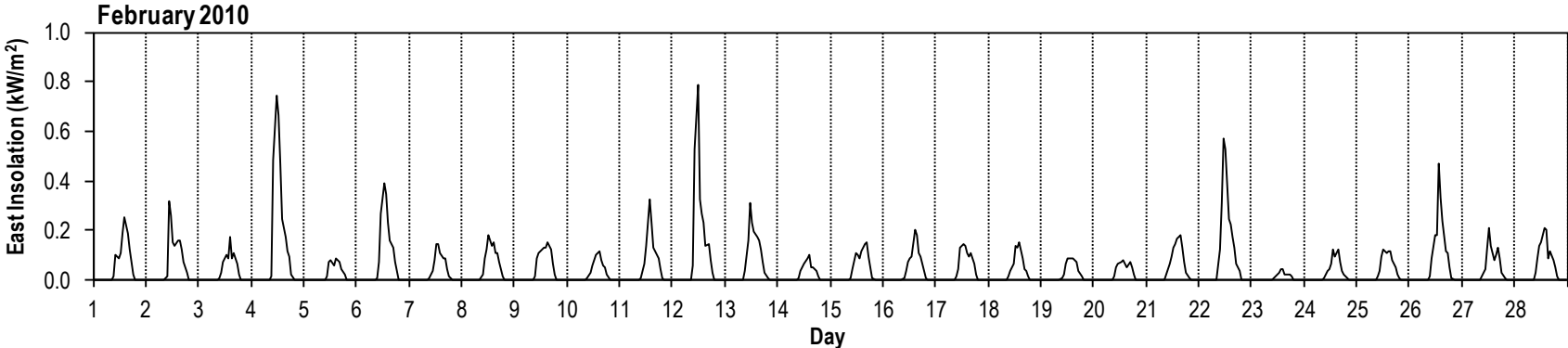
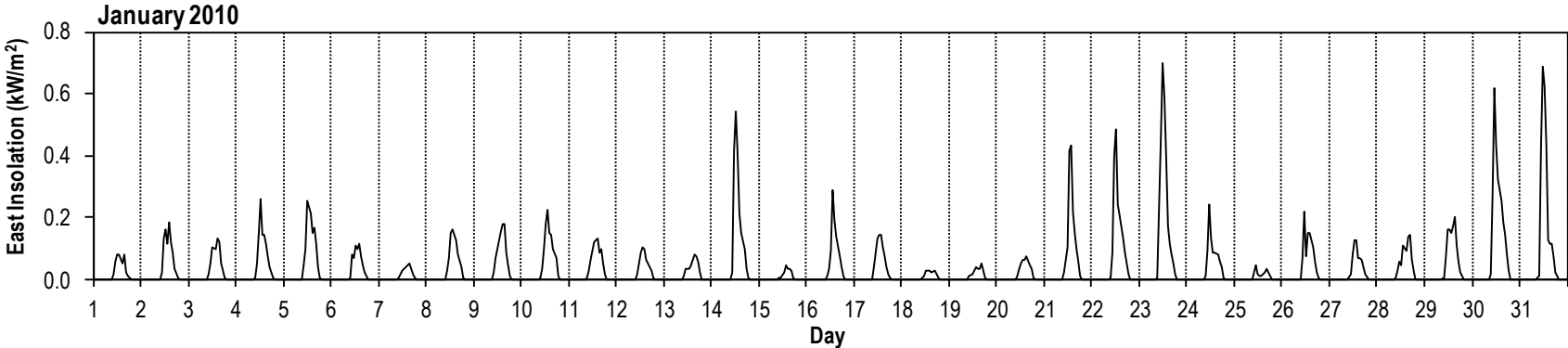
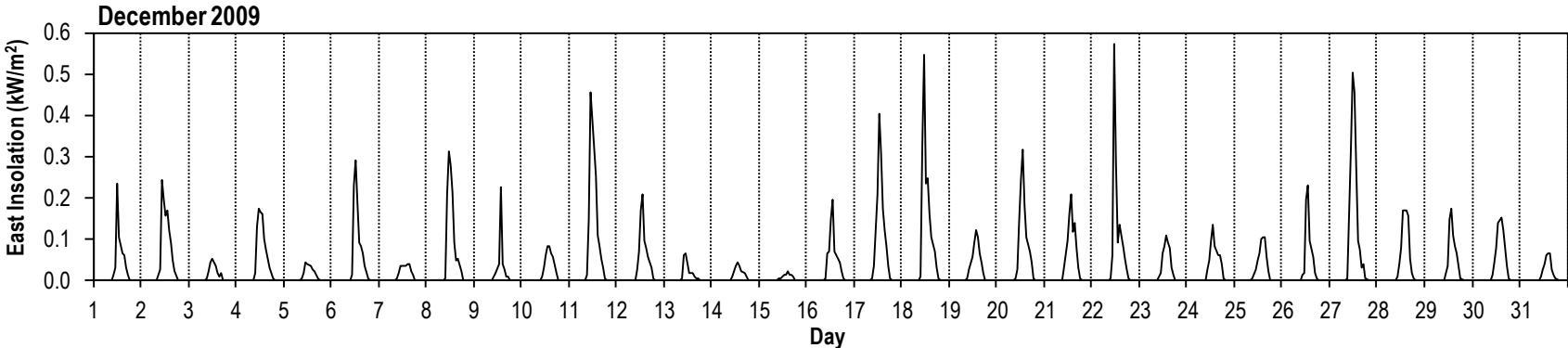

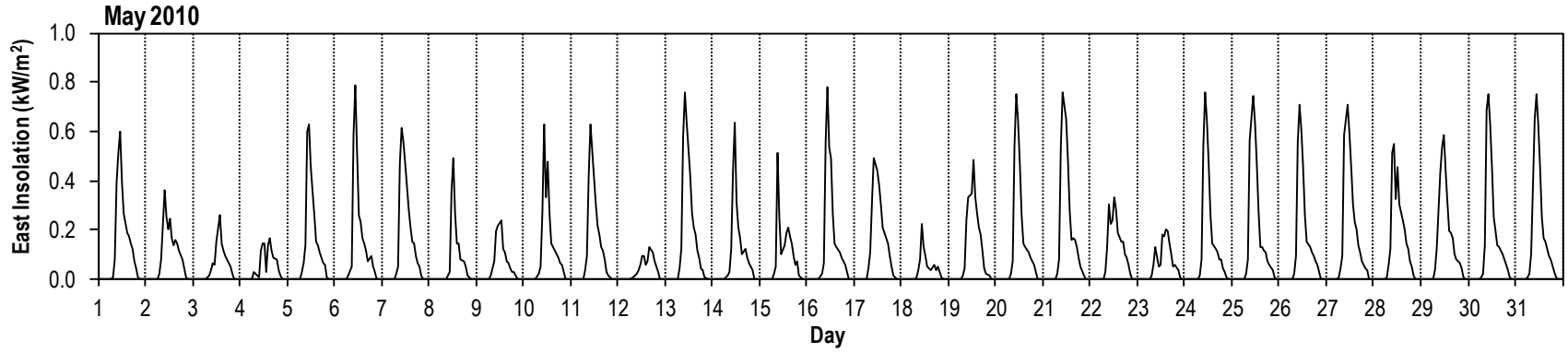
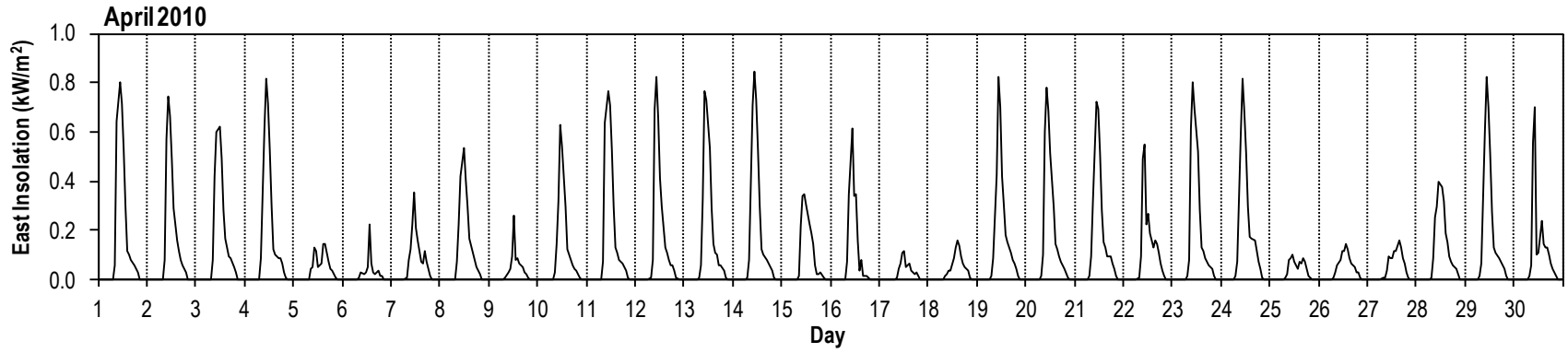
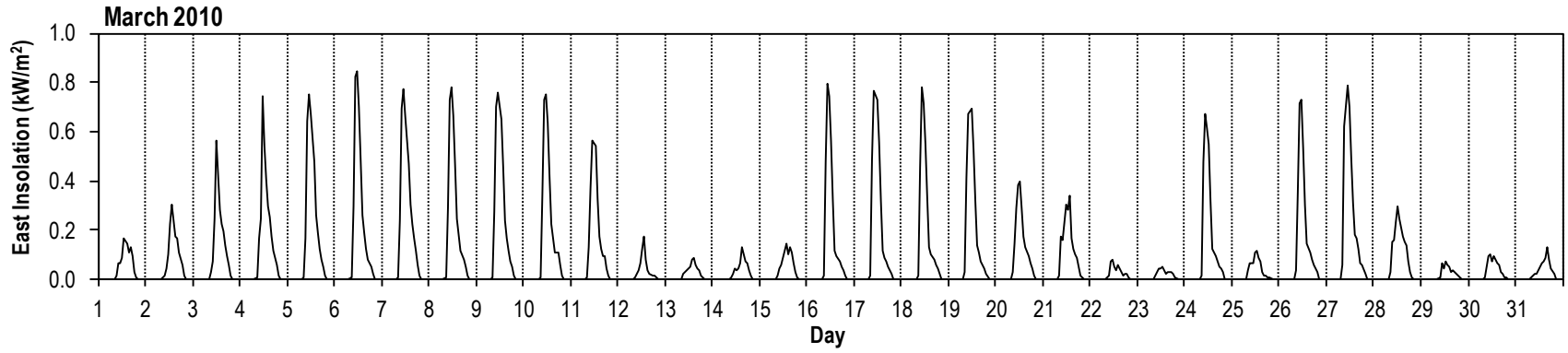

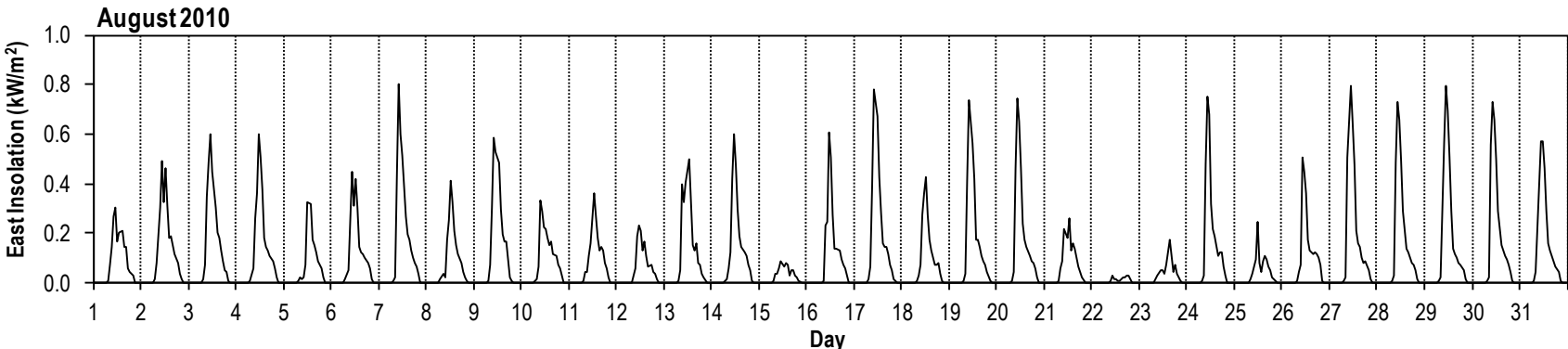
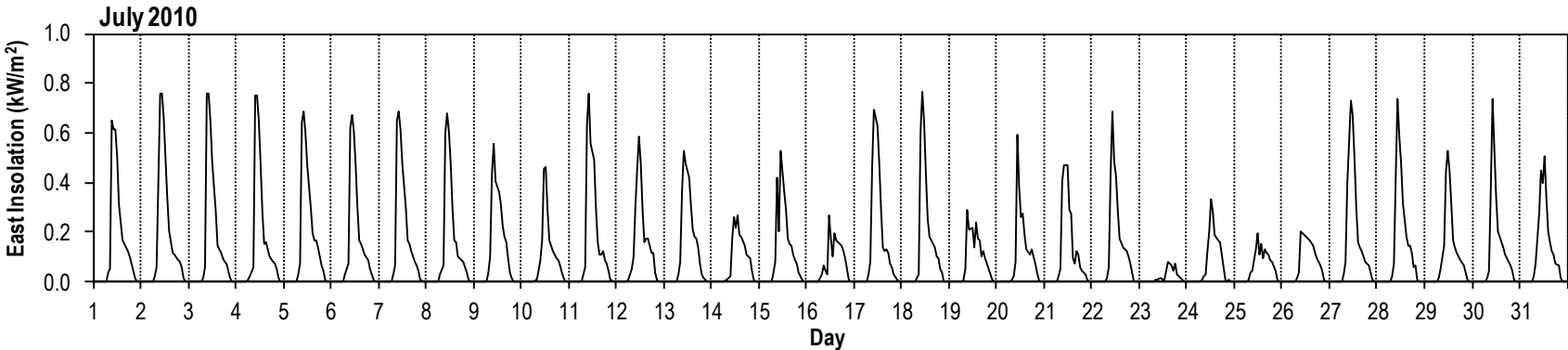
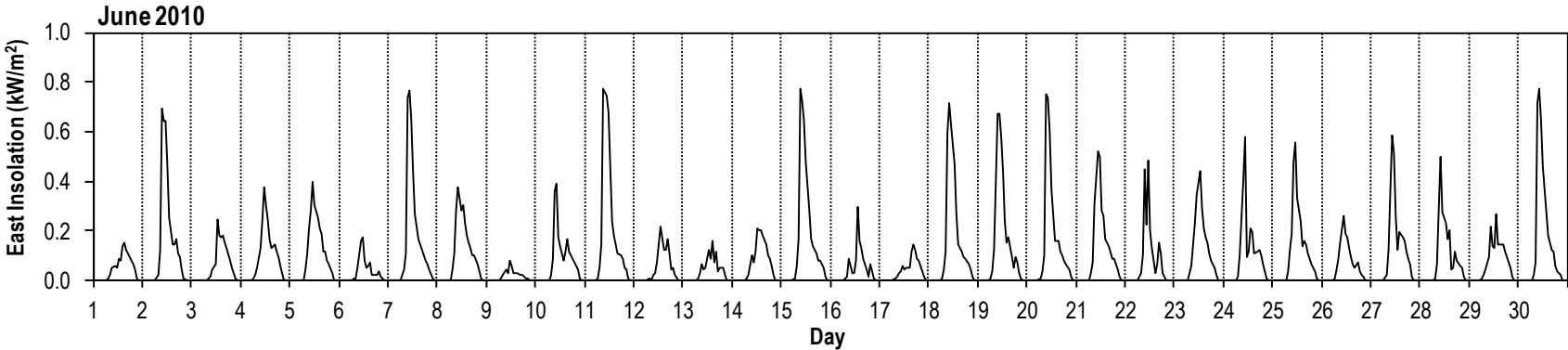

South insolation (KW/m²)

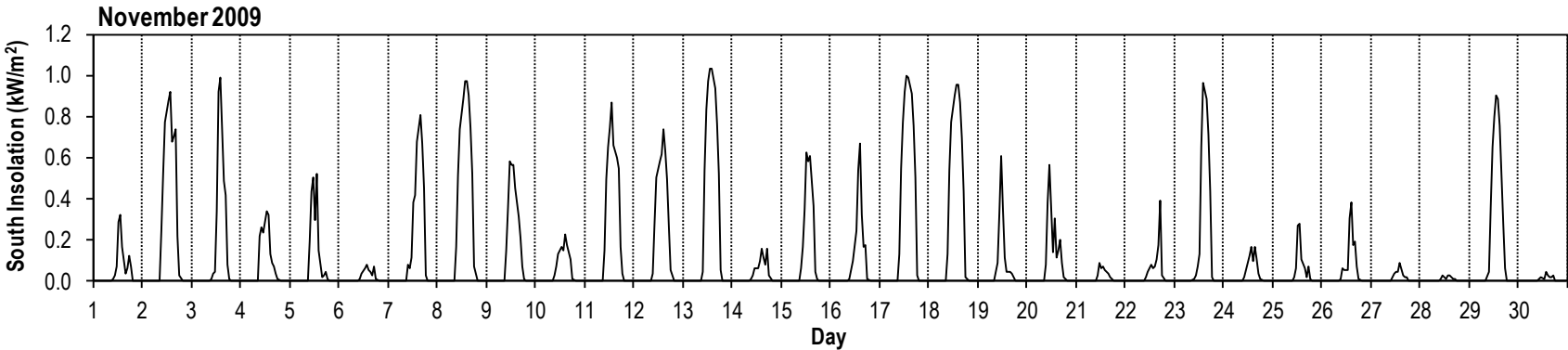
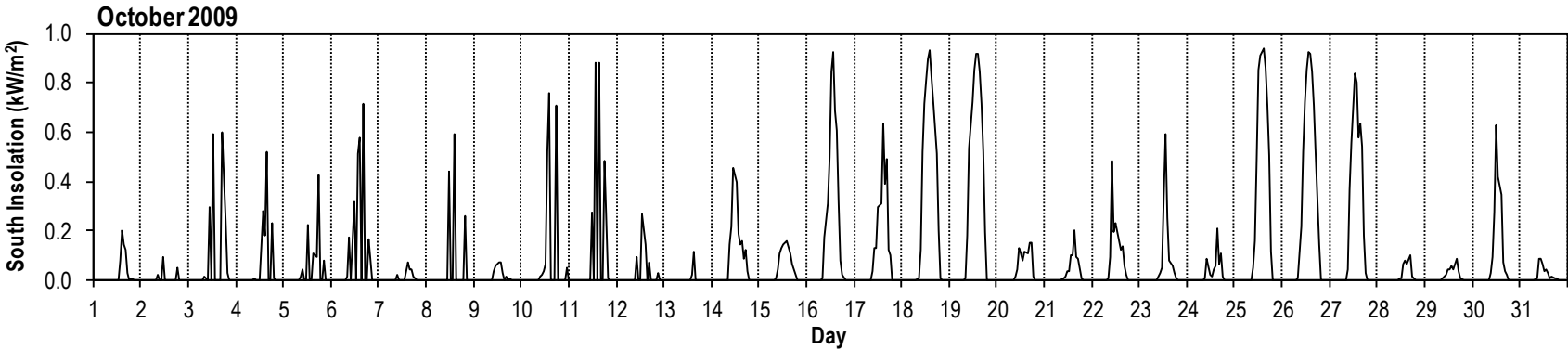
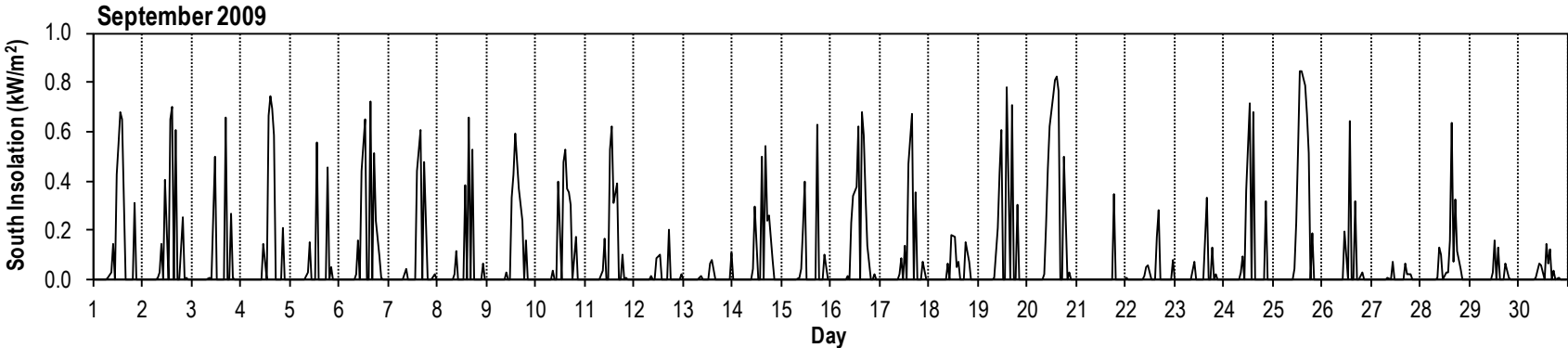

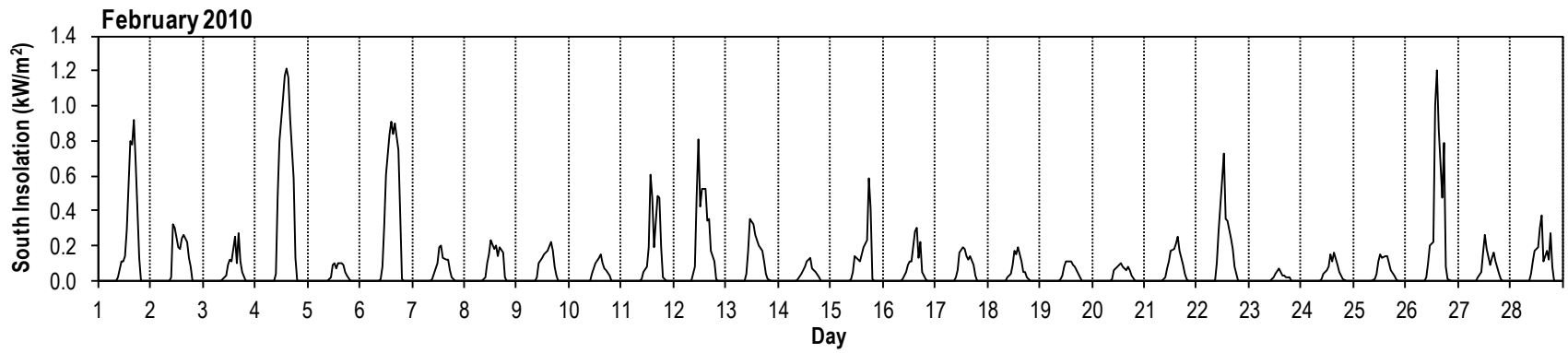
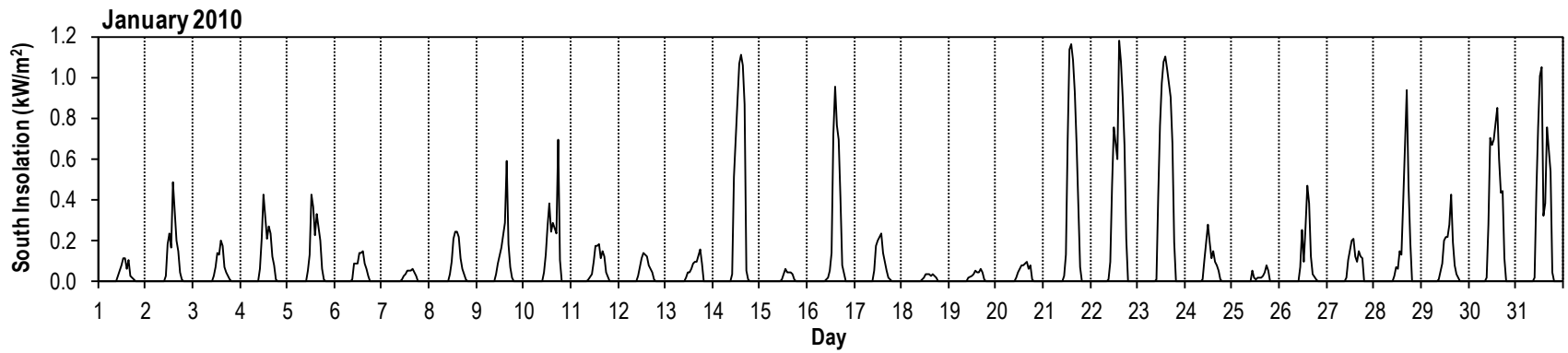
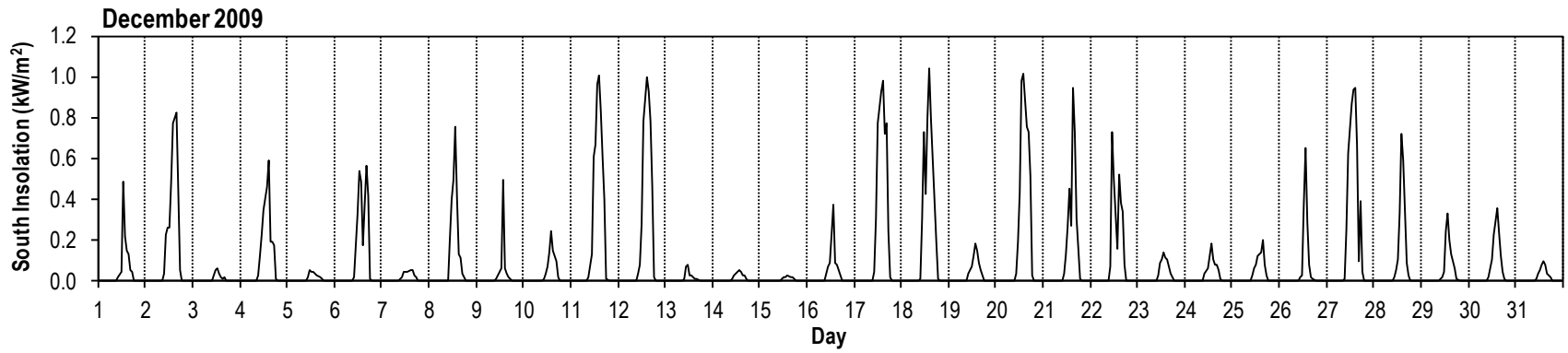

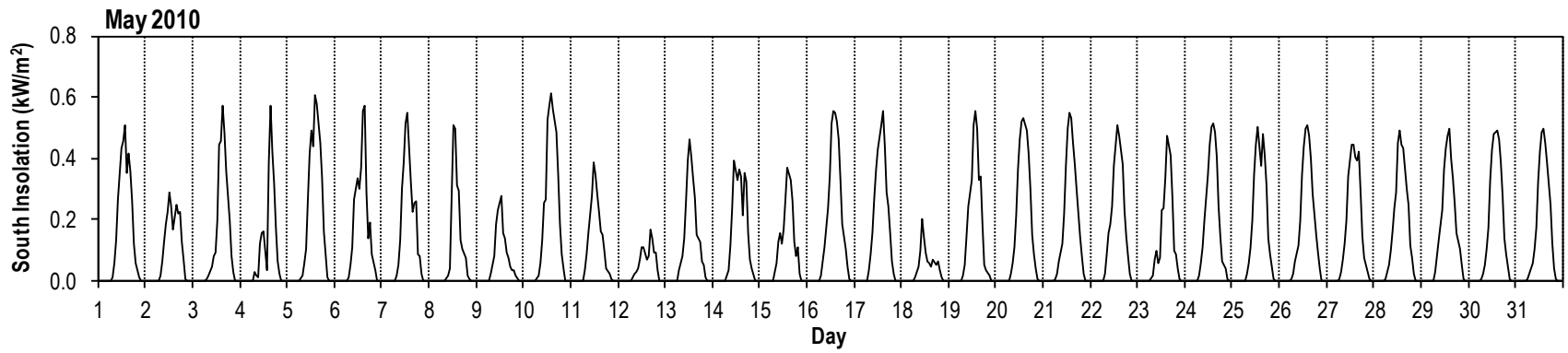
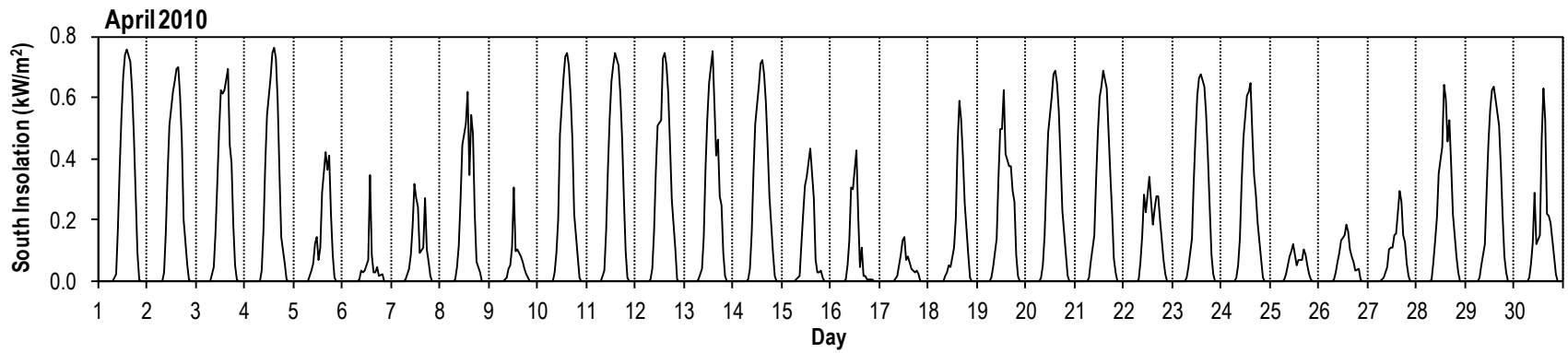
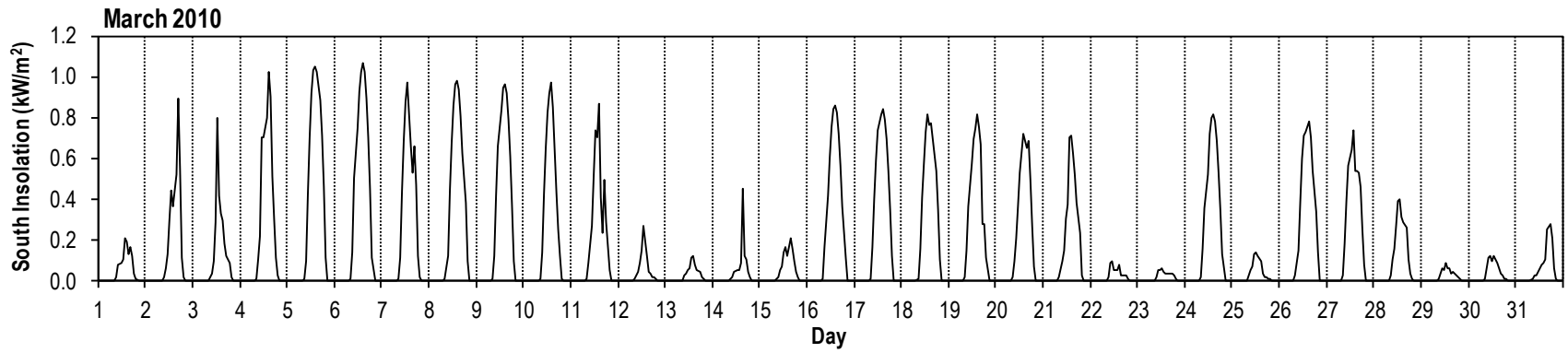

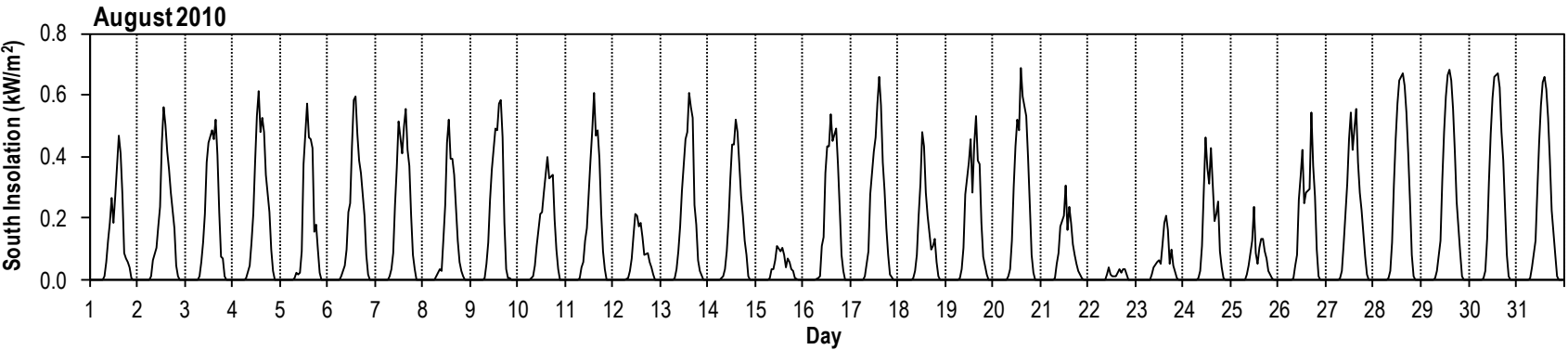
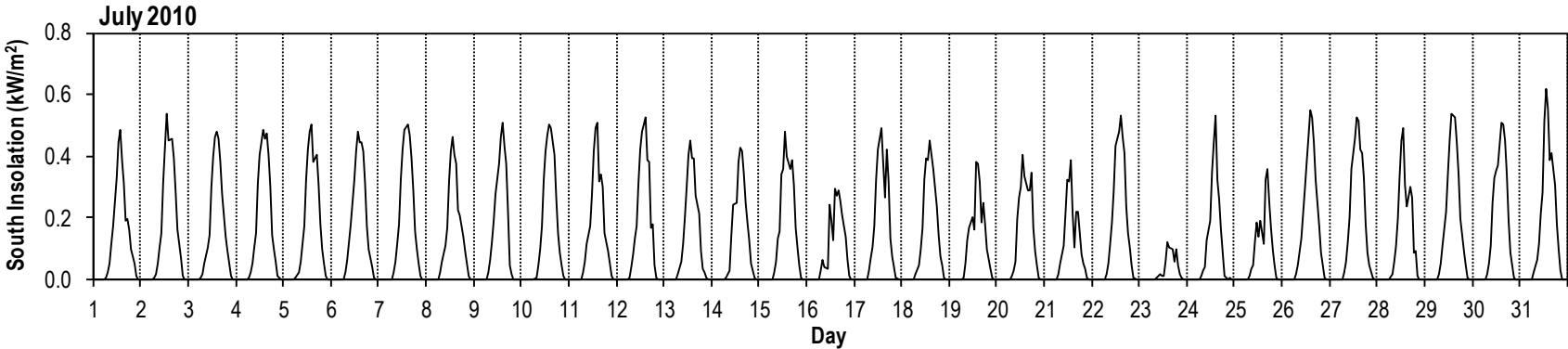
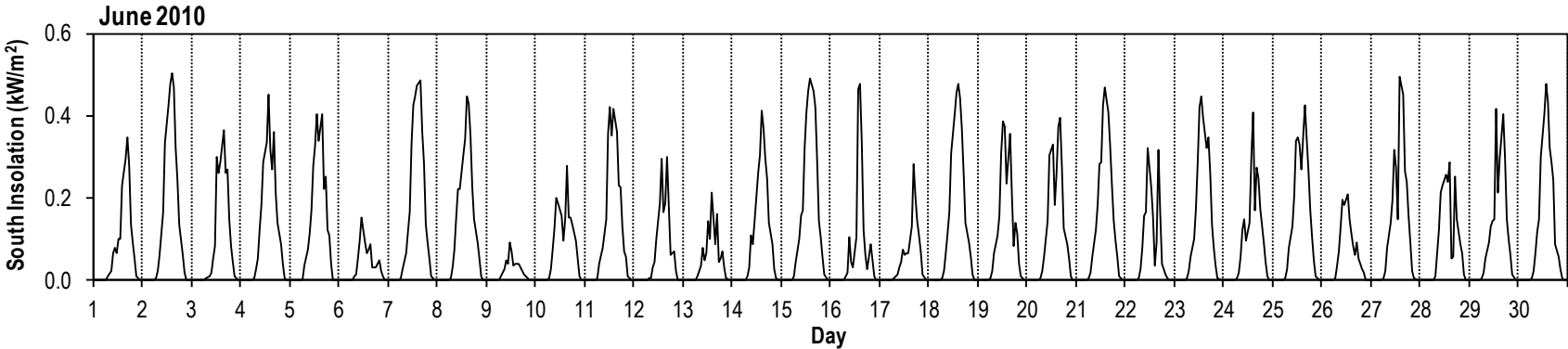

West insolation (KW/m²)

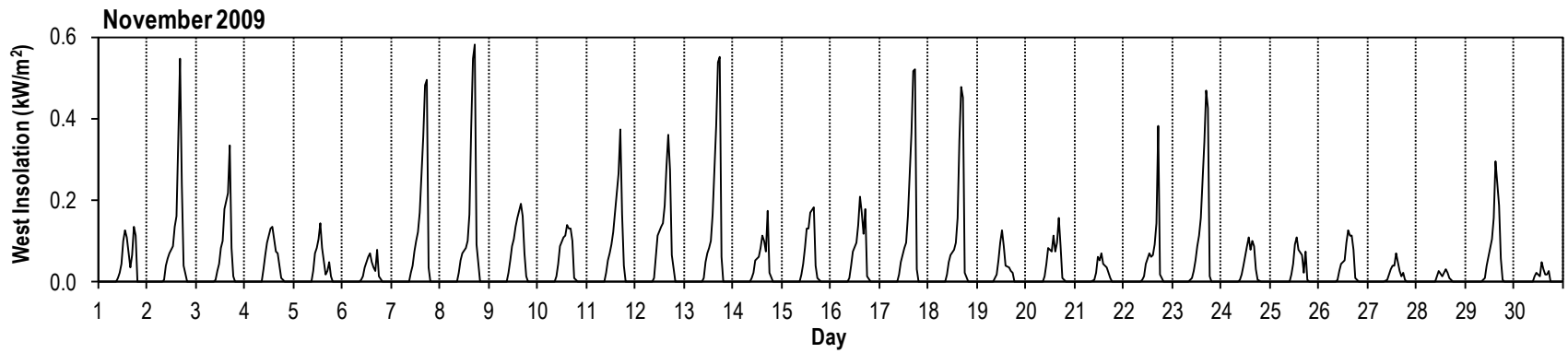
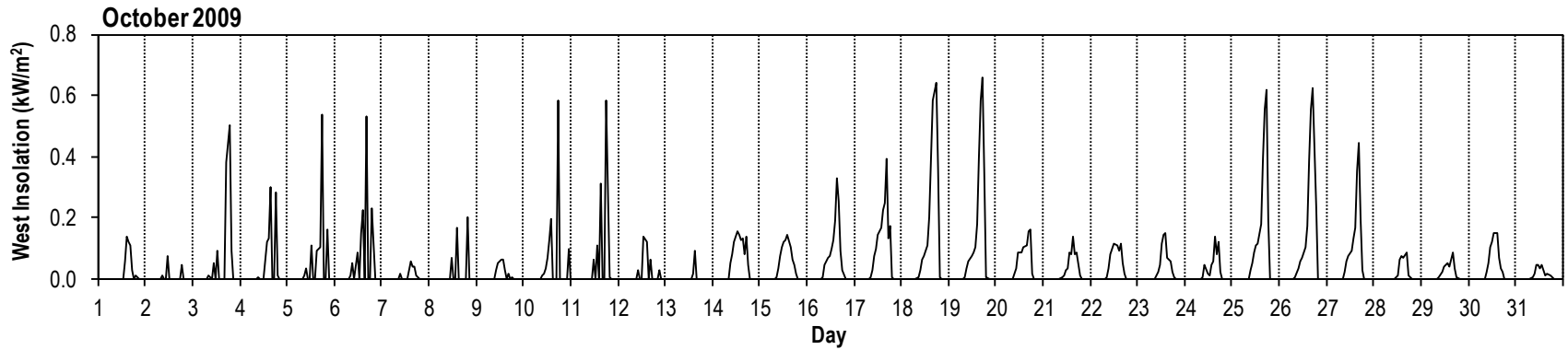
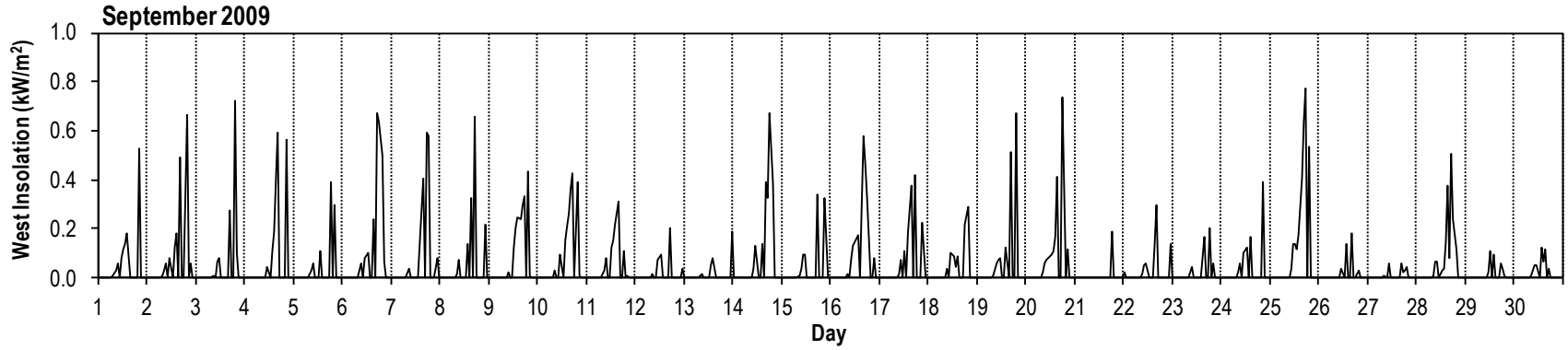

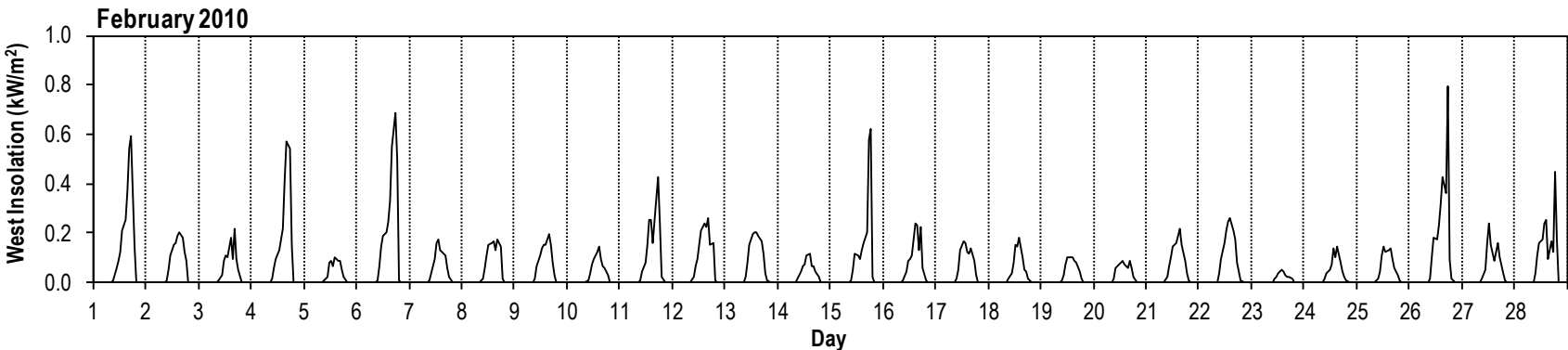
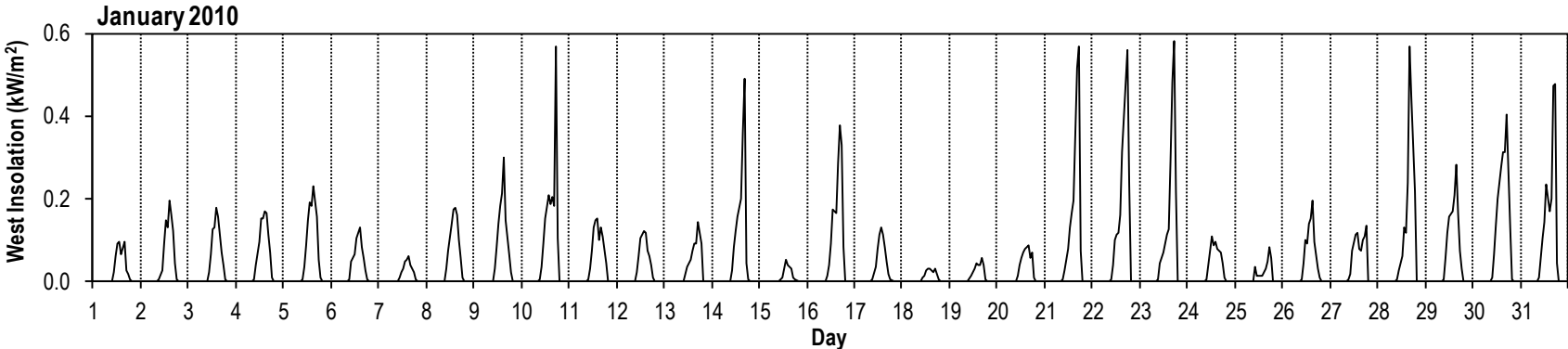
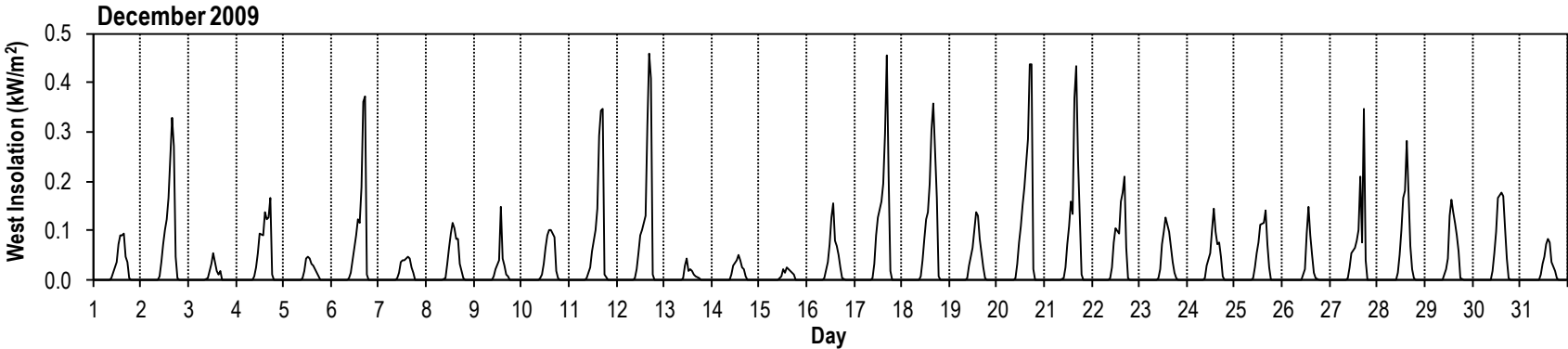

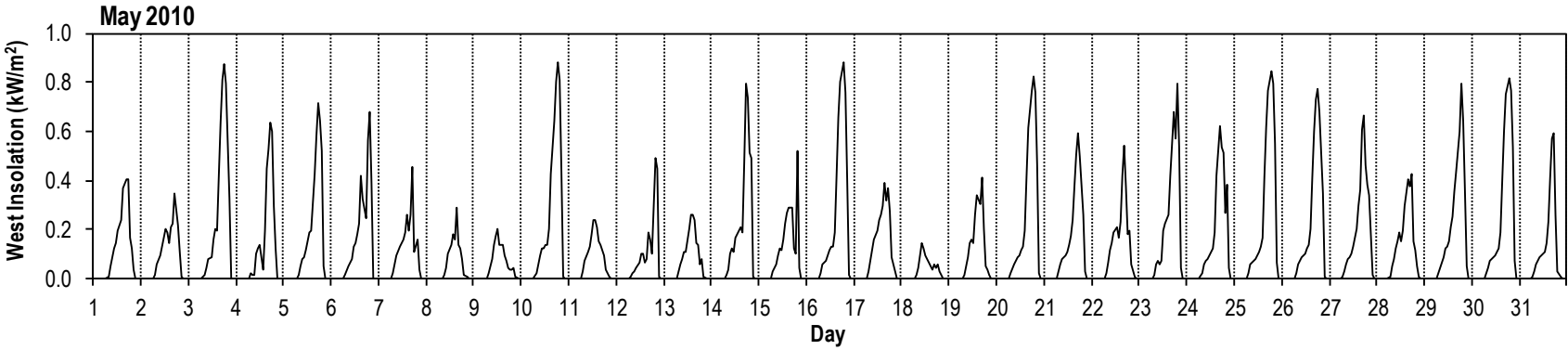
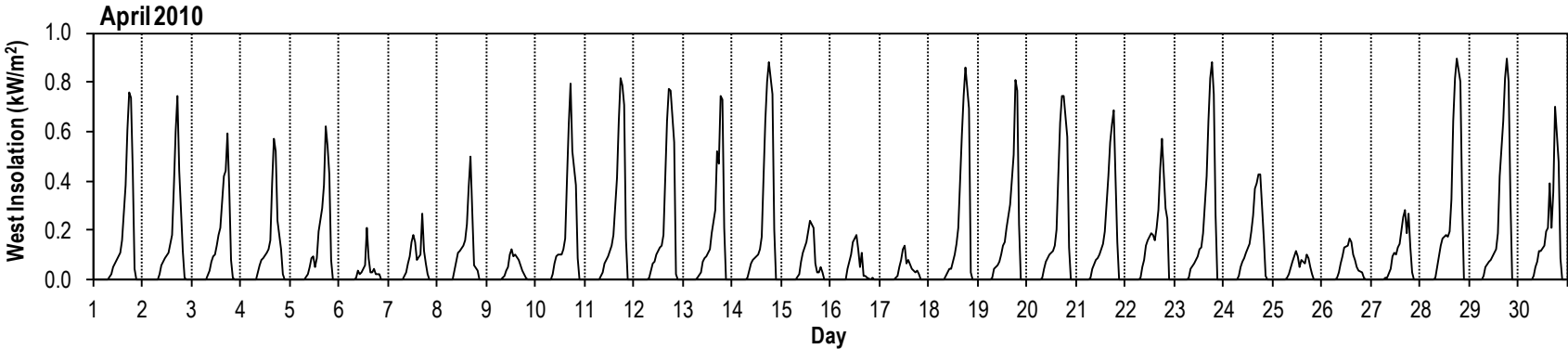
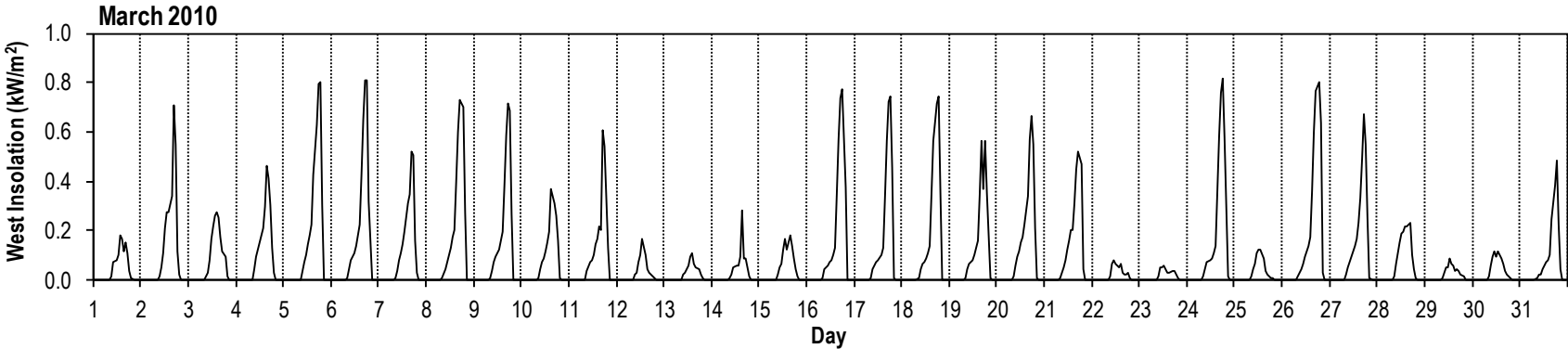

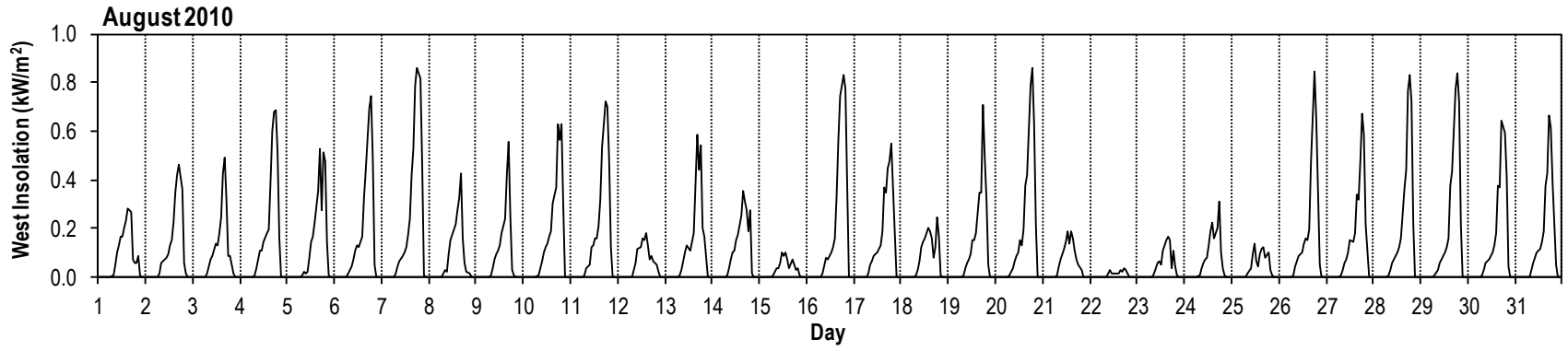
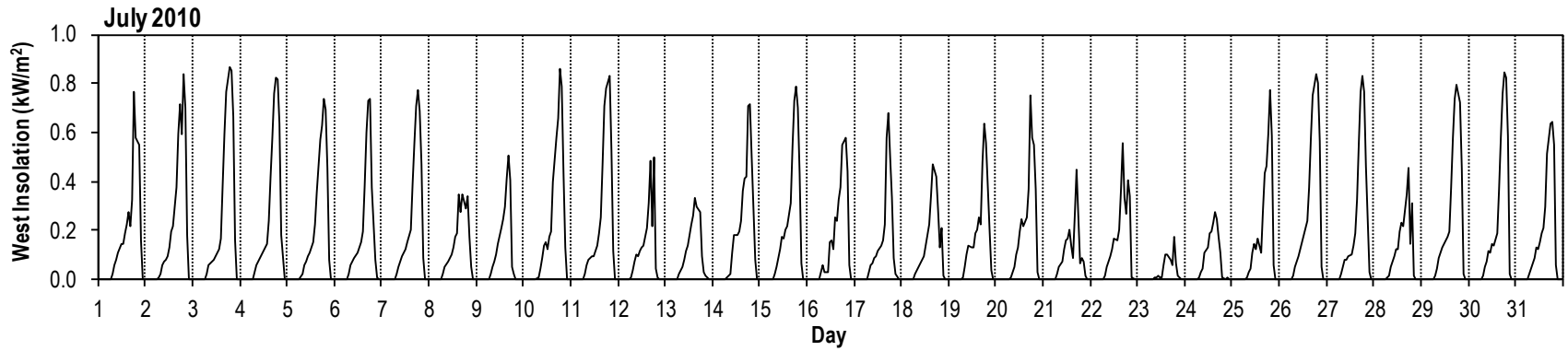
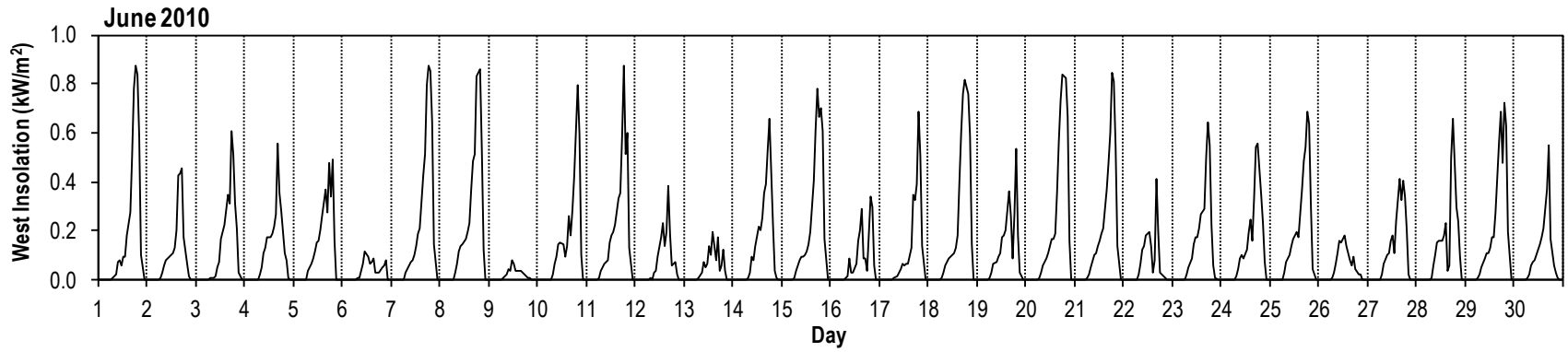

Appendix F: Wind Speed

North wind (m/s)

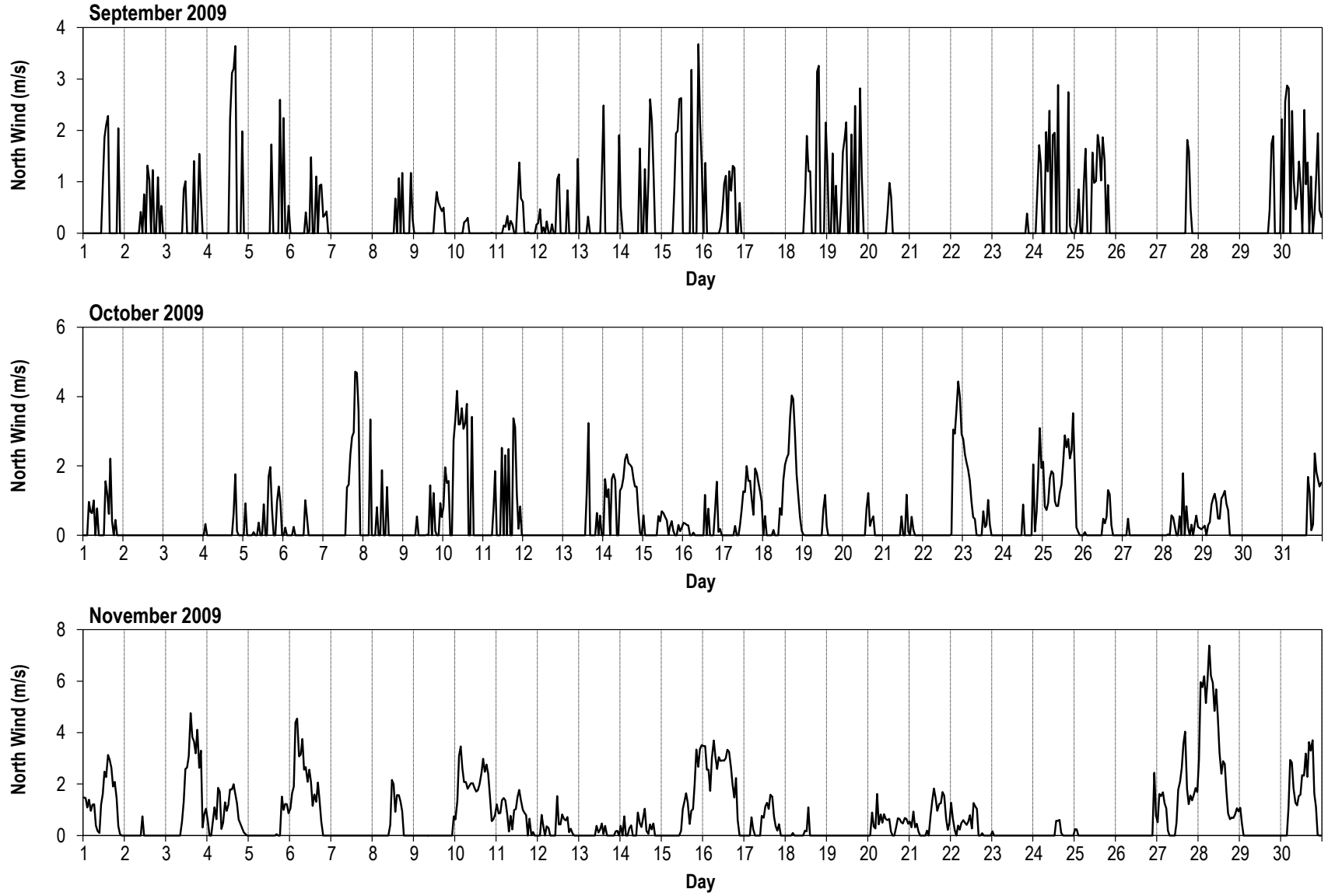

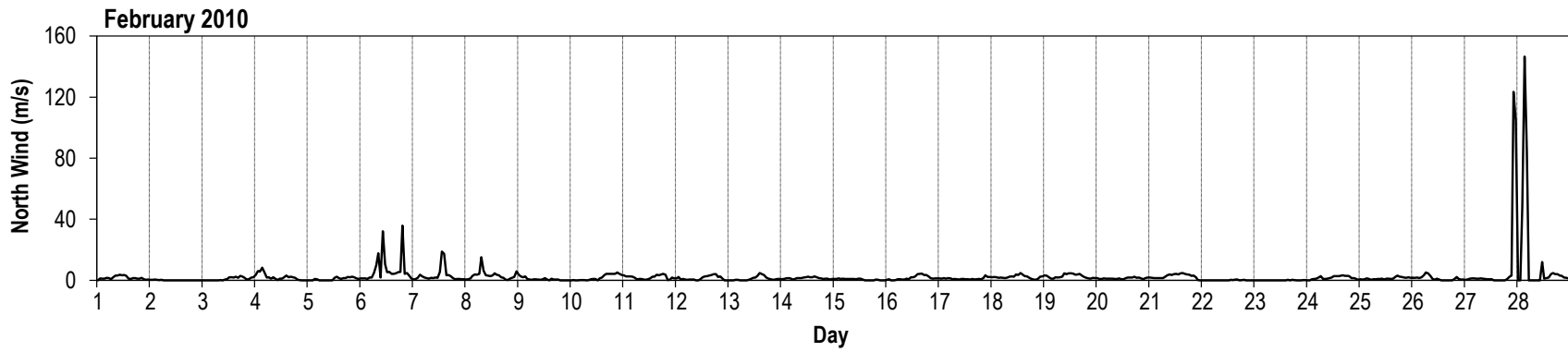
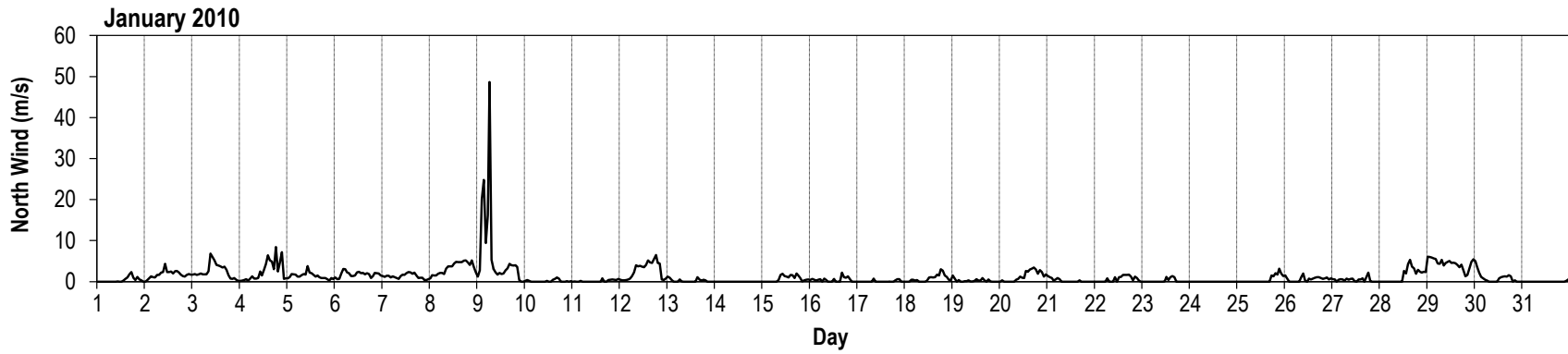
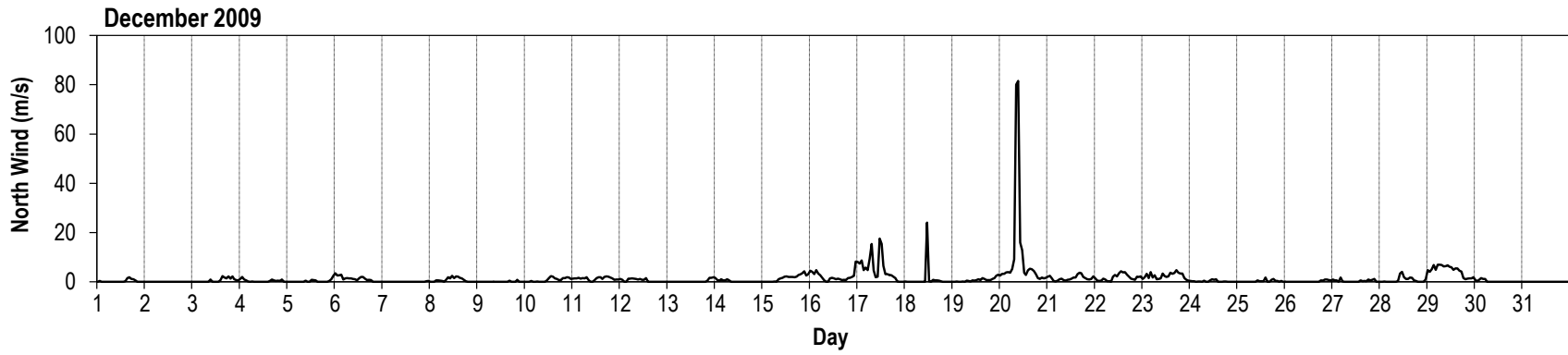

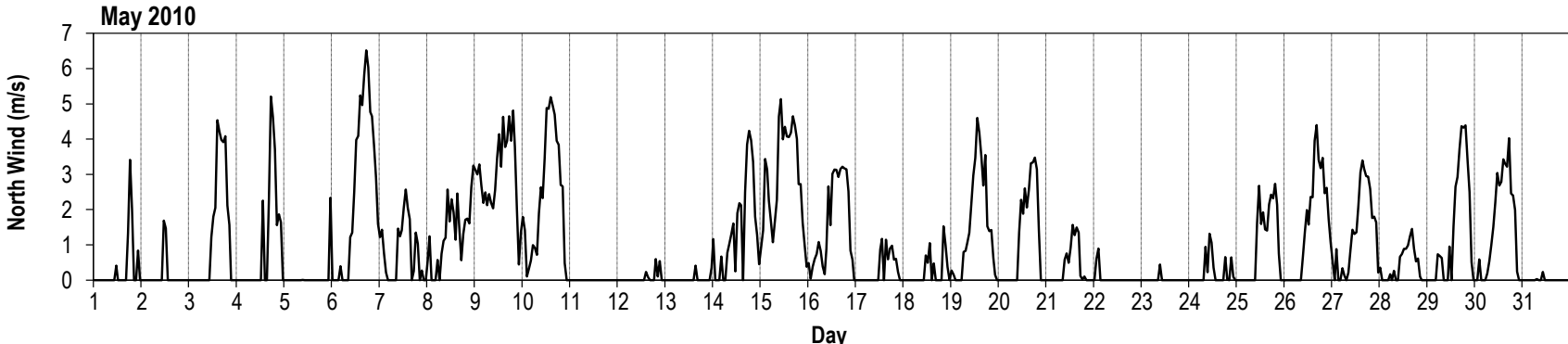
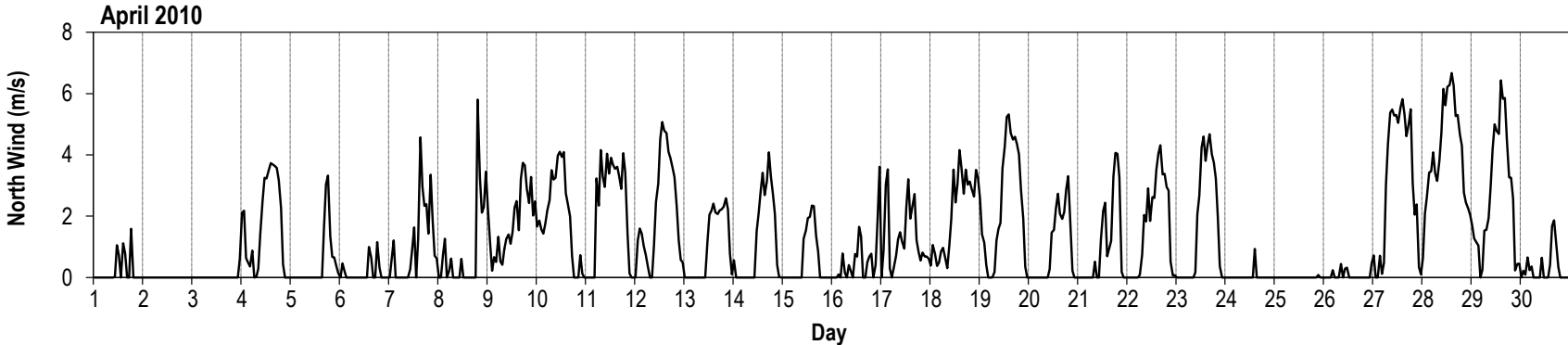
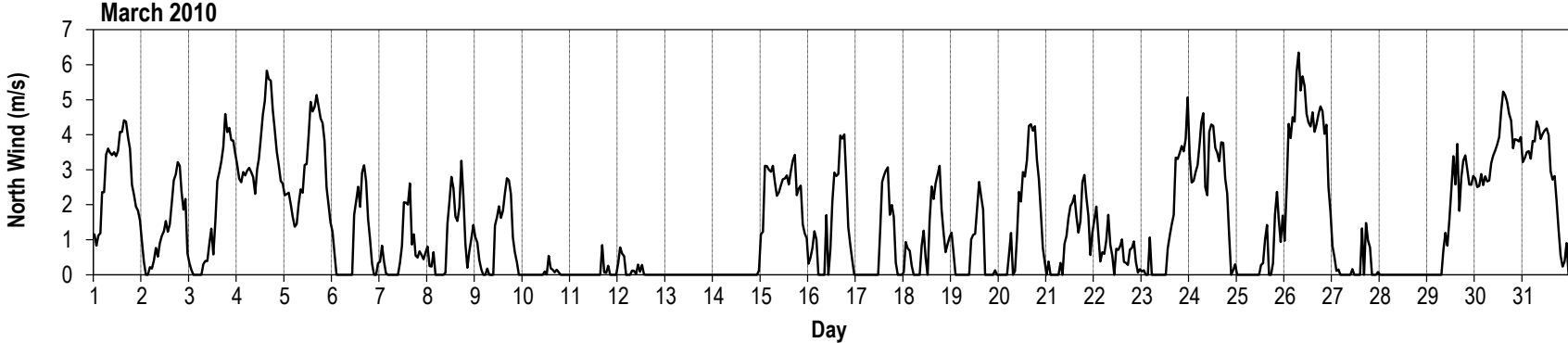

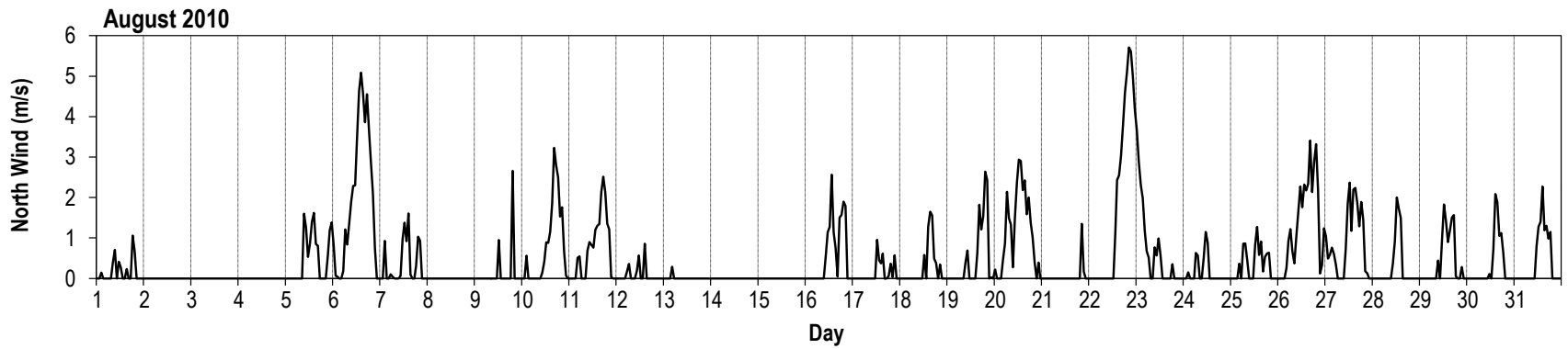
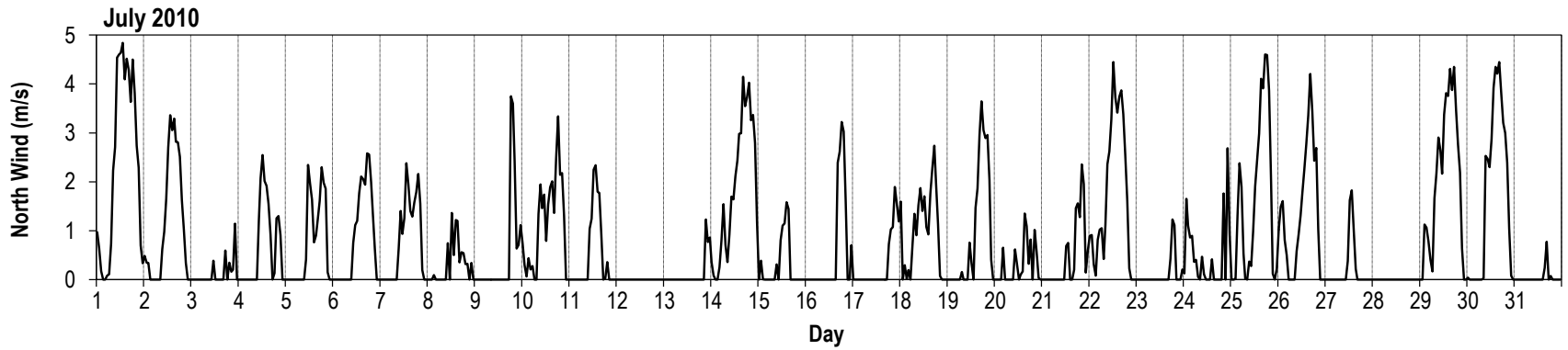
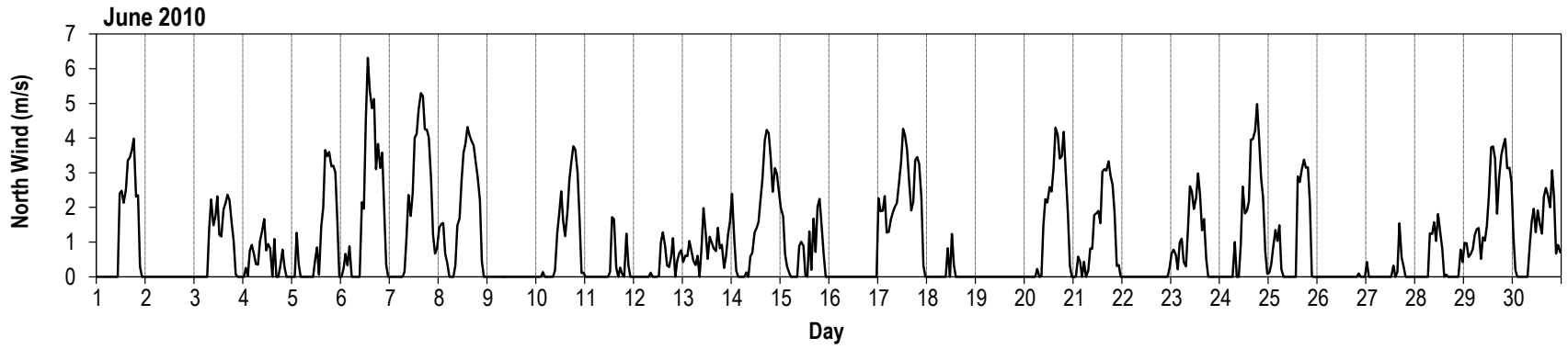

East wind (m/s)

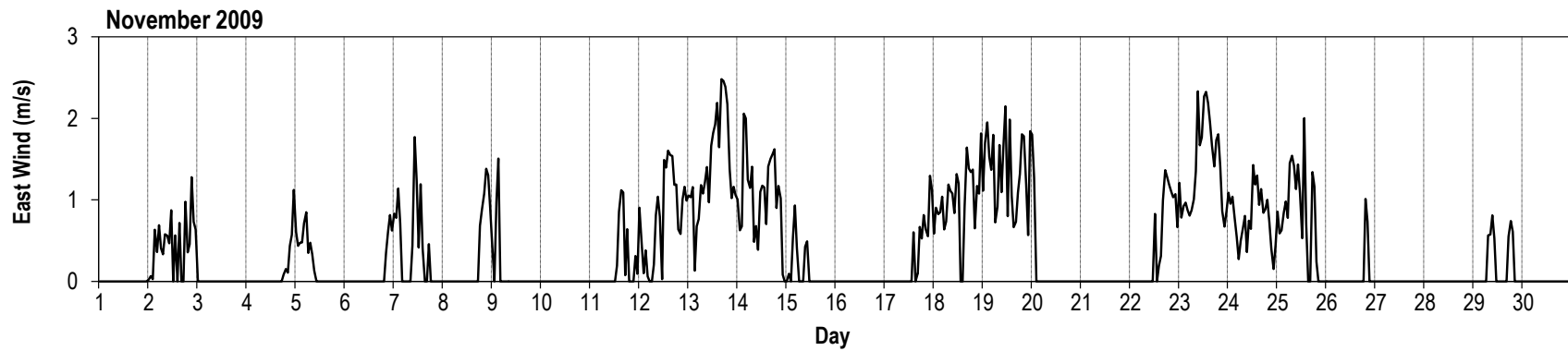
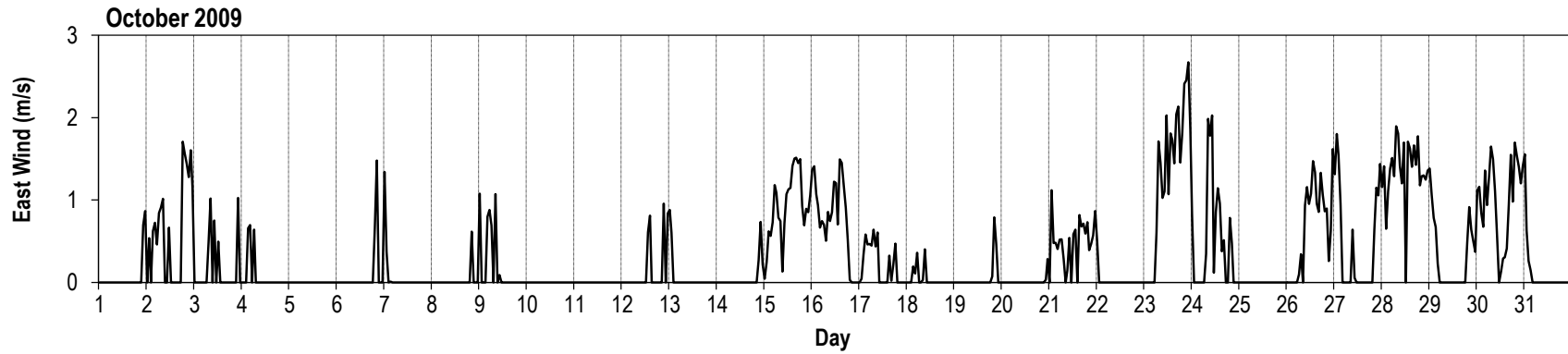
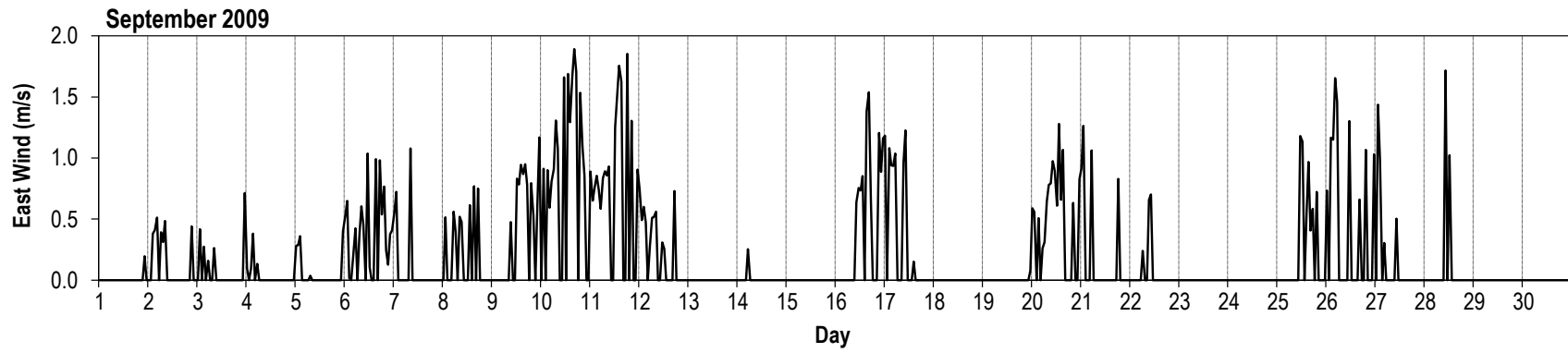

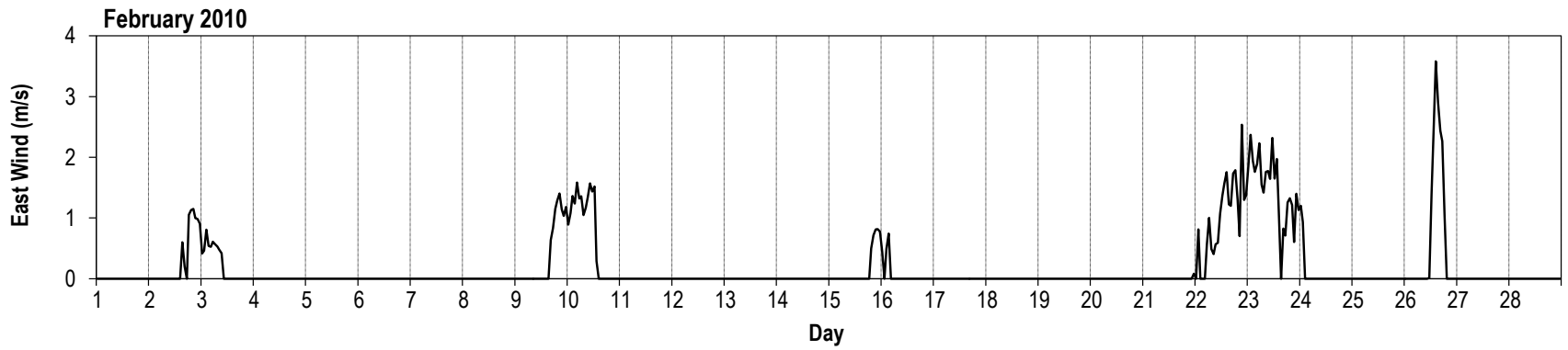
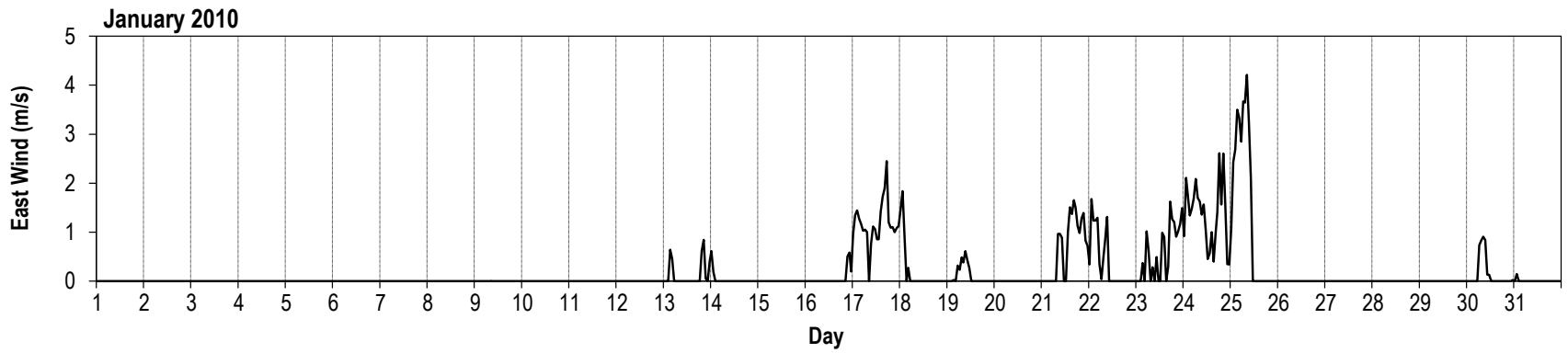
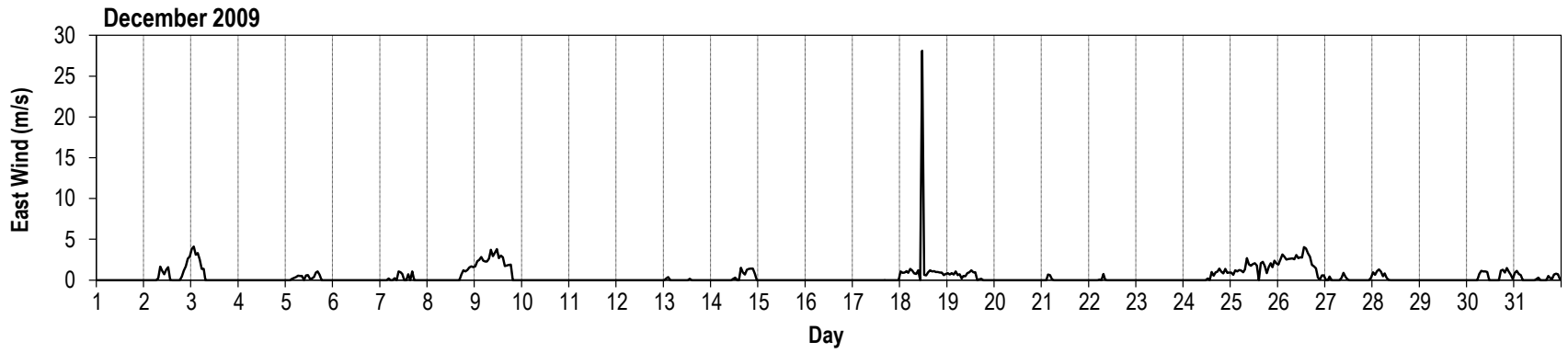

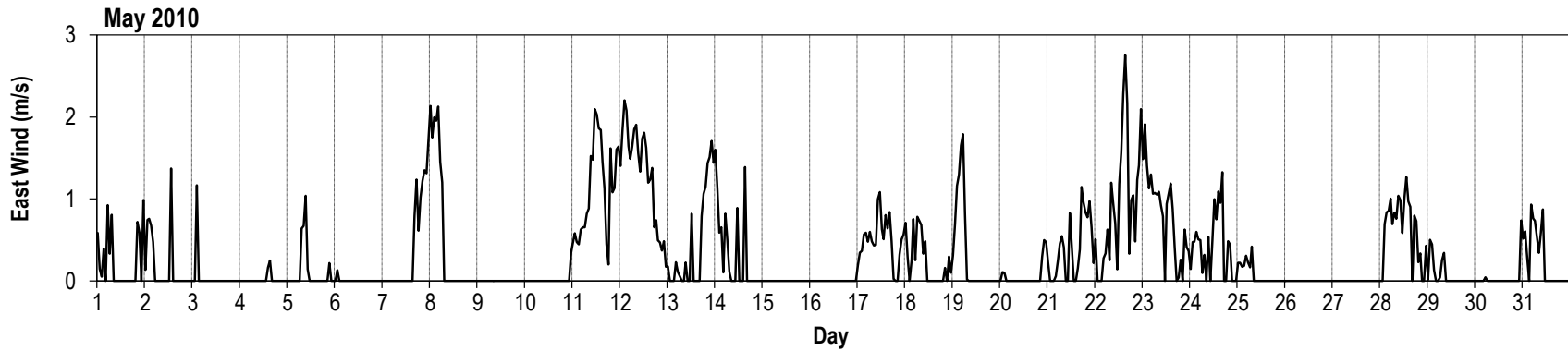
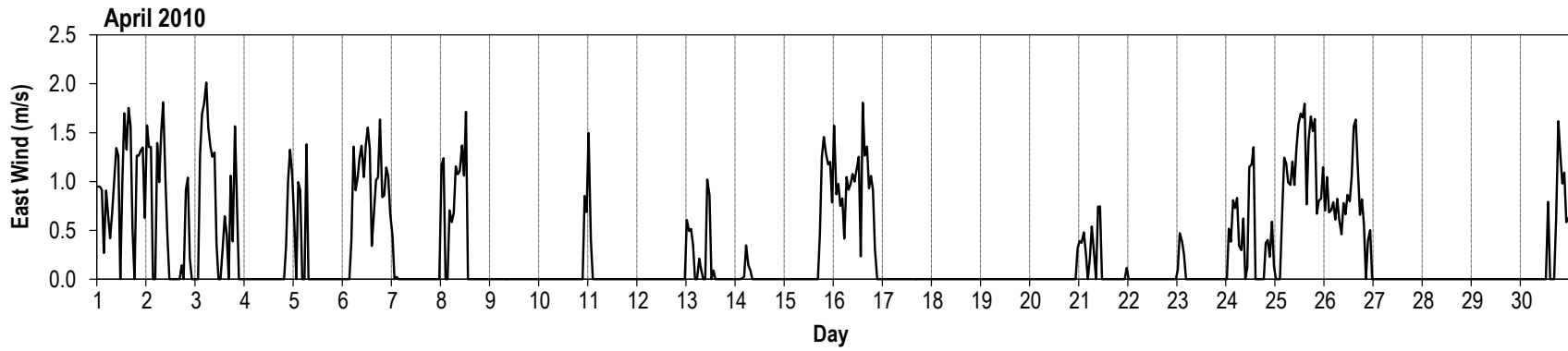
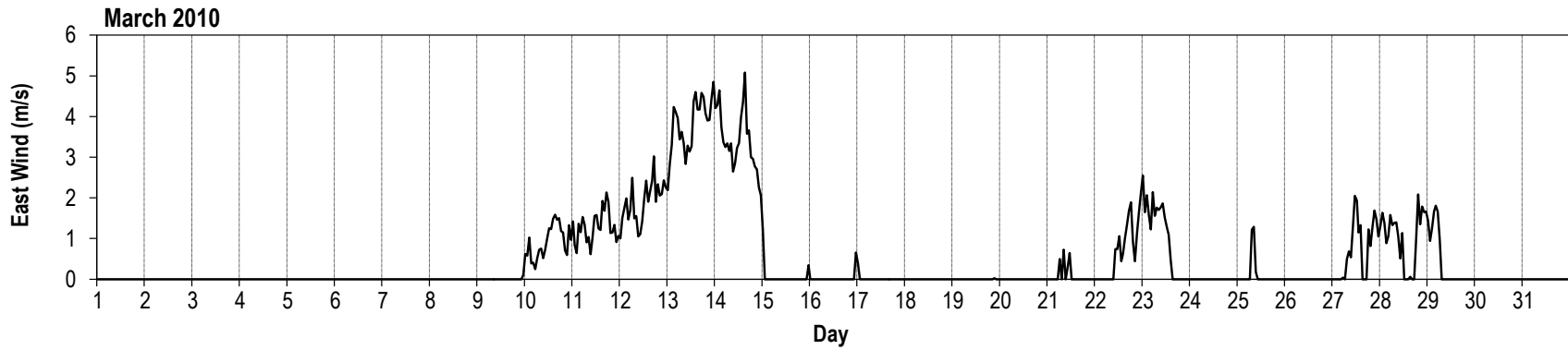

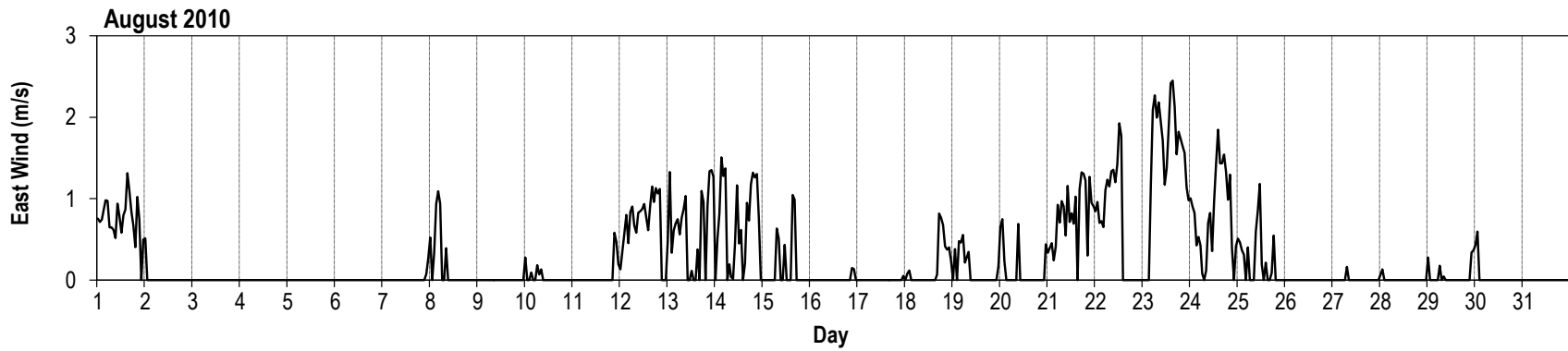
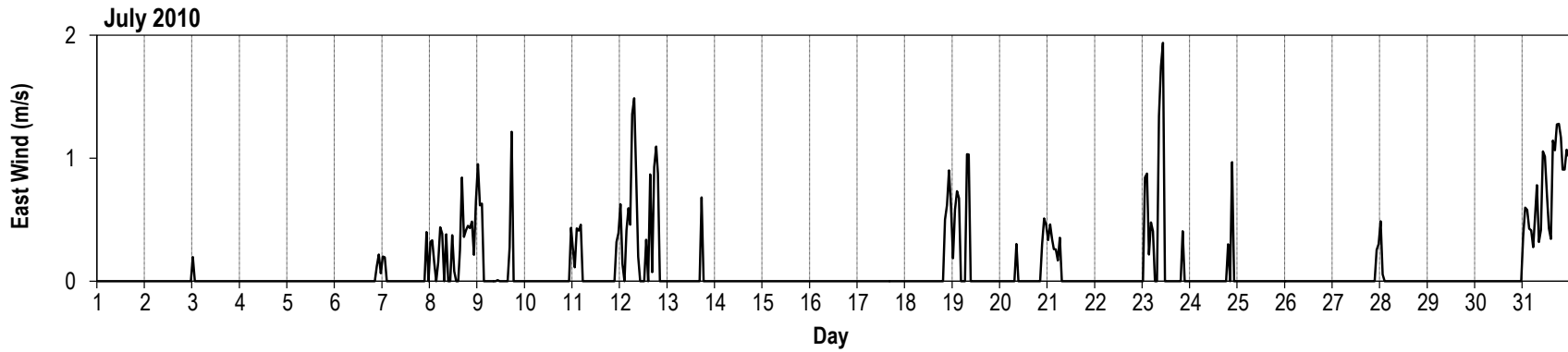
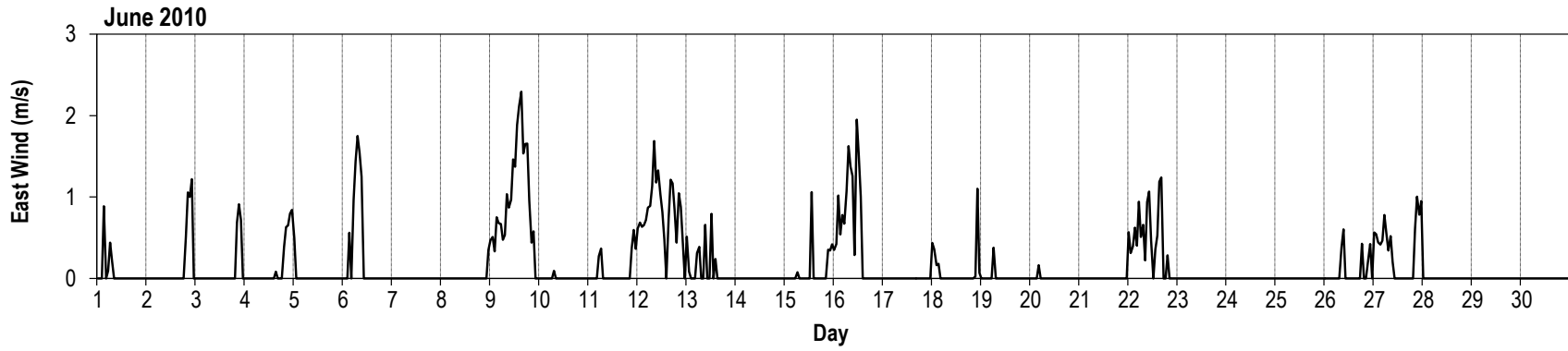

South wind (m/s)

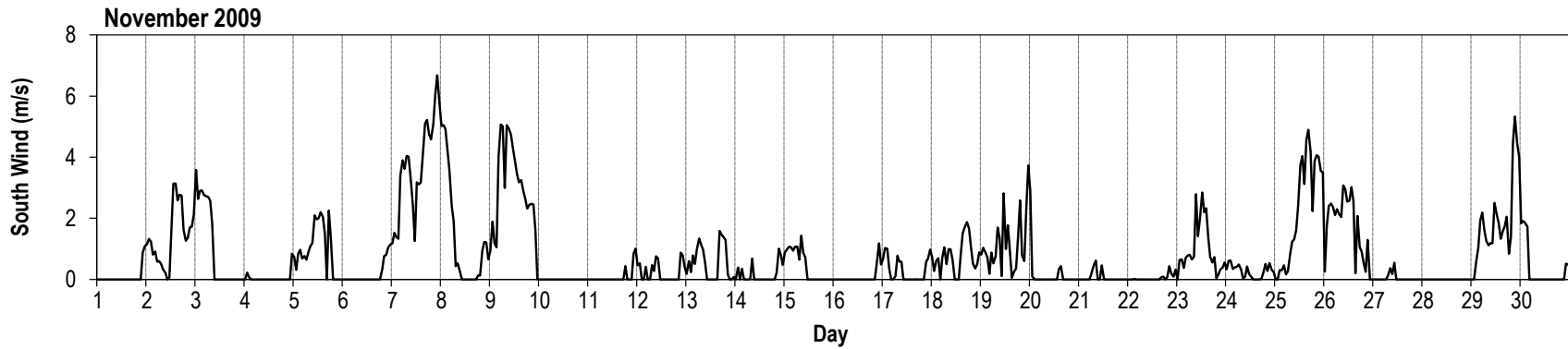
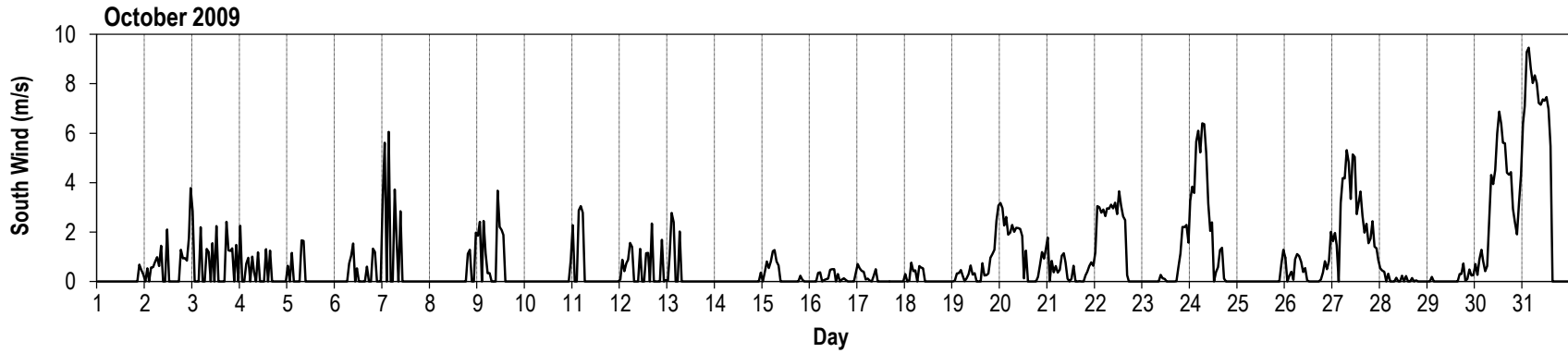
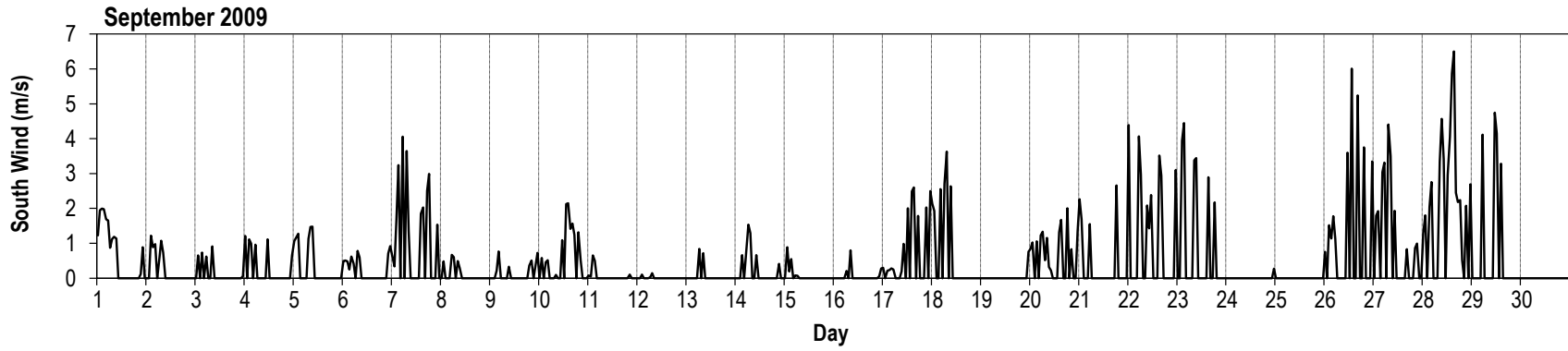

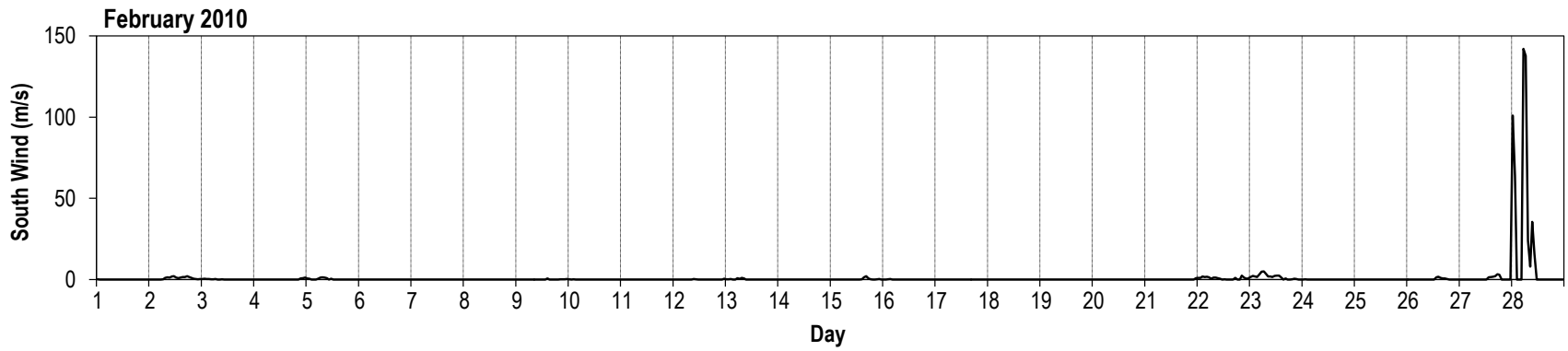
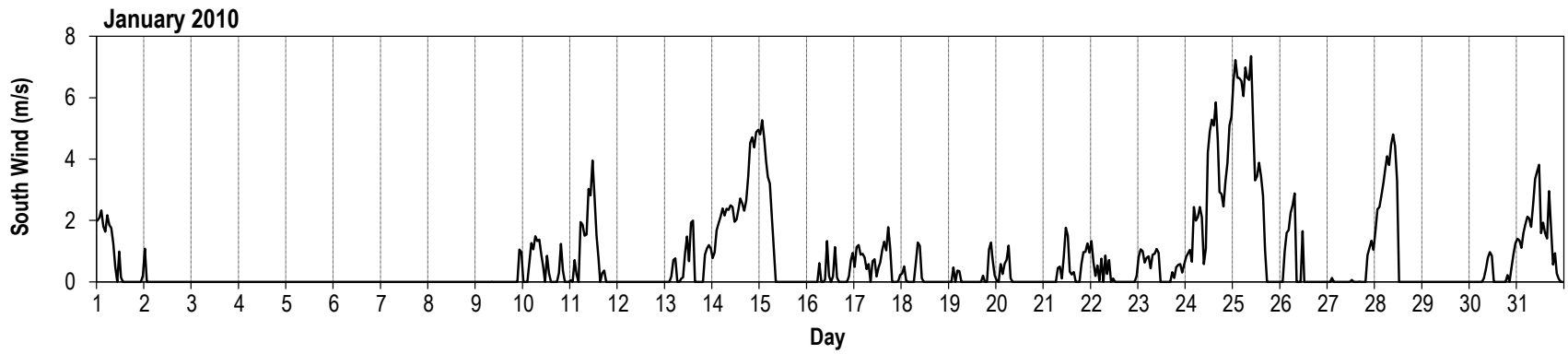
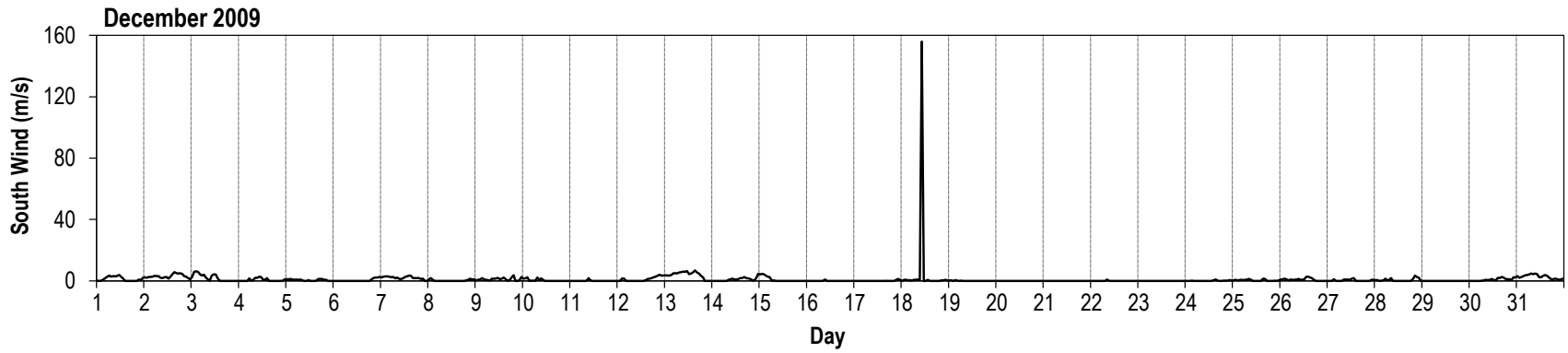

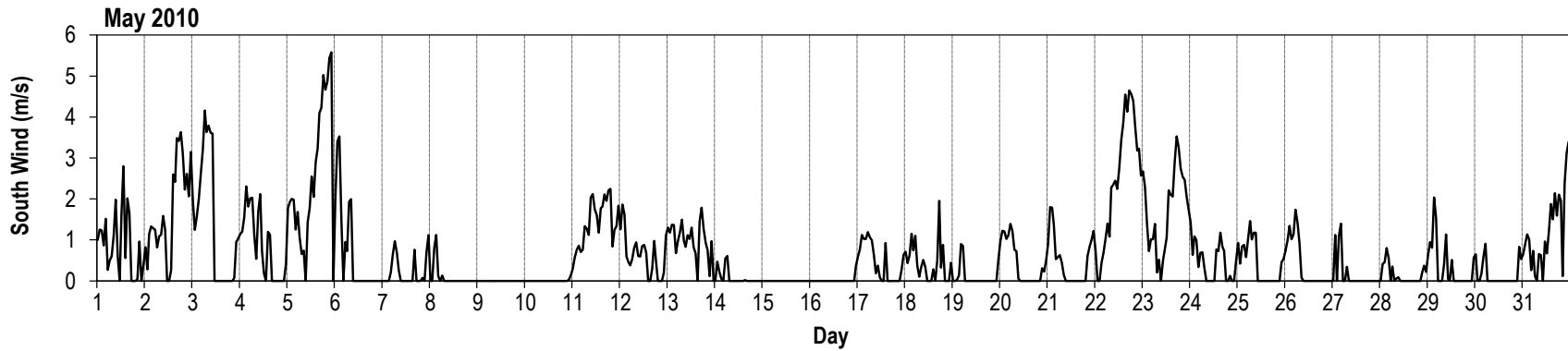
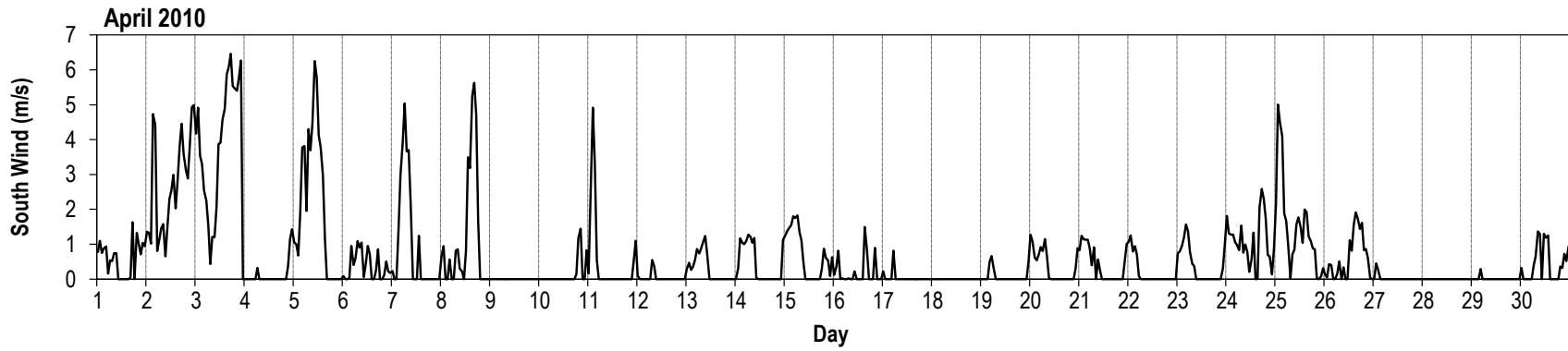
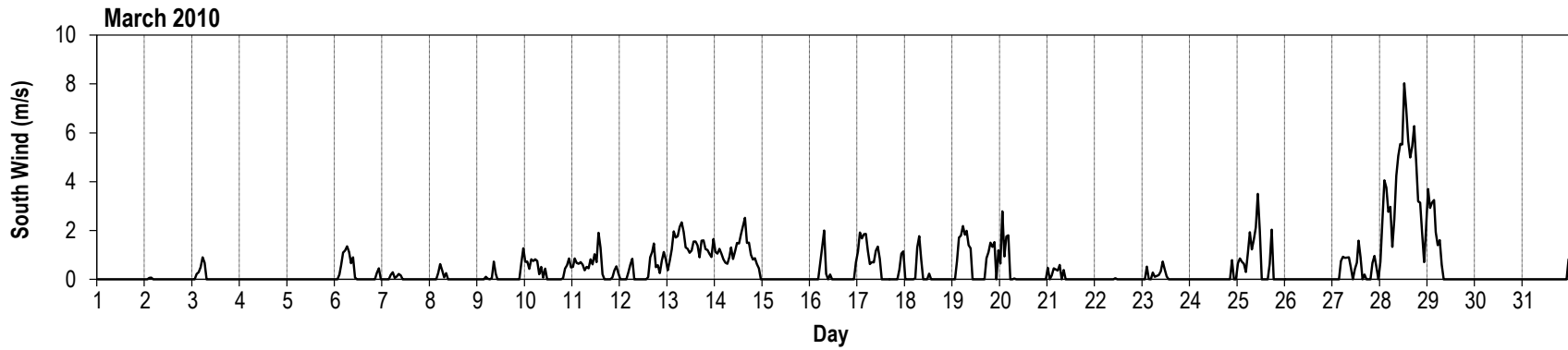

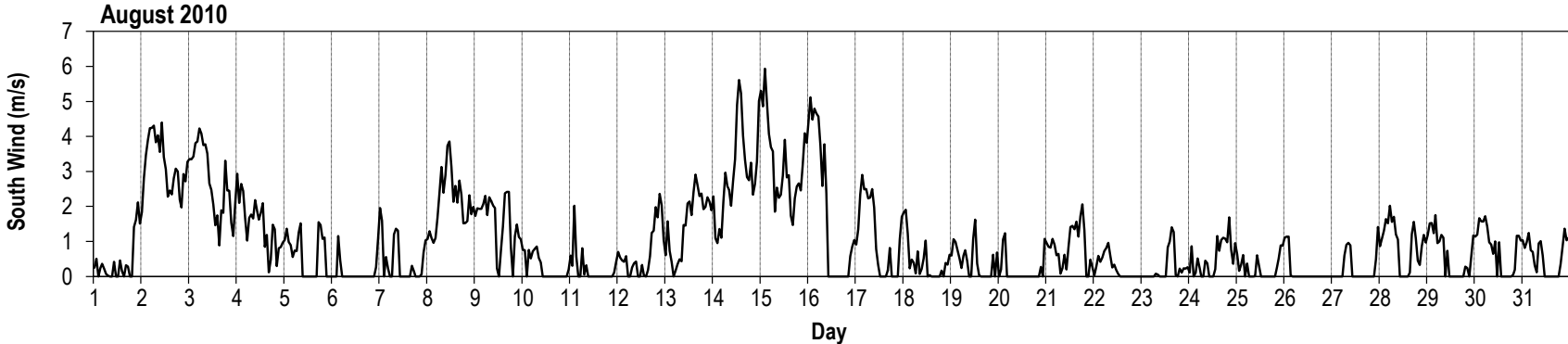
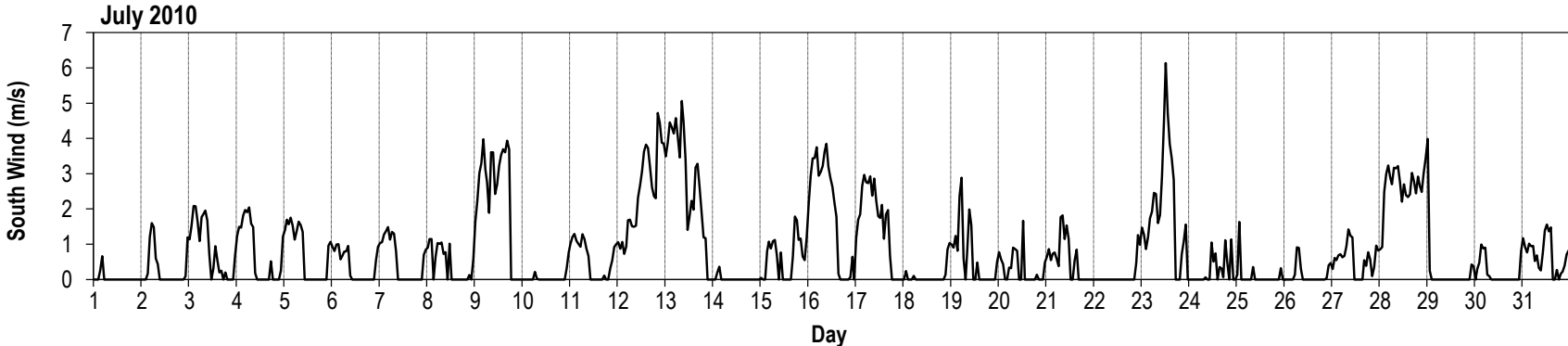
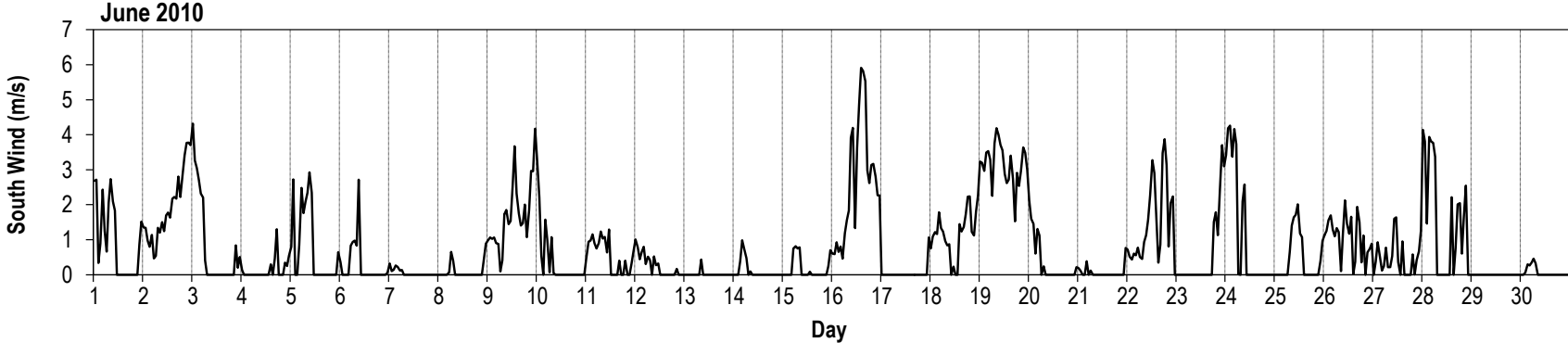

West wind (m/s)

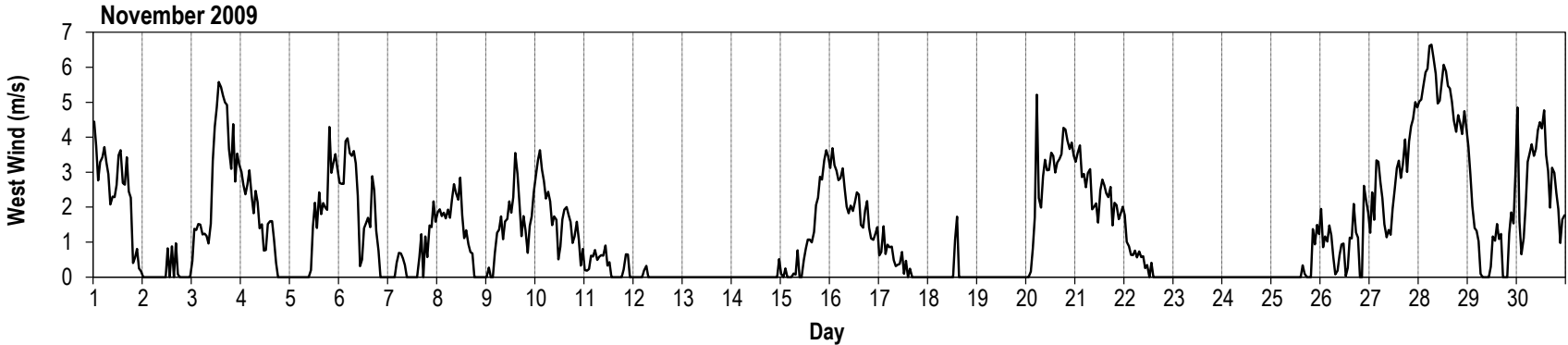
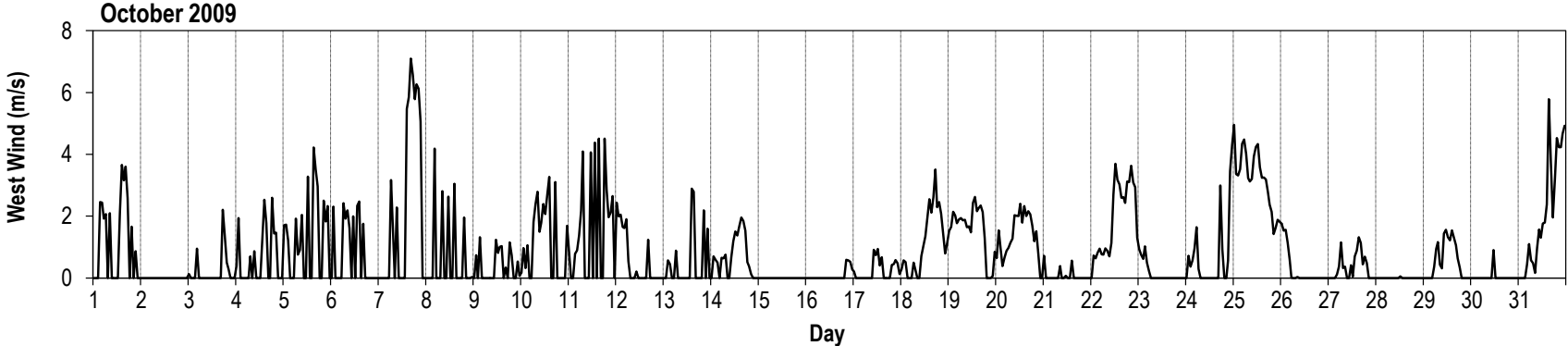
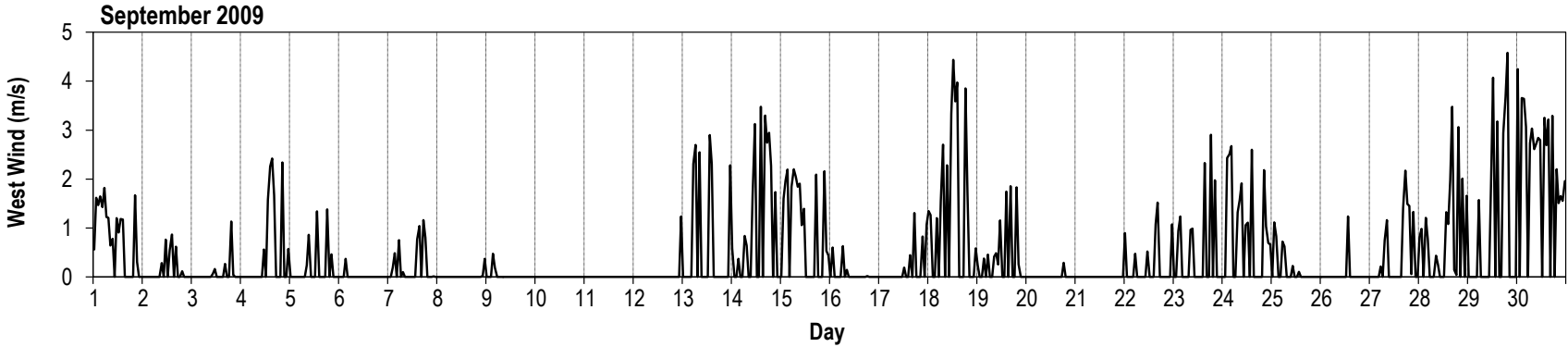

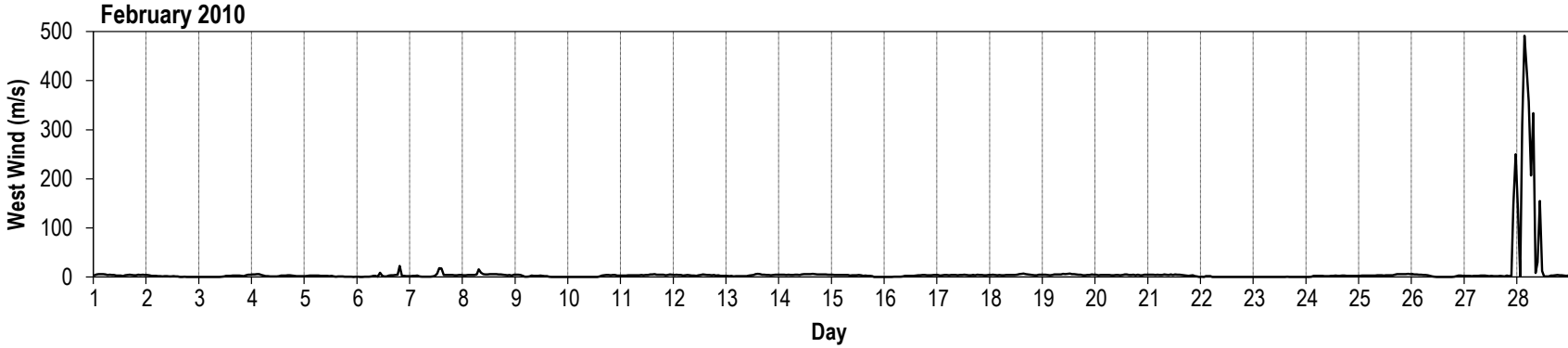
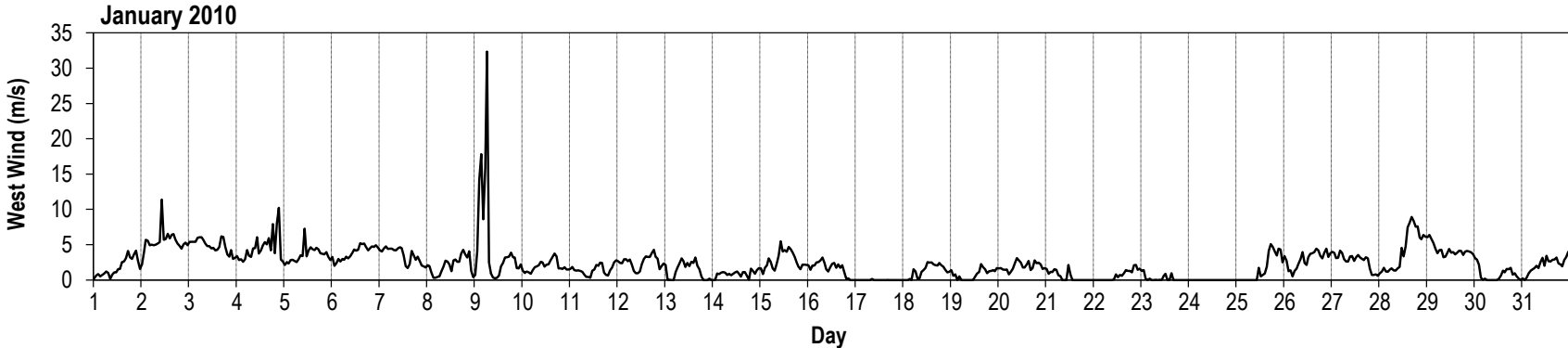
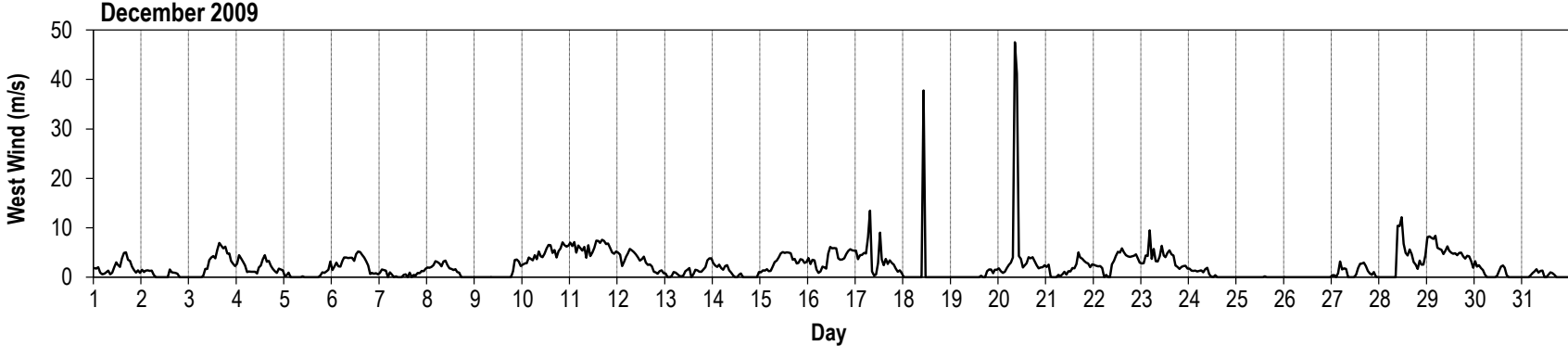

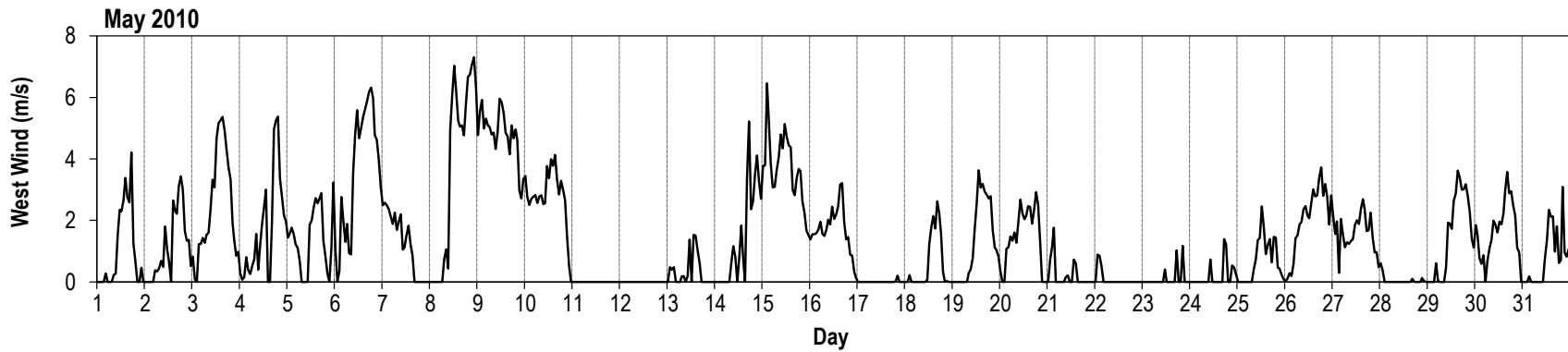
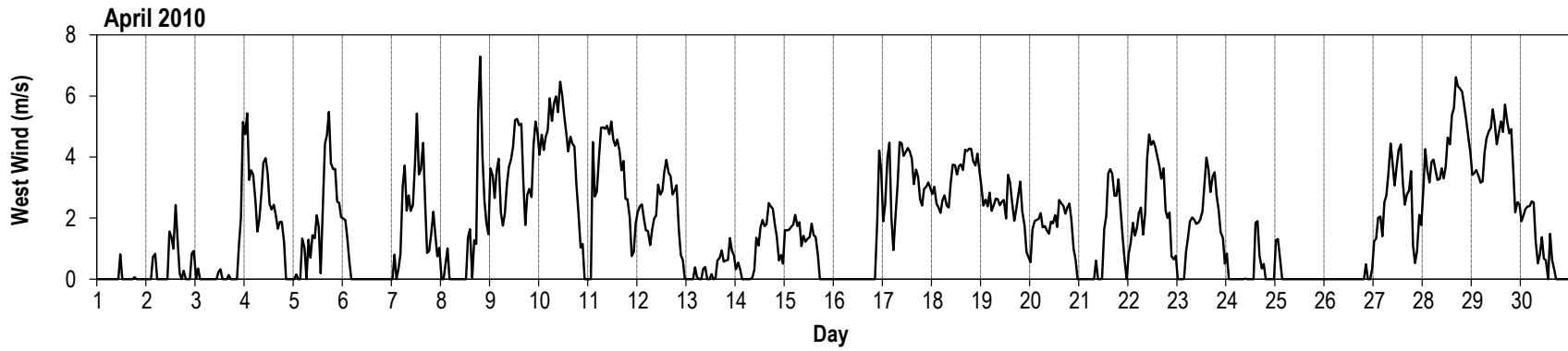
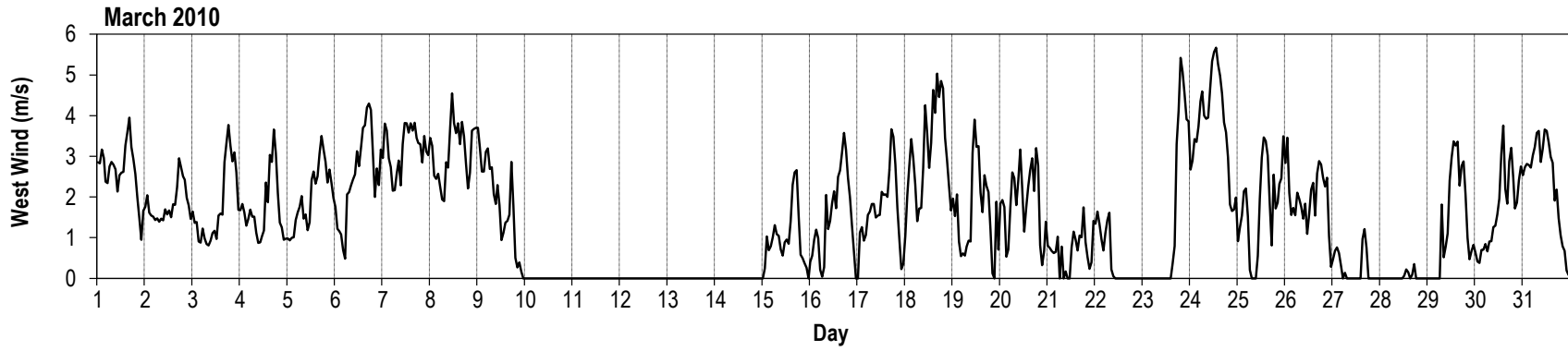

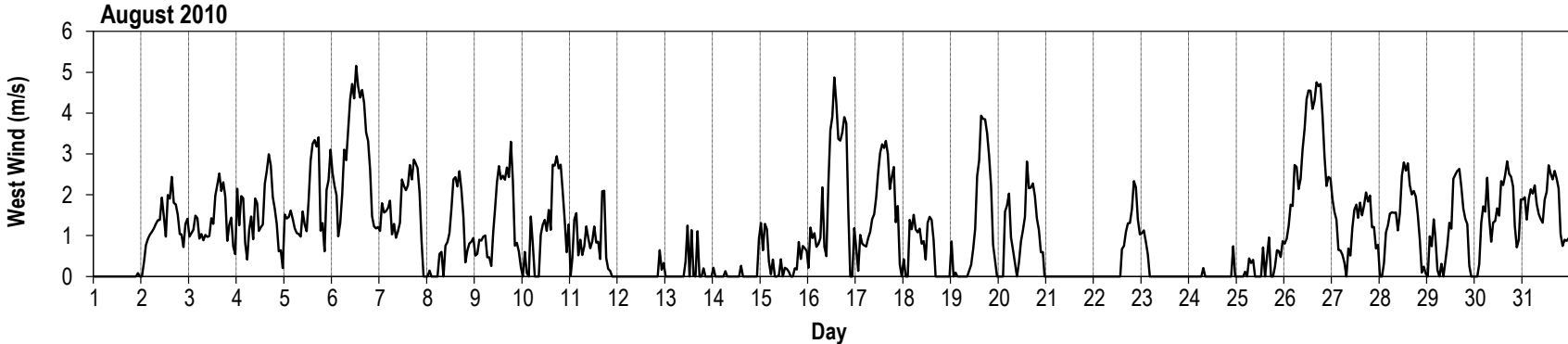
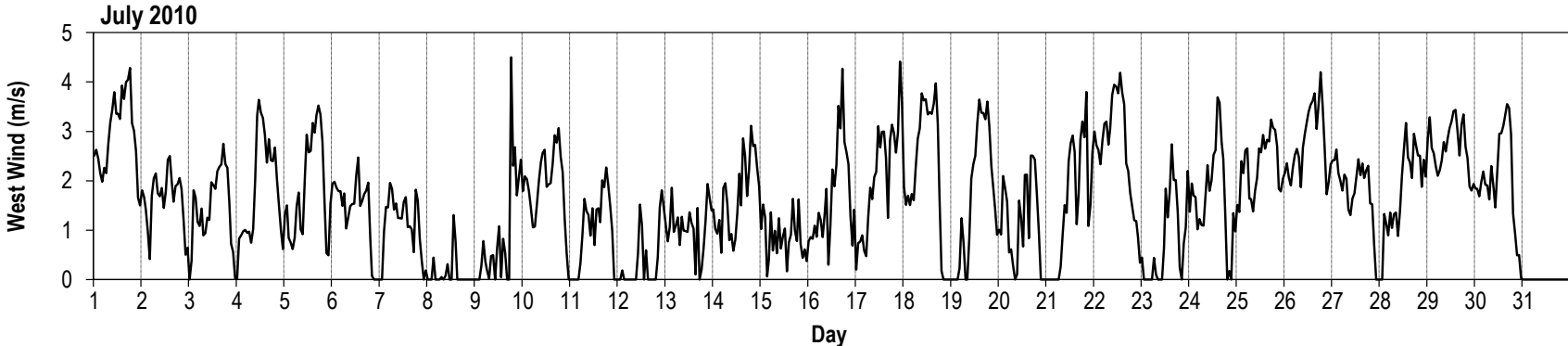
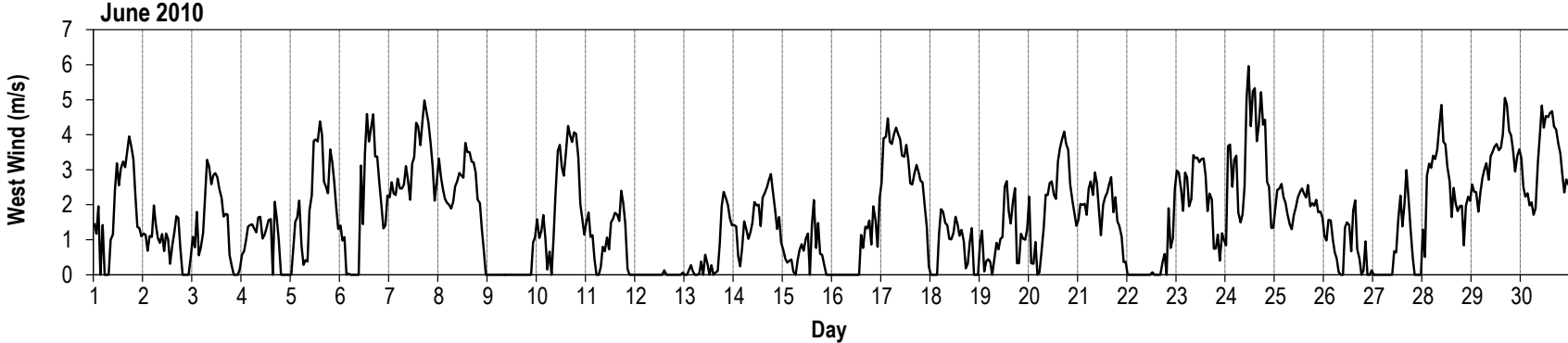

Appendix G: Rain

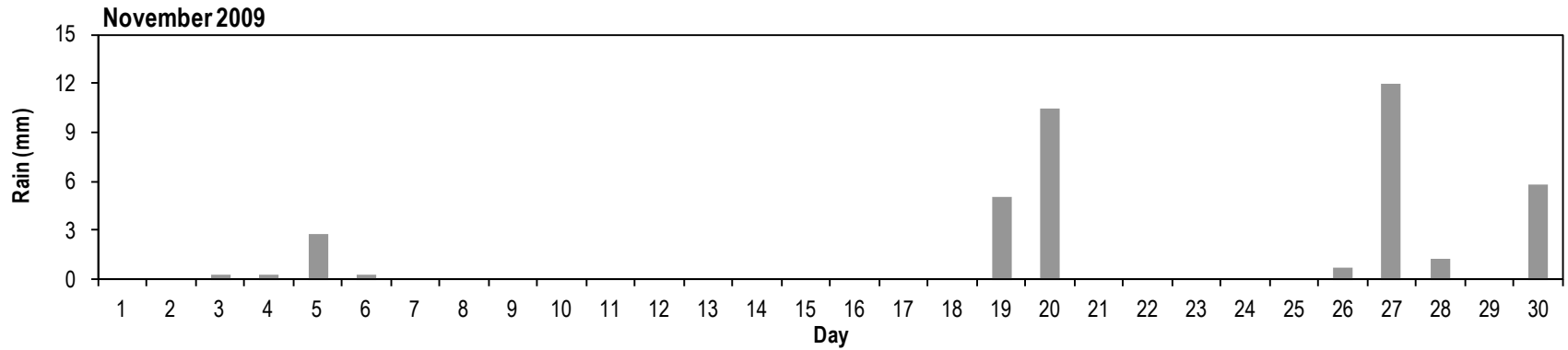
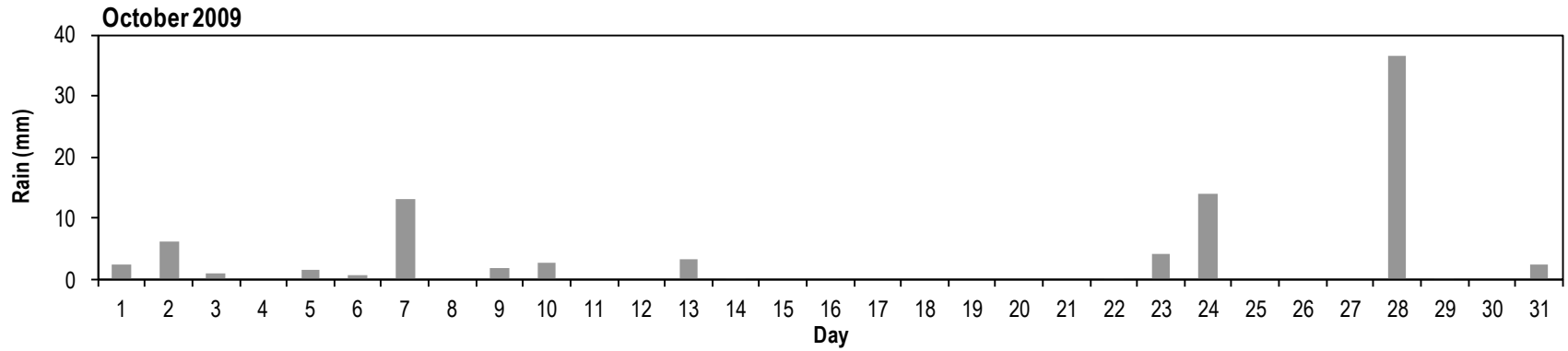
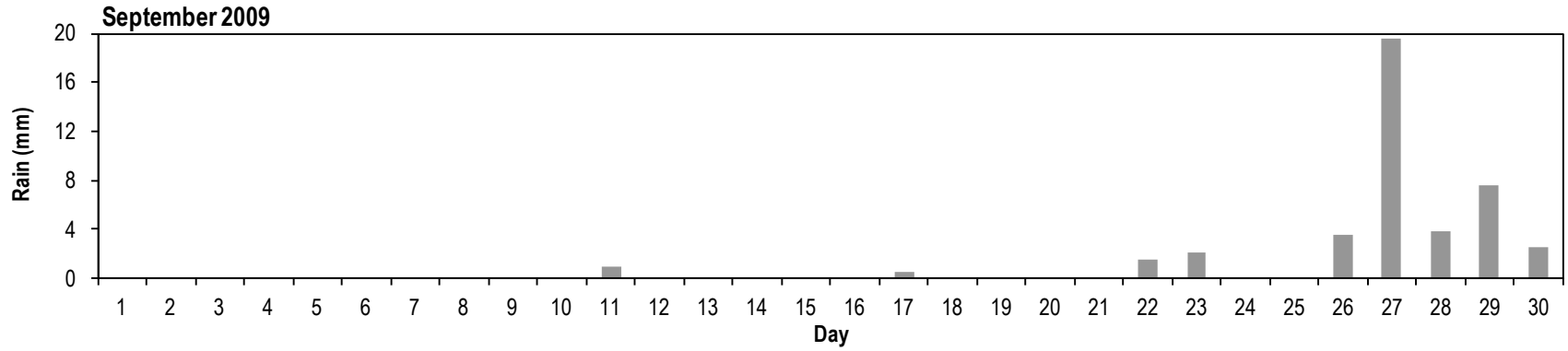

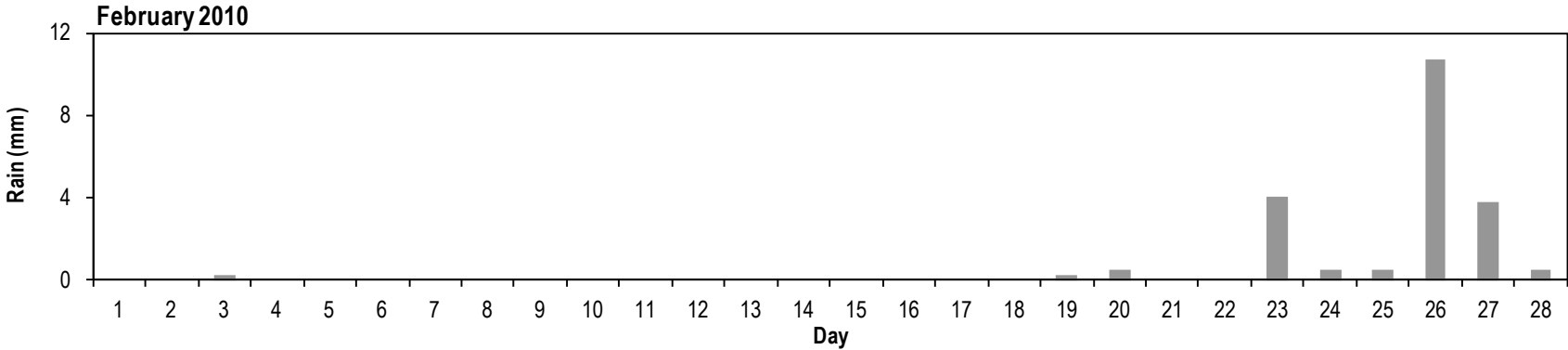
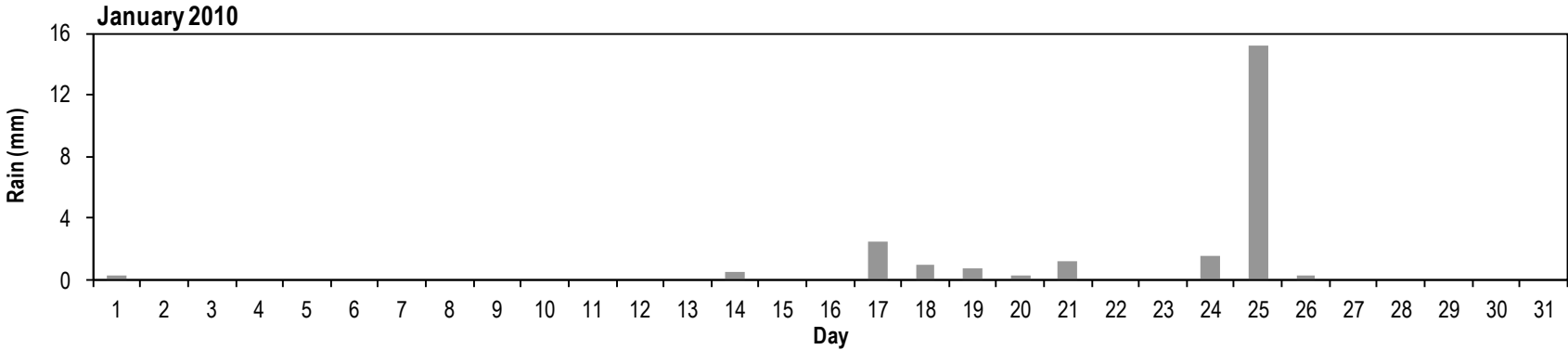
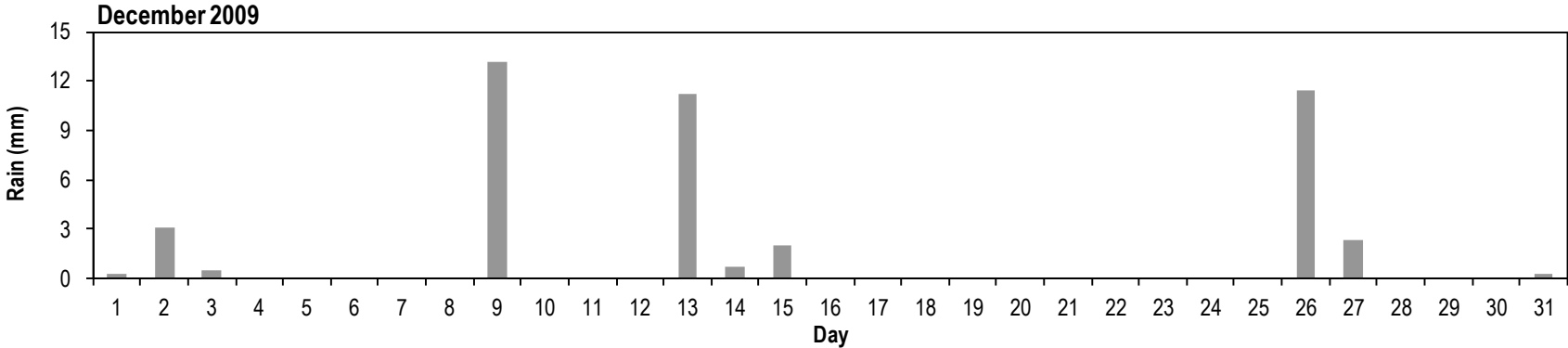

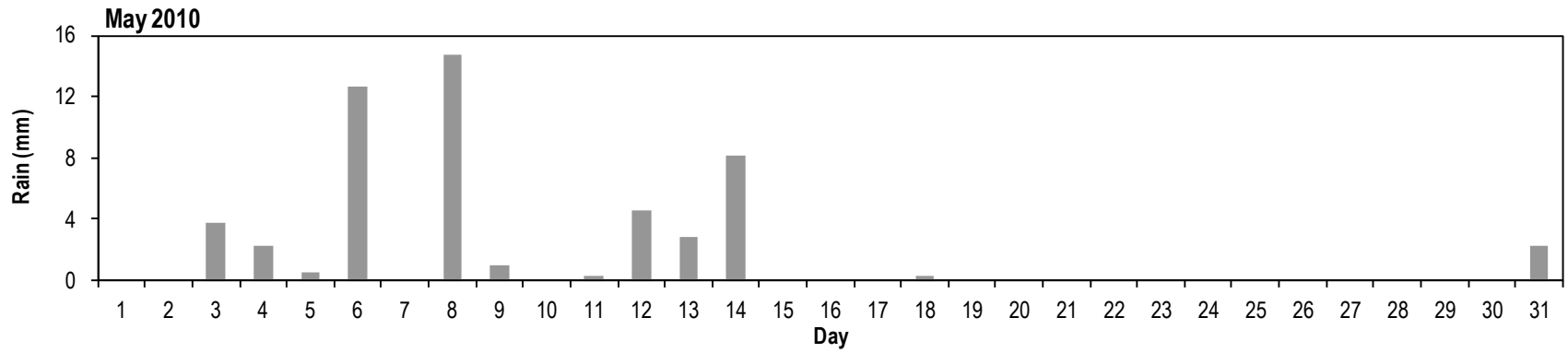
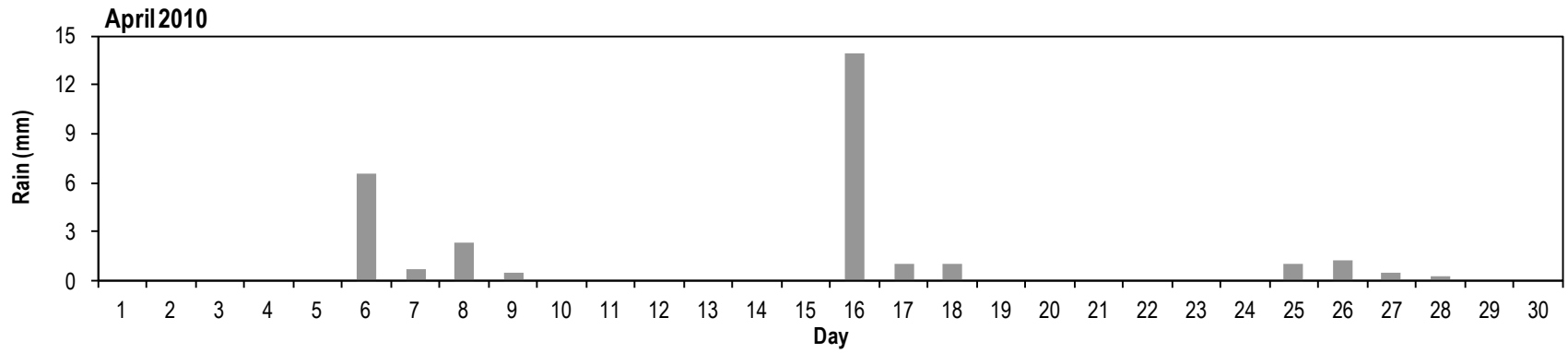
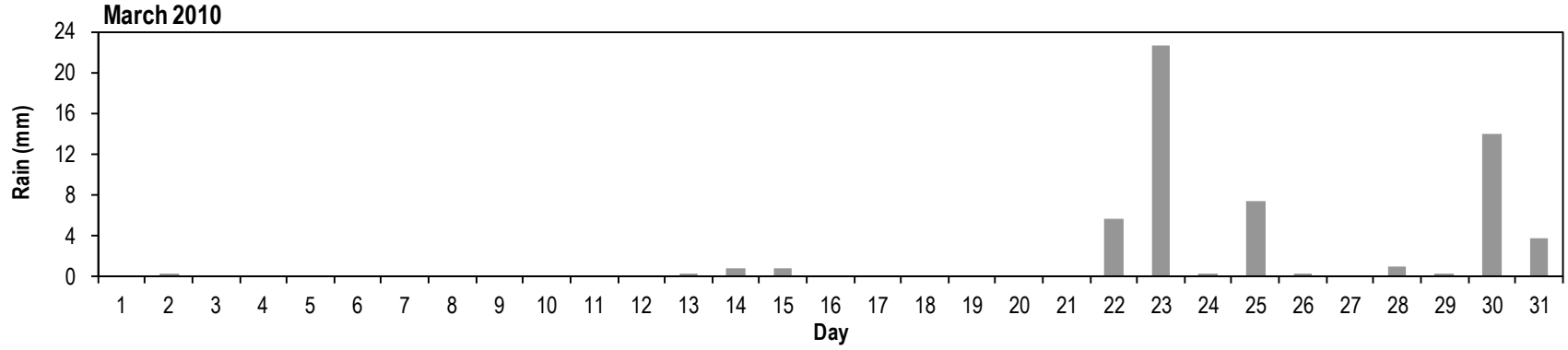

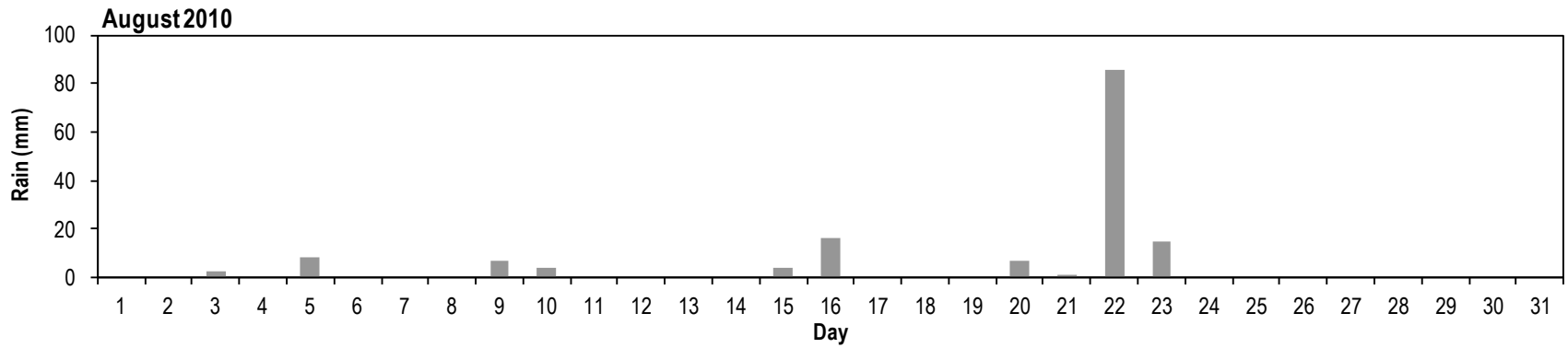
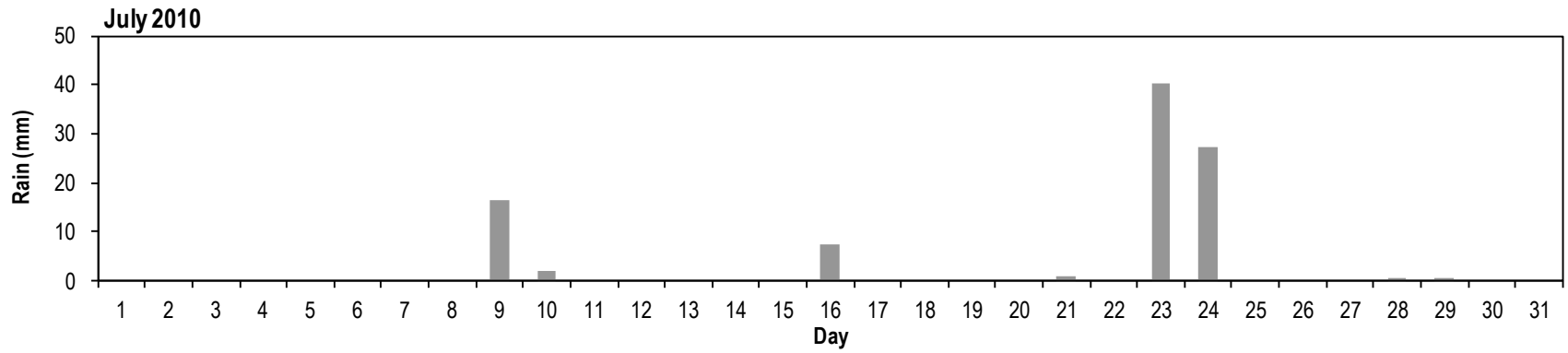
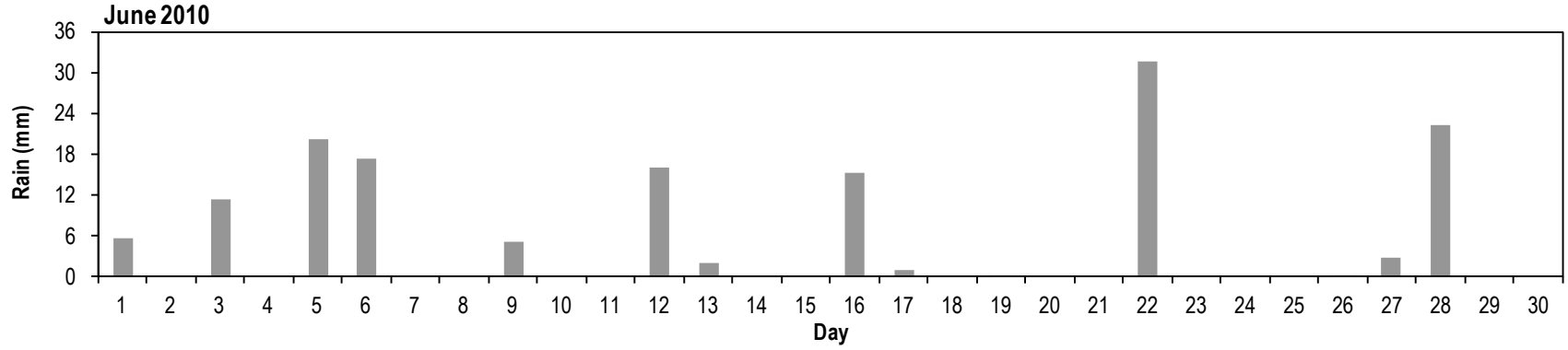

Appendix H: Pressure Differential

Pressure differential (Pa) across the north side of the test hut

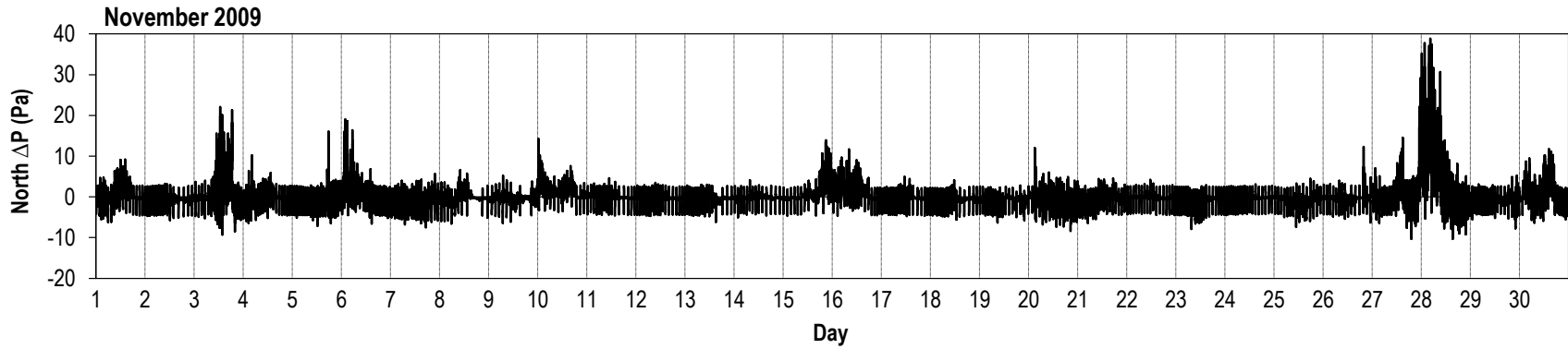
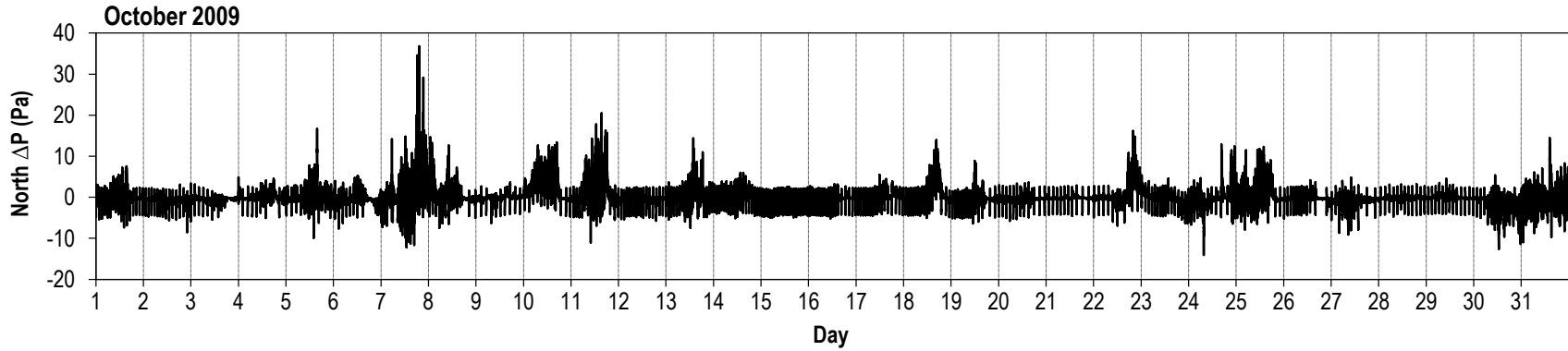
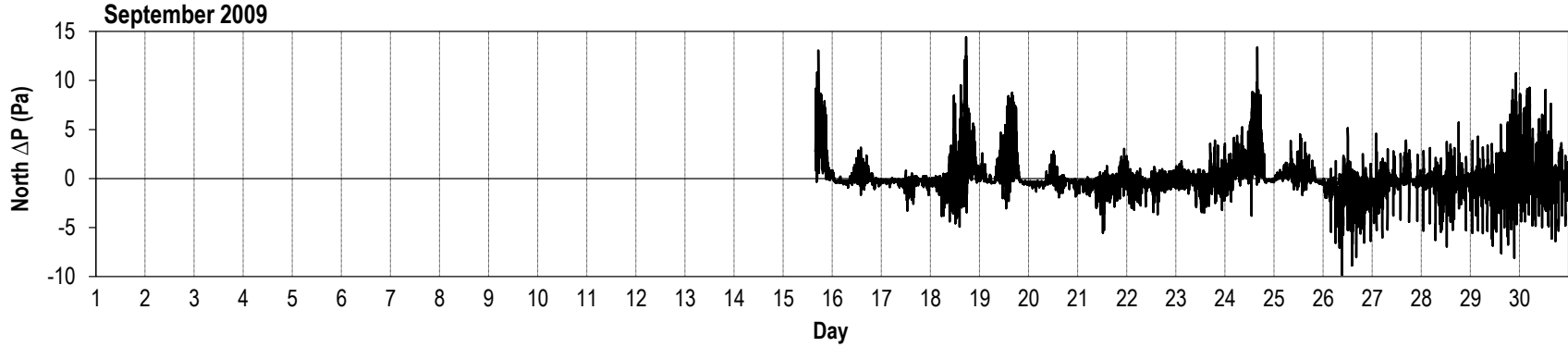

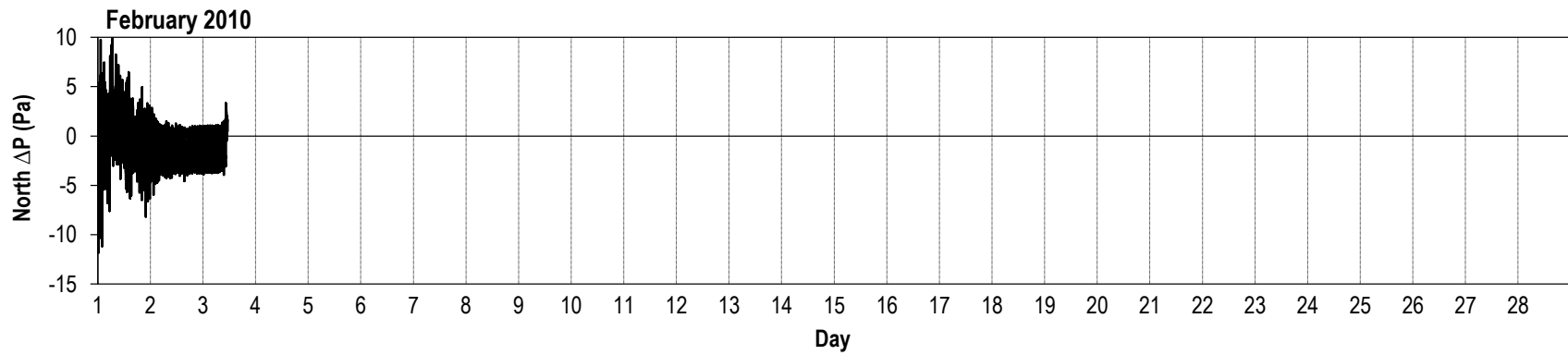
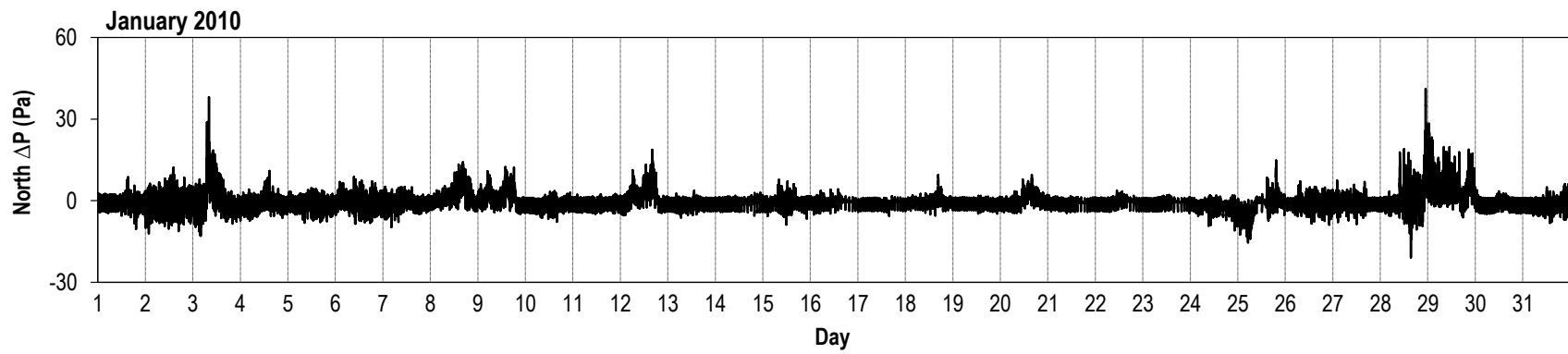
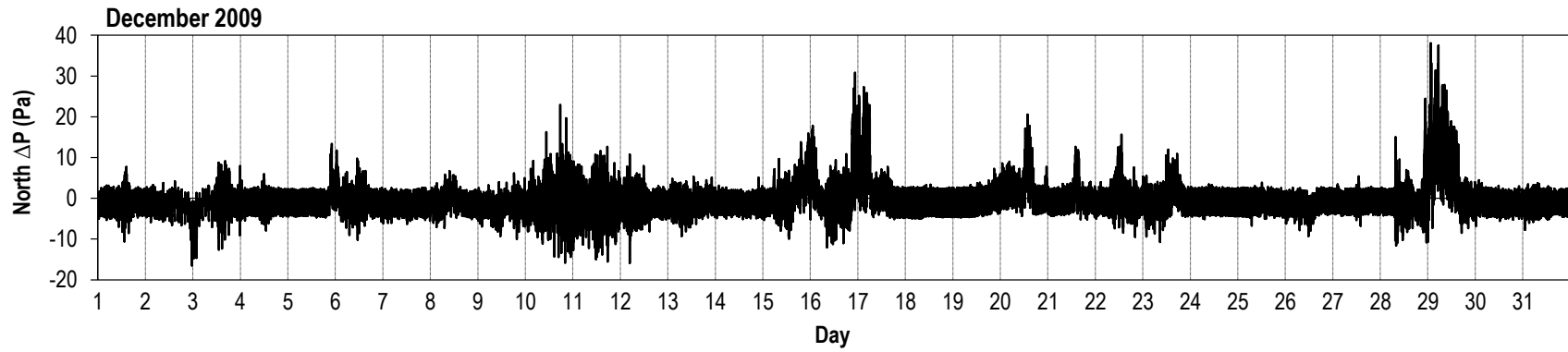

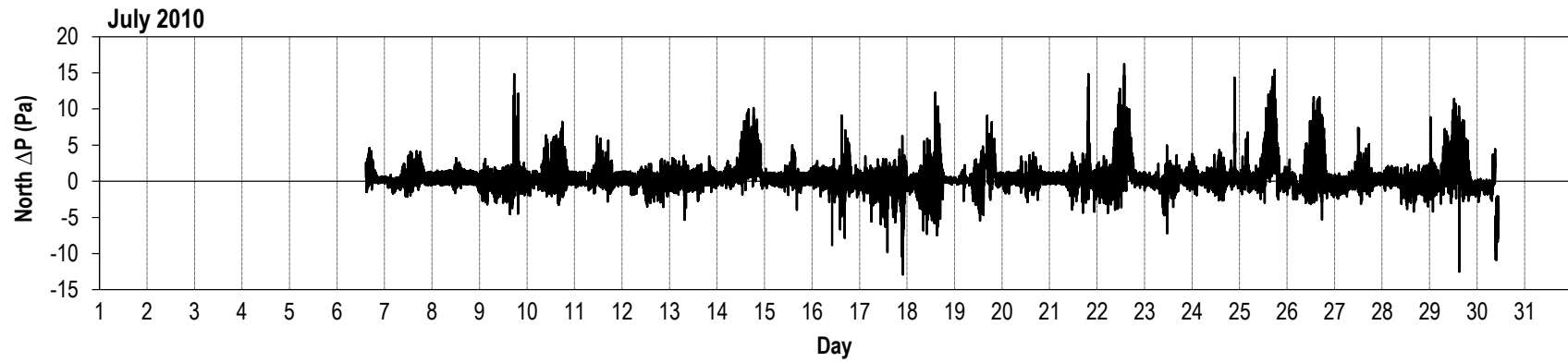

Notes:

- a. Data missing due to equipment malfunction.
- b. July measurements obtained while Syracuse University pressurized the test hut to characterize the air leakage of wall panels are not included in the graph above.

Pressure differential (Pa) across the east side of the test hut

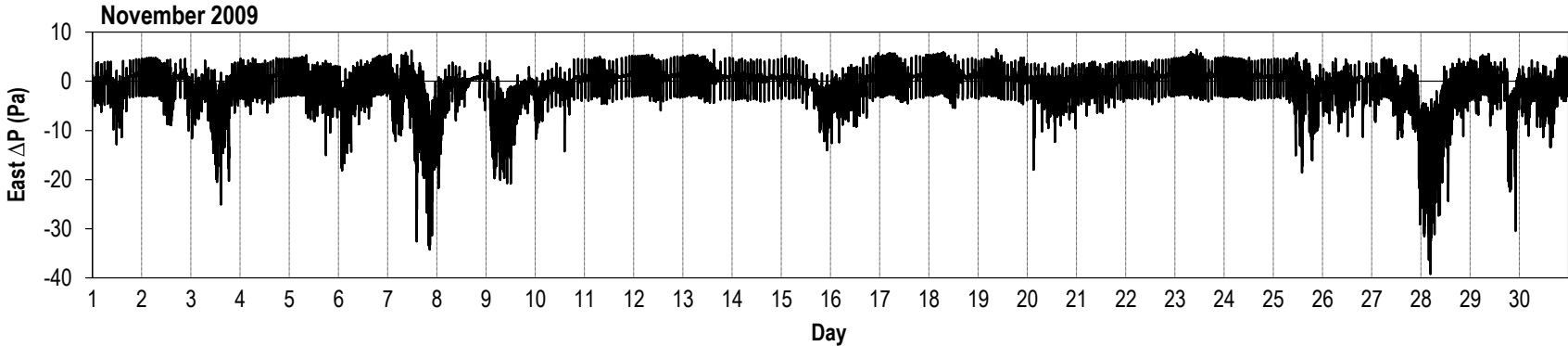
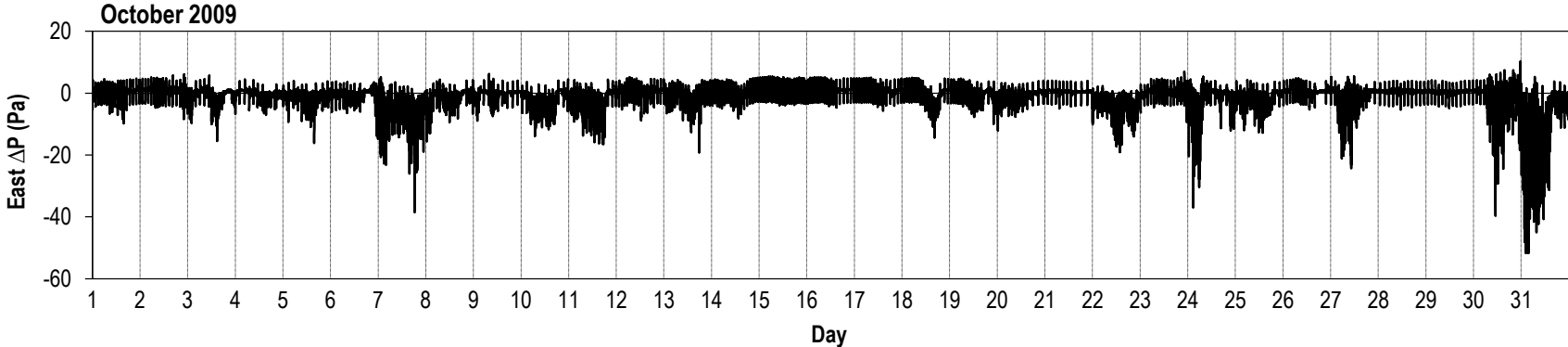
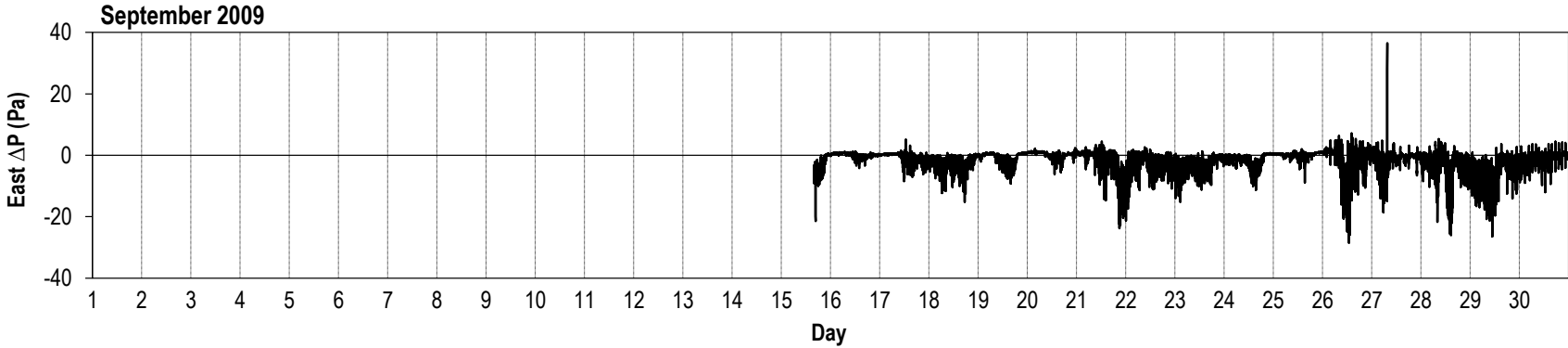

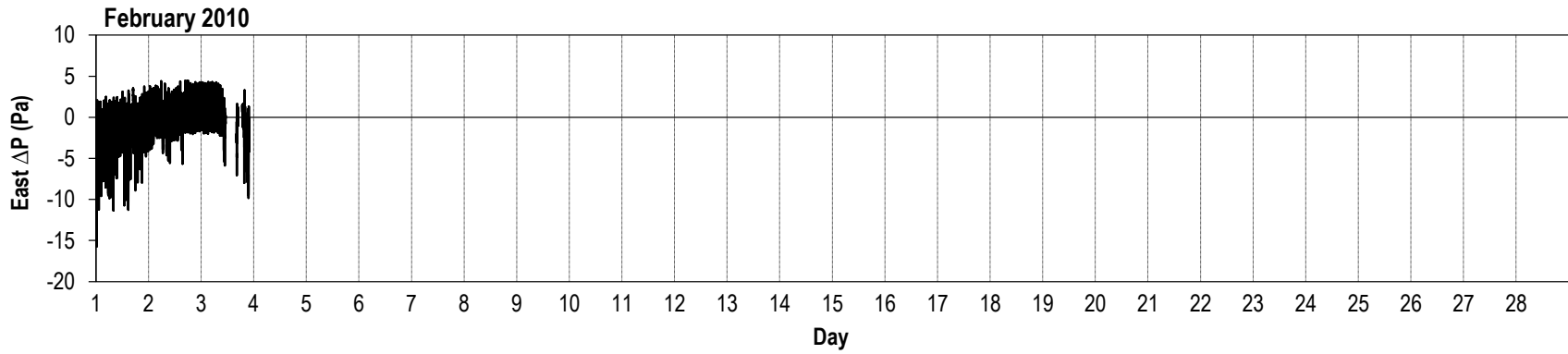
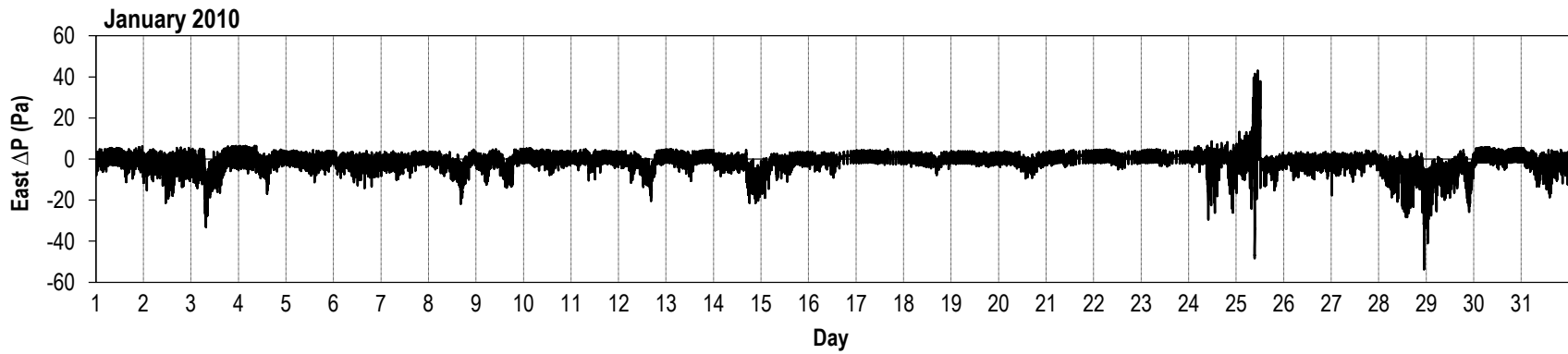
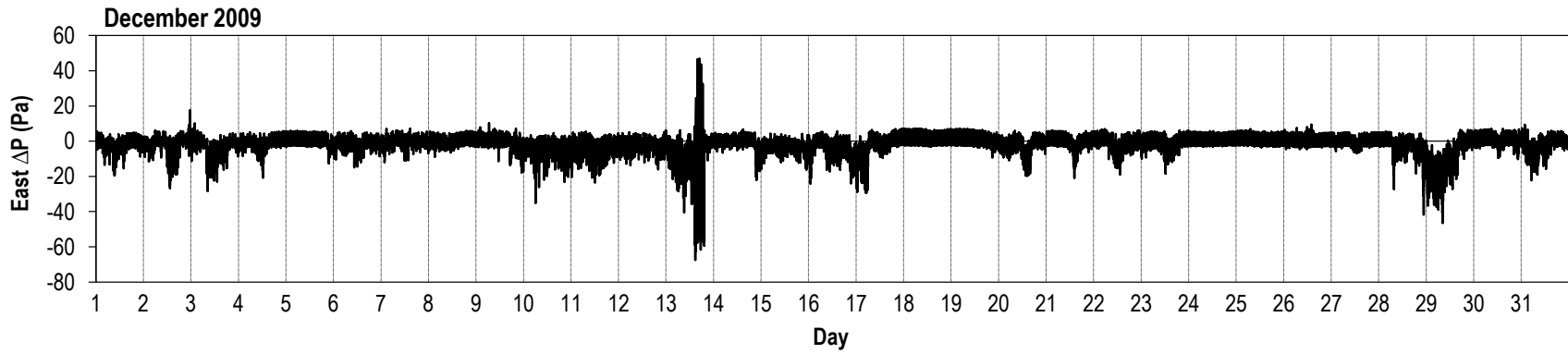

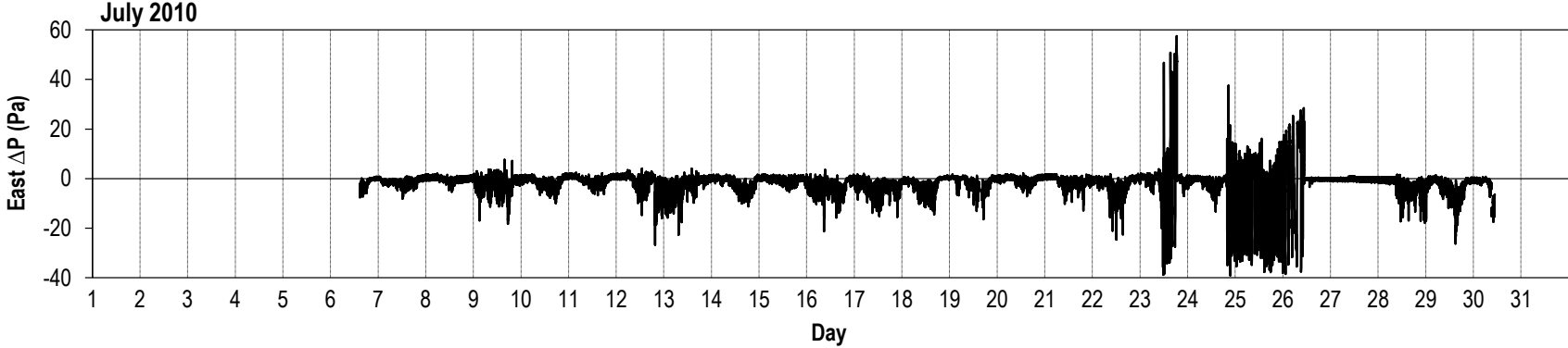
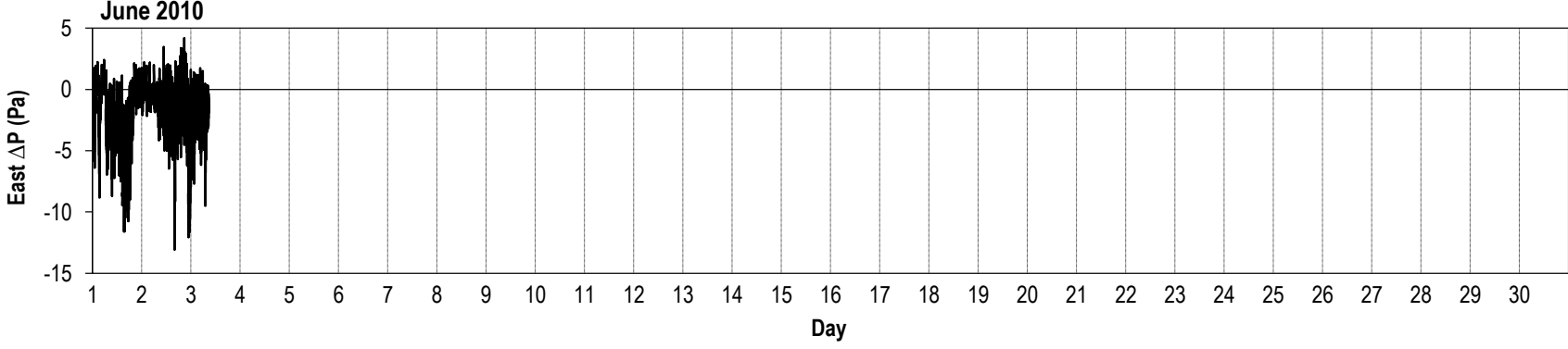
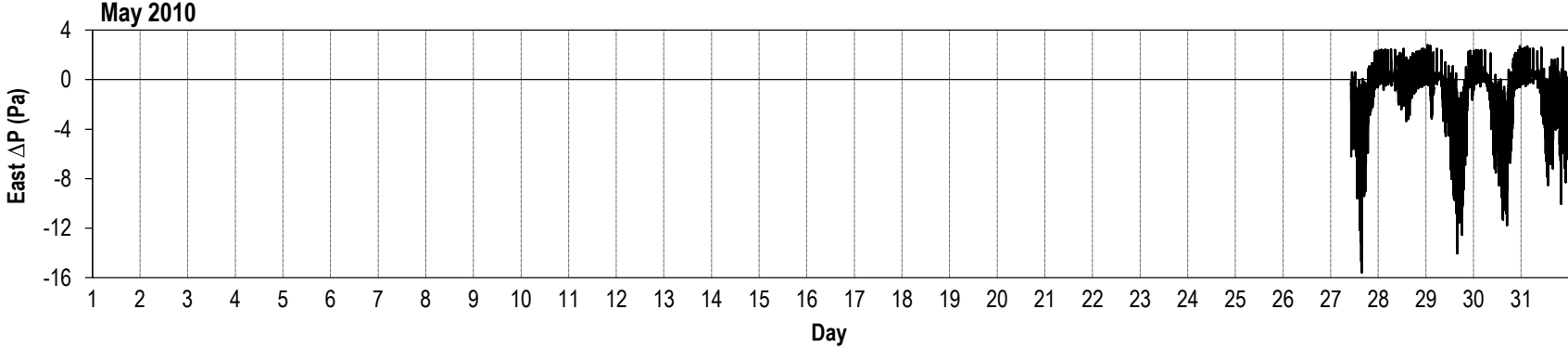

Notes:
a. Data missing due to equipment malfunction.

- b. July measurements obtained while Syracuse University pressurized the test hut to characterize the air leakage of wall panels are not included in the graph above.

Pressure differential (Pa) across the south side of the test hut

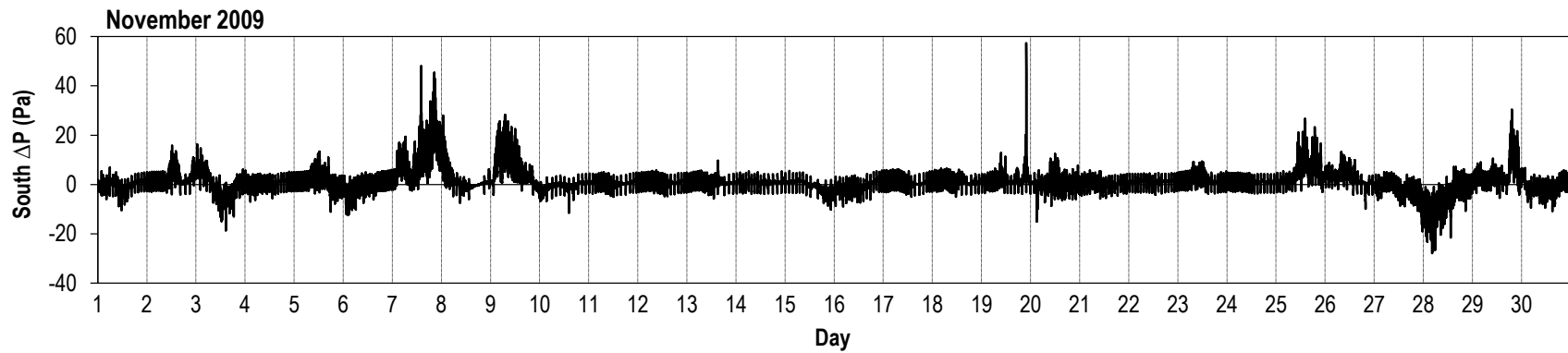
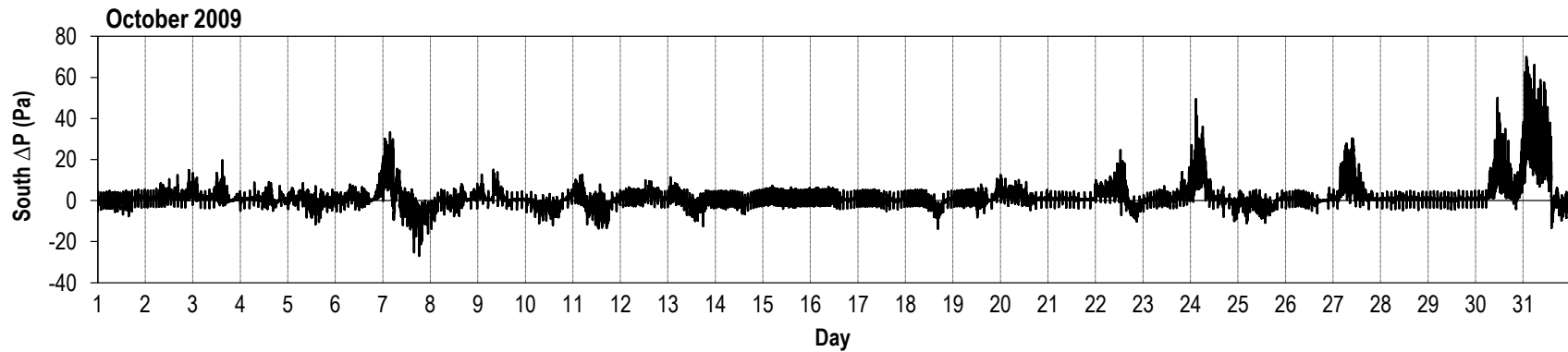
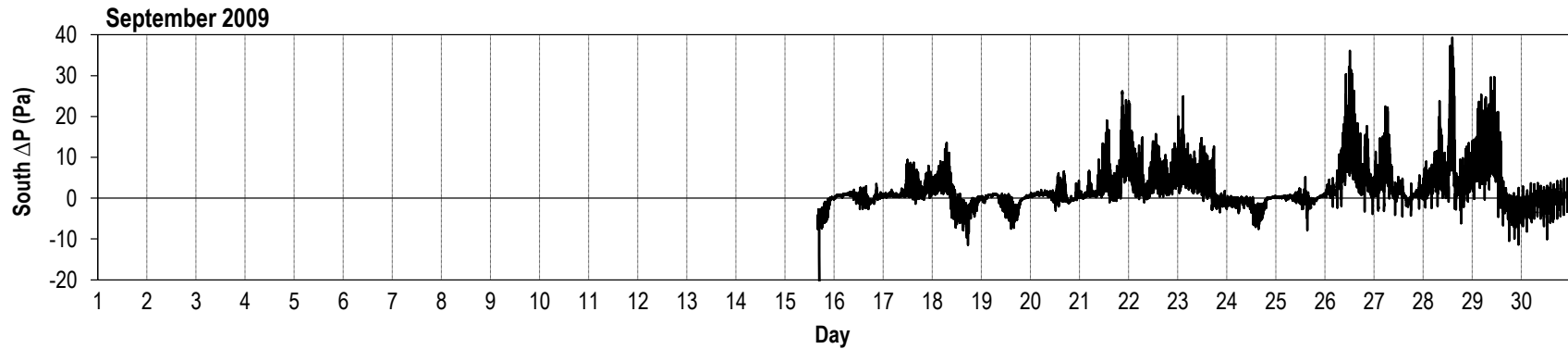

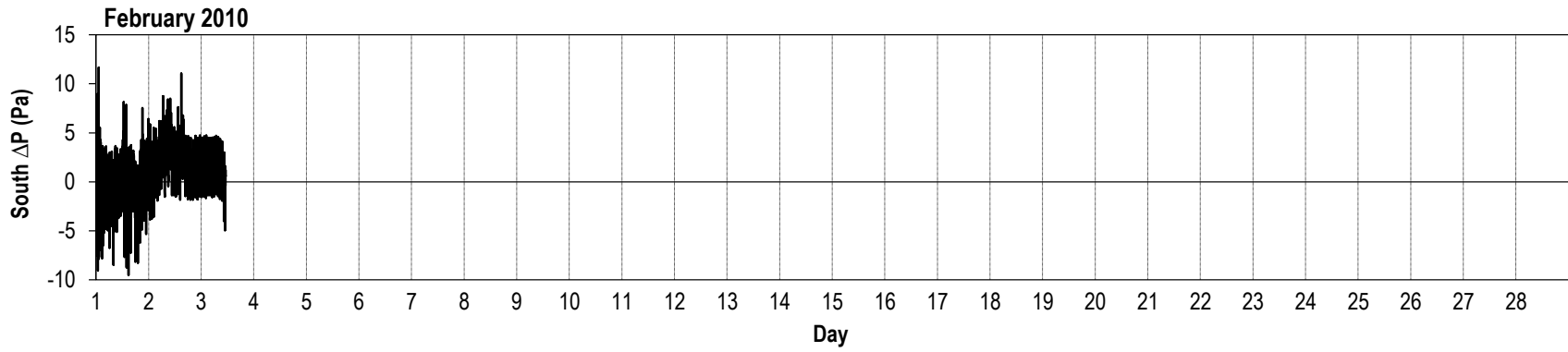
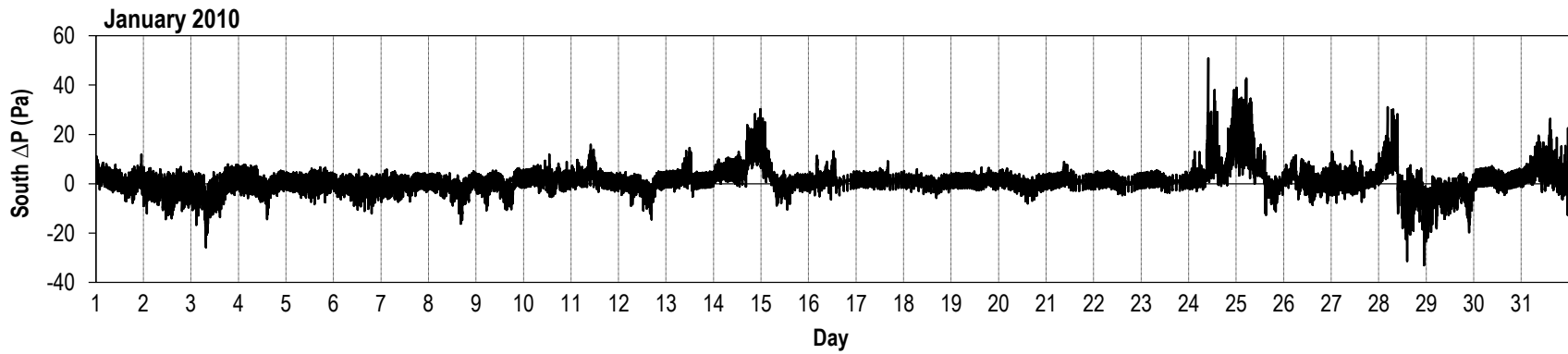
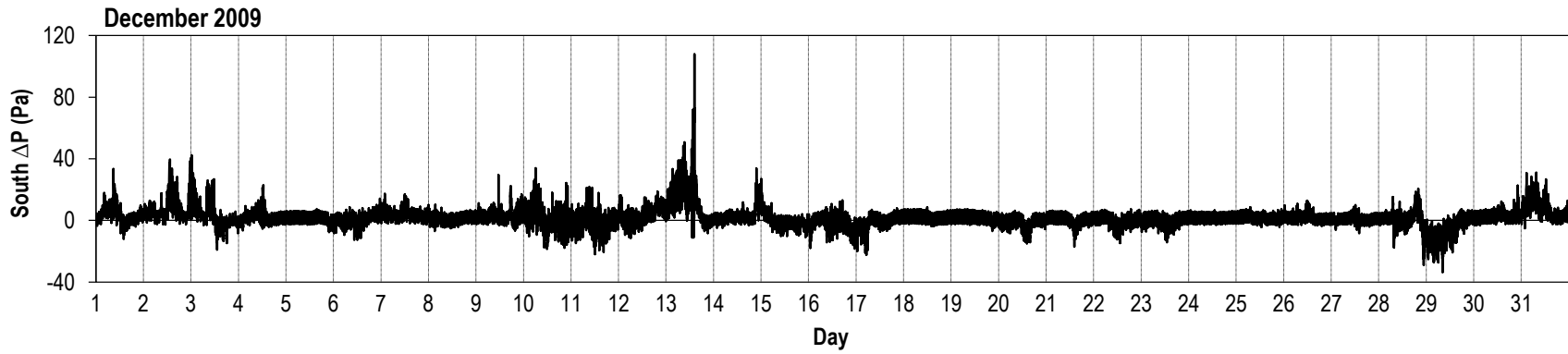

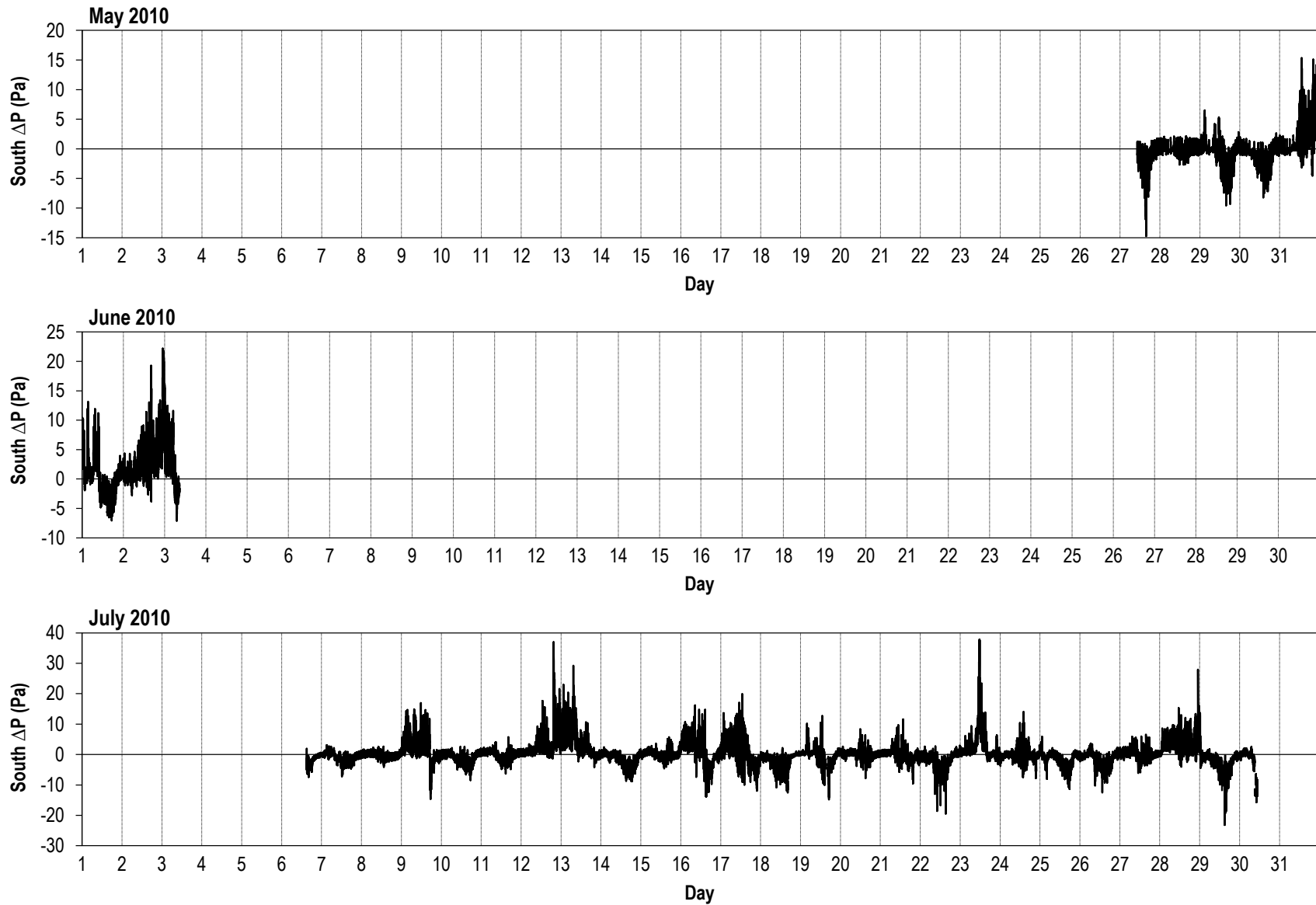

Notes:

- a. Data missing due to equipment malfunction.
- b. July measurements obtained while Syracuse University pressurized the test hut to characterize the air leakage of wall panels are not included in the graph above.

Pressure differential (Pa) across the west side of the test hut

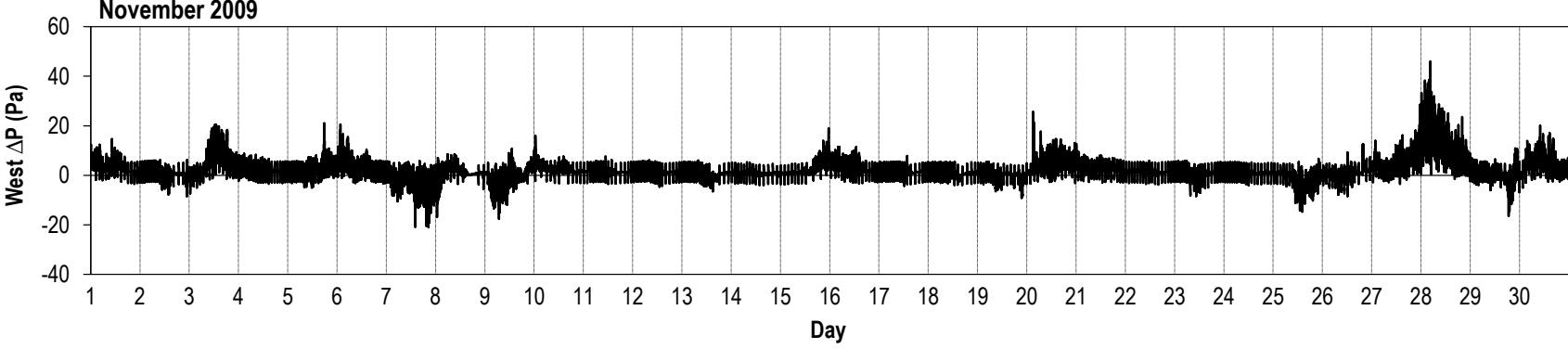
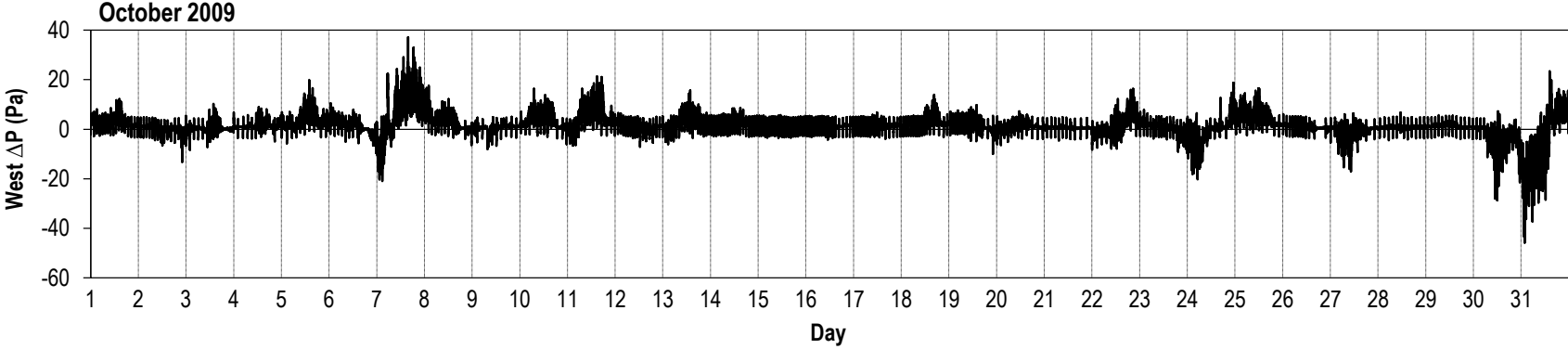
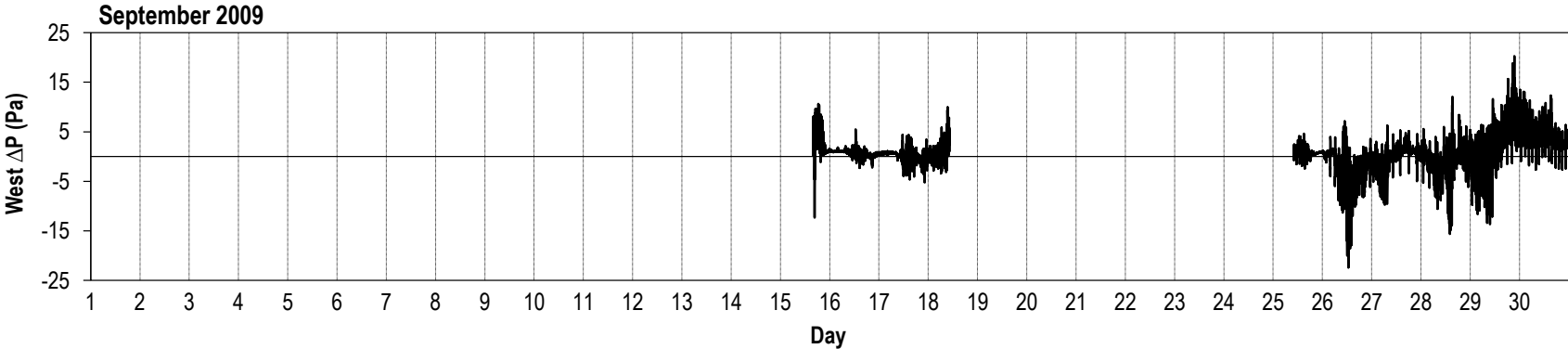

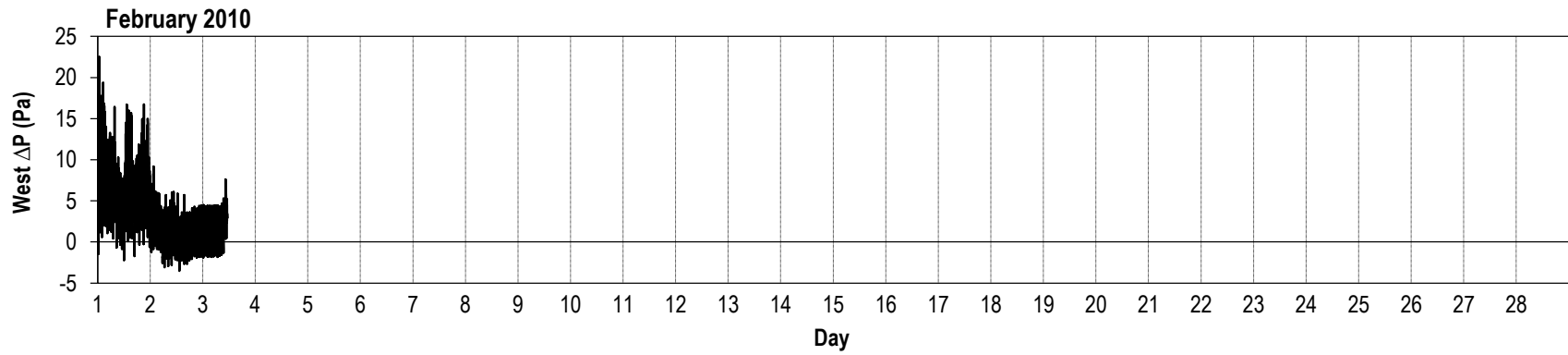
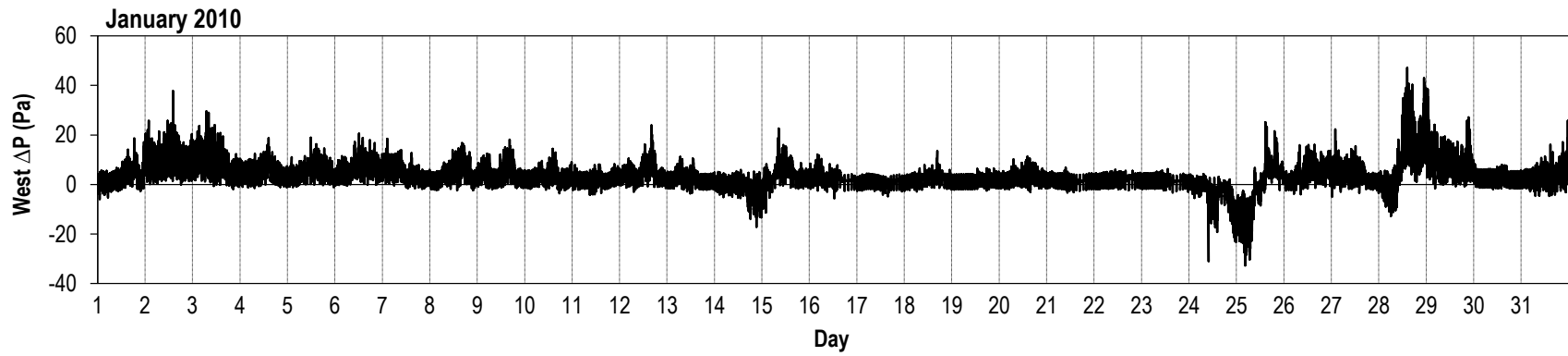
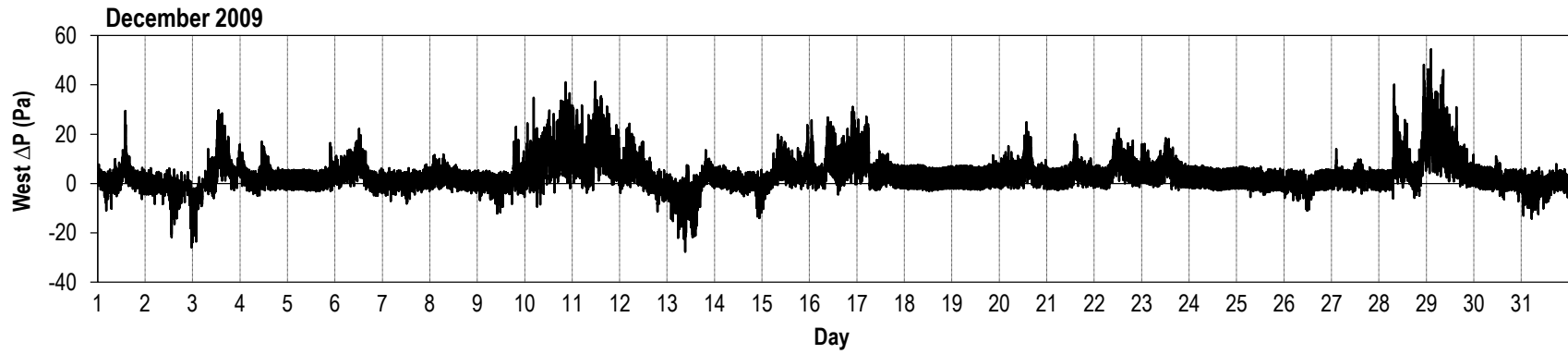

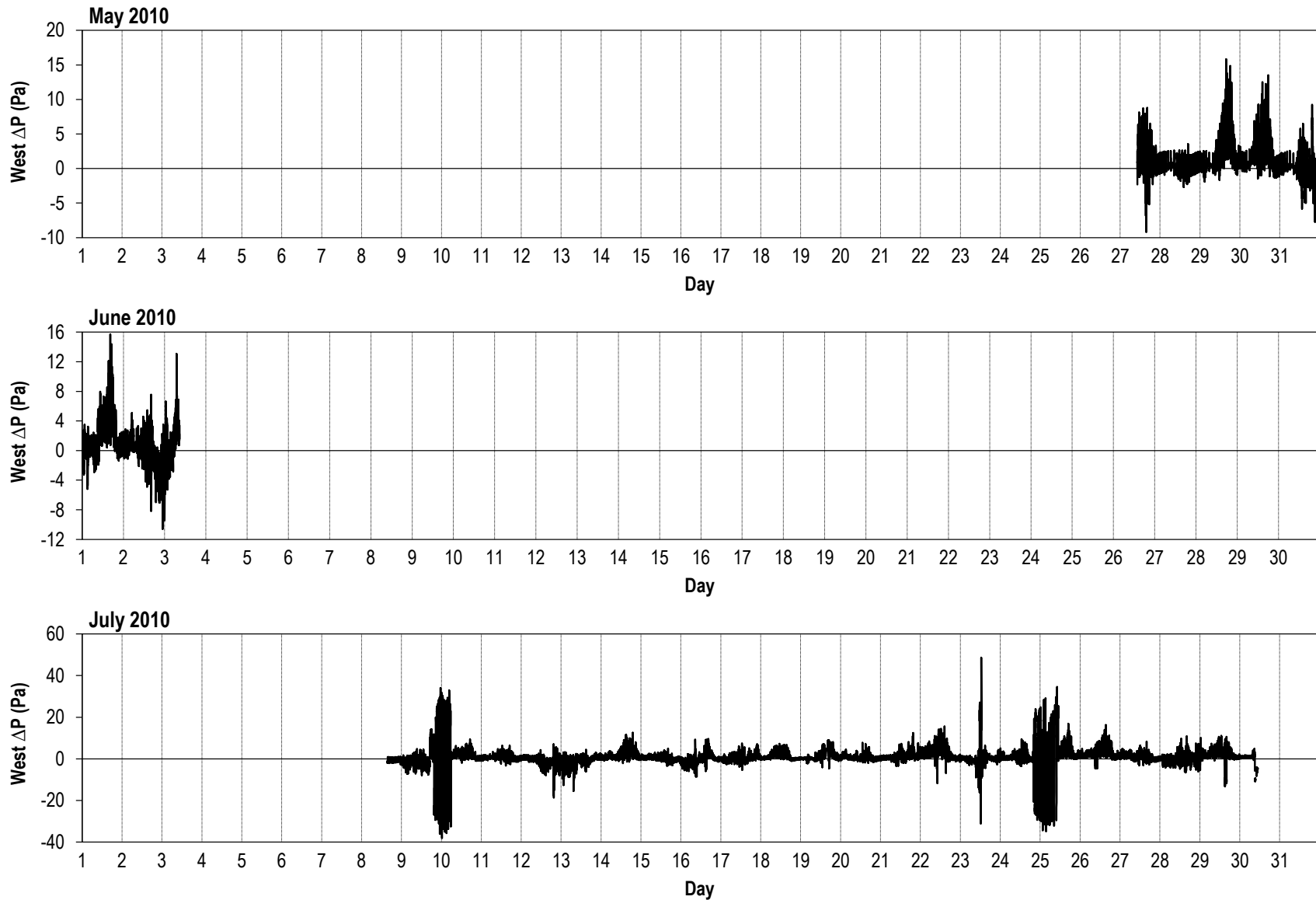

Notes:

- a. Data missing due to equipment malfunction.
- b. July measurements obtained while Syracuse University pressurized the test hut to characterize the air leakage of wall panels are not included in the graph above.